

MODEL W1730 OSCILLATING EDGE SANDER



INSTRUCTION MANUAL

(FOR MODELS MANUFACTURED SINCE 10/11)

Phone: 1-360-734-3482 • On-Line Technical Support: tech-support@shopfox.biz

COPYRIGHT © SEPTEMBER, 2004 BY WOODSTOCK INTERNATIONAL, INC., REVISED NOVEMBER, 2011 (TS)

WARNING: NO PORTION OF THIS MANUAL MAY BE REPRODUCED IN ANY SHAPE OR FORM WITHOUT

THE WRITTEN APPROVAL OF WOODSTOCK INTERNATIONAL, INC.



WARNING!

This manual provides critical safety instructions on the proper setup, operation, maintenance, and service of this machine/tool. Save this document, refer to it often, and use it to instruct other operators.

Failure to read, understand and follow the instructions in this manual may result in fire or serious personal injury—including amputation, electrocution, or death.

The owner of this machine/tool is solely responsible for its safe use. This responsibility includes but is not limited to proper installation in a safe environment, personnel training and usage authorization, proper inspection and maintenance, manual availability and comprehension, application of safety devices, cutting/sanding/grinding tool integrity, and the usage of personal protective equipment.

The manufacturer will not be held liable for injury or property damage from negligence, improper training, machine modifications or misuse.



WARNING!

Some dust created by power sanding, sawing, grinding, drilling, and other construction activities contains chemicals known to the State of California to cause cancer, birth defects or other reproductive harm. Some examples of these chemicals are:

- Lead from lead-based paints.
- Crystalline silica from bricks, cement and other masonry products.
- Arsenic and chromium from chemically-treated lumber.

Your risk from these exposures varies, depending on how often you do this type of work. To reduce your exposure to these chemicals: Work in a well ventilated area, and work with approved safety equipment, such as those dust masks that are specially designed to filter out microscopic particles.

Table of Contents

Table of Contents	1	MAINTENANCE	22
INTRODUCTION	2	General	22
Woodstock Technical Support	2	Cleaning	22
About Your New W1730 Oscillating Edge Sander.....	2	Table & Base	22
Specifications	2	Lubrication	23
Controls and Features	3	Spindle Connector.....	24
SAFETY	4	Eccentric	24
Standard Machinery Safety Instructions	4	Calibrating Angle Gauge	26
Additional Safety for Oscillating Edge Sanders	6	Removing Drive Roller	27
Avoiding Potential Injuries.....	7	W1730 Wiring Diagram	28
ELECTRICAL	8	Troubleshooting.....	29
Circuit Requirements	8	WARRANTY	37
Grounding Requirements.....	9		
Extension Cords	9		
SET UP	10		
Unpacking	10		
Items Needed for Set Up.....	10		
Inventory	11		
Machine Placement	12		
Cleaning Machine.....	12		
Sanding Belt.....	13		
Backstop	13		
Dust Port.....	14		
Dust Port Door	14		
Dust Port Cover.....	14		
Sanding Spindle.....	15		
Dust Collection	16		
Gear Box.....	16		
Test Run.....	16		
Belt Tracking	17		
Emergency Stop Button	18		
Platen Angle Adjustment.....	19		
Table Adjustment.....	19		
Miter Gauge	20		
Fence.....	20		
Spindle Table Height.....	20		
Spindle Sanding.....	21		
End & Edge Sanding.....	21		

USE THE QUICK GUIDE PAGE LABELS TO SEARCH OUT INFORMATION FAST!



INTRODUCTION

Woodstock Technical Support

We stand behind our machines! In the event that questions arise about your machine, parts are missing, or a defect is found, please contact Woodstock International Technical Support at 1-360-734-3482 or send e-mail to: tech-support@shopfox.biz. Our knowledgeable staff will help you troubleshoot problems, send out parts or arrange warranty returns.

If you need the latest edition of this manual, you can download it from <http://www.shopfox.biz>. If you still have questions after reading the latest manual, or if you have comments please contact us at:

Woodstock International, Inc.
Attn: Technical Support Department
P.O. Box 2309
Bellingham, WA 98227

About Your New W1730 Oscillating Edge Sander

Your new SHOP FOX® W1730 Oscillating Edge Sander has been specially designed to provide many years of trouble-free service. Close attention to detail, ruggedly built parts, and a discerning quality control program assure safe and reliable operation.

This W1730 Oscillating Edge Sander has a vertically and horizontally adjustable table and a 0°-90° tilting platen, for a full range of adjustment for custom applications. The Model W1730 has a 2 HP motor, and vertically oscillates the 6" x 89" belt three-quarters of an inch fifty-two times per minute. The cast iron auxiliary table provides space for edge sanding as well as spindle sanding with the spindle sanding attachment. Complementing features to best utilize the adjustment range of the Model W1730 are a T-slot cast iron table, a 180° adjustable miter gauge, and a powder coated removable fence.

Woodstock International, Inc. is committed to customer satisfaction in providing this manual. It is our intent to make sure all the information necessary for safety, ease of assembly, practical use and durability of this product be included.

Specifications

Motor	2 HP, 9A, 240V, Single-Phase
Main Table	26-7/8" x 12", Cast Iron
Auxiliary Table	10" x 11-1/2"
Belt Size.....	6" x 89"
Belt Speed	3150 FPM
Belt Oscillation Stroke	3/4"
Belt Oscillation Cycle.....	52 Cycles/Minute
Platen	Steel w/Graphite Pad
Platen Tilt.....	0°-90°
Spindle Drums (3).....	1-1/2", 2", 3"
Dust Port Size	4"
Approximate Machine Weight	396 lbs.

Controls and Features

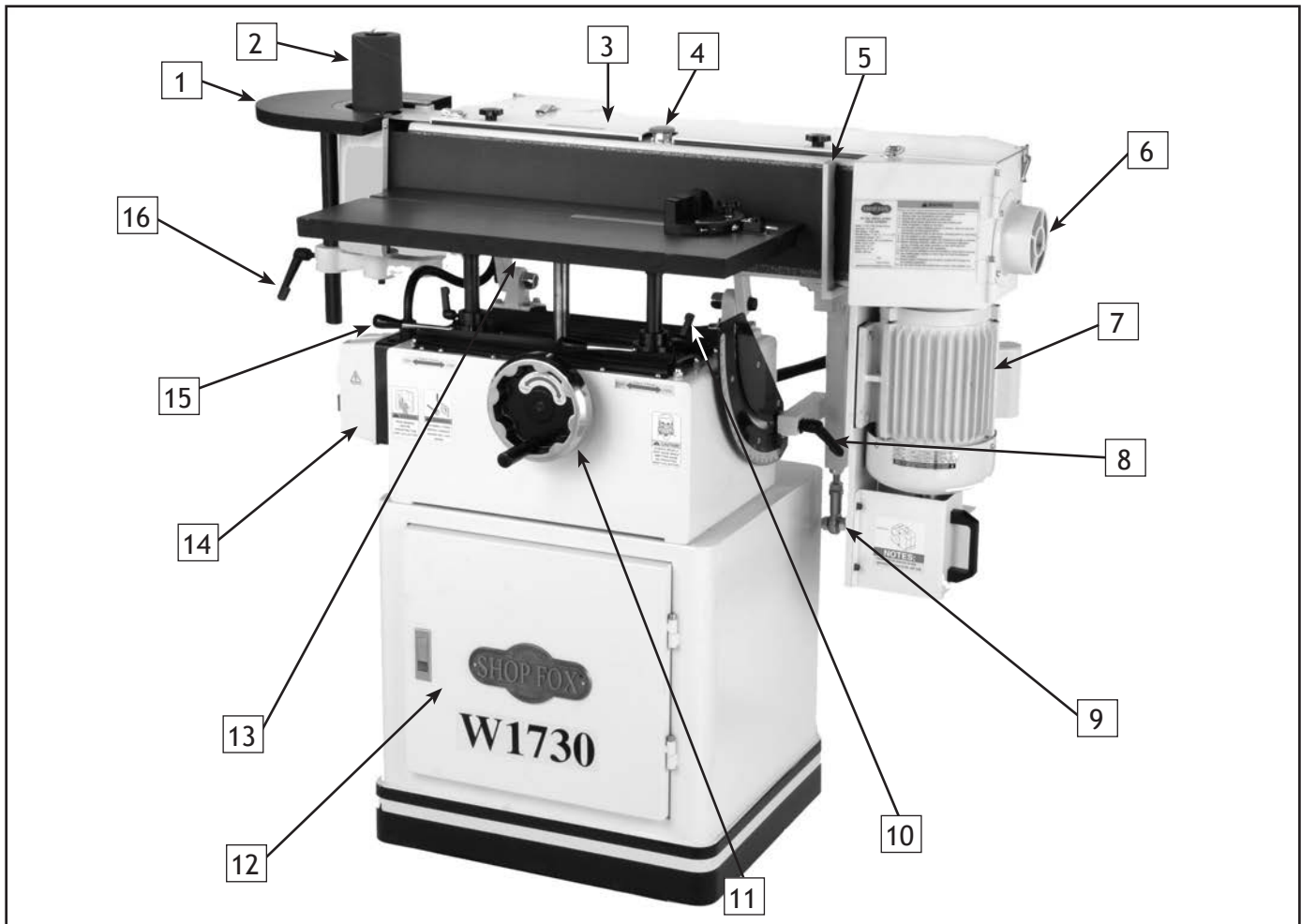

Figure 1. Controls and Features of the W1730.

- | | |
|-----------------------------------|--|
| 1. Sanding Spindle Table | 9. Belt Tracking Adjustment |
| 2. Sanding Spindle | 10. Vertical Adjustment Lock Handles |
| 3. Belt Access Door | 11. Vertical Adjustment Handwheel |
| 4. Emergency Stop Switch | 12. Storage Compartment |
| 5. Back Stop | 13. Sanding Table |
| 6. Dust Port | 14. ON/OFF Switch |
| 7. Motor | 15. Table Lock Levers |
| 8. Angle Adjustment & Lock Handle | 16. Spindle Table Adjustment Lock Handle |

WARNING

For Your Own Safety Read Instruction Manual Before Operating Saw

- a) **Wear eye protection.**
- b) **Support workpiece with miter gauge, backstop or worktable.**
- c) **Maintain 1/16" in maximum clearance between table and sanding belt.**
- d) **Avoid kickback by sanding in accordance with the directional arrows.**

SAFETY

For Your Own Safety, Read Manual Before Operating Machine

SAFETY

The purpose of safety symbols is to attract your attention to possible hazardous conditions. This manual uses a series of symbols and signal words intended to convey the level of importance of the safety messages. The progression of symbols is described below. Remember that safety messages by themselves do not eliminate danger and are not a substitute for proper accident prevention measures—this responsibility is ultimately up to the operator!



Indicates an imminently hazardous situation which, if not avoided, **WILL** result in death or serious injury.



Indicates a potentially hazardous situation which, if not avoided, **COULD** result in death or serious injury.



Indicates a potentially hazardous situation which, if not avoided, **MAY** result in minor or moderate injury.

NOTICE

This symbol is used to alert the user to useful information about proper operation of the equipment, and/or a situation that may cause damage to the machinery.

Standard Machinery Safety Instructions

OWNER'S MANUAL. Read and understand this owner's manual **BEFORE** using machine. Untrained users can be seriously hurt.

EYE PROTECTION. Always wear ANSI-approved safety glasses or a face shield when operating or observing machinery to reduce the risk of eye injury or blindness from flying particles. Everyday eyeglasses are not approved safety glasses.

HAZARDOUS DUST. Dust created while using machinery may cause cancer, birth defects, or long-term respiratory damage. Be aware of dust hazards associated with workpiece materials, and always wear a NIOSH-approved respirator to reduce your risk.

WEARING PROPER APPAREL. Do not wear clothing, apparel, or jewelry that can become entangled in moving parts. Always tie back or cover long hair. Wear non-slip footwear to avoid accidental slips which could cause a loss of workpiece control.

HEARING PROTECTION. Always wear hearing protection when operating or observing loud machinery. Extended exposure to this noise without hearing protection can cause permanent hearing loss.

MENTAL ALERTNESS. Be mentally alert when running machinery. Never operate under the influence of drugs or alcohol, when tired, or when distracted.

DISCONNECTING POWER SUPPLY. Always disconnect machine from power supply before servicing, adjusting, or changing cutting tools (bits, blades, cutters, etc.). Make sure switch is in **OFF** position before reconnecting to avoid an unexpected or unintentional start.

DANGEROUS ENVIRONMENTS. Do not use machinery in wet or rainy locations, cluttered areas, around flammables, or in poorly-lit areas. Keep work area clean, dry, and well-lit to minimize risk of injury.

APPROVED OPERATION. Untrained operators can be seriously hurt by machinery. Only allow trained or properly supervised people to use machine. When machine is not being used, disconnect power, remove switch keys, or lock-out machine to prevent unauthorized use—especially around children. Make workshop kid proof!

ONLY USE AS INTENDED. Only use machine for its intended purpose. Never modify or alter machine for a purpose not intended by the manufacturer or serious injury may result!

USE RECOMMENDED ACCESSORIES. Consult this owner's manual or the manufacturer for recommended accessories. Using improper accessories will increase the risk of serious injury.

CHILDREN & BYSTANDERS. Keep children and bystanders a safe distance away from work area. Stop using machine if children or bystanders become a distraction.

REMOVE ADJUSTING TOOLS. Never leave adjustment tools, chuck keys, wrenches, etc. in or on machine—especially near moving parts. Verify removal before starting!

SECURING WORKPIECE. When required, use clamps or vises to secure workpiece. A secured workpiece protects hands and frees both of them to operate the machine.

FEED DIRECTION. Unless otherwise noted, feed work against the rotation of blades or cutters. Feeding in the same direction of rotation may pull your hand into the cut.

GUARDS & COVERS. Guards and covers can protect you from accidental contact with moving parts or flying debris. Make sure they are properly installed, undamaged, and working correctly before using machine.

STABLE MACHINE. Unexpected movement during operations greatly increases the risk of injury and loss of control. Verify machines are stable/secure and mobile bases (if used) are locked before starting.

FORCING MACHINERY. Do not force machine. It will do the job safer and better at the rate for which it was designed.

AWKWARD POSITIONS. Keep proper footing and balance at all times when operating machine. Do not overreach! Avoid awkward hand positions that make workpiece control difficult or increase the risk of accidental injury.

UNATTENDED OPERATION. Never leave machine running while unattended. Turn machine off and ensure all moving parts completely stop before walking away.

MAINTAIN WITH CARE. Follow all maintenance instructions and lubrication schedules to keep machine in good working condition. An improperly maintained machine may increase the risk of serious injury.

CHECK DAMAGED PARTS. Regularly inspect machine for damaged parts, loose bolts, mis-adjusted or mis-aligned parts, binding, or any other conditions that may affect safe operation. Always repair or replace damaged parts, wires, cords, or plugs before operating machine.

MAINTAIN POWER CORDS. When disconnecting cord-connected machines from power, grab and pull the plug—NOT the cord. Pulling the cord may damage the wires inside. Do not handle the cord/plug with wet hands. Avoid cord damage by keeping it away from heated surfaces, high traffic areas, harsh chemicals, and wet or damp locations.

EXPERIENCING DIFFICULTIES. If at any time you are experiencing difficulties performing the

Additional Safety for Oscillating Edge Sanders

SAFETY

READ MANUAL. This manual contains proper operating and safety procedures for this machine.

WORKPIECE PRESSURE. Do not jam the workpiece against the sanding surfaces. Firmly grasp the workpiece in both hands and ease it against the belt/spindle using light pressure.

CLOTHING. Do not wear loose clothing or jewelry while operating this machine. Roll up or button sleeves at the cuff, and tie back long hair.

HAND PLACEMENT. Do not place hands near, or in contact with, sanding surfaces during operation.

WORKPIECE HANDLING. Grip the workpiece with both hands, or the workpiece may be thrown from machine and cause serious personal injury.

MAINTENANCE. Perform machine inspections and maintenance promptly as required.

UNATTENDED MACHINE. Never leave the machine running unattended.

SANDING BELTS/DRUMS. Replace sanding belts and drums promptly as needed.

WORKPIECE QUANTITY. Never sand more than one piece of stock at a time.

FOREIGN MATERIAL. Always inspect stock for nails, staples, knots, and other imperfections that could be dislodged and thrown from the machine during sanding operations.

DUST COLLECTION. Never operate the sander without an adequate dust collection system in place and running.

DIRECTION. Never sand tapered or pointed stock with the point facing the feed direction, or the workpiece may be thrown from machine and cause serious personal injury.

POWER DISCONNECT. Disconnect the machine from the power source before changing the sanding belt or sleeve.

TEST RUN. Test run the machine before starting any work.

	<p>! WARNING READ and understand this entire instruction manual before using this machine. Serious personal injury may occur if safety and operational information is not understood and followed. DO NOT risk your safety by not reading!</p>
--	--

<p>! CAUTION</p> <p>USE this and other machinery with caution and respect. Always consider safety first, as it applies to your individual working conditions. No list of safety guidelines can be complete—every shop environment is different. Failure to follow guidelines could result in serious personal injury, damage to equipment or poor work results.</p>
--

Avoiding Potential Injuries

SAFETY



Figure 2. DO NOT leave a gap between wood and back stop, and keep hands away from belt.

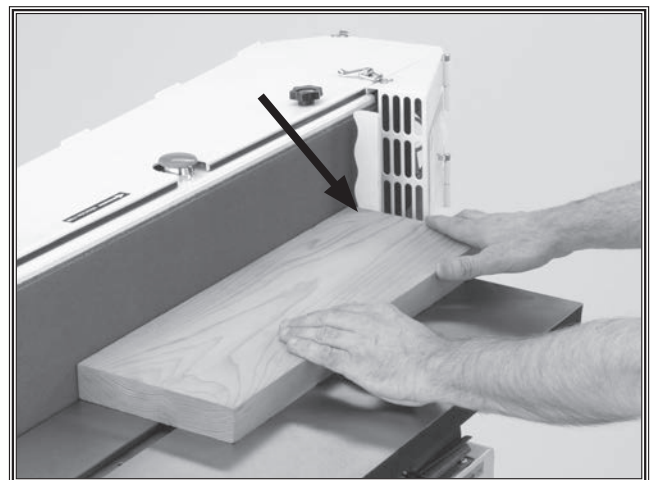

Figure 5. ALWAYS use the back stop, and keep fingers away from the belt.



Figure 3. DO NOT sand wood with fingers close to spindle.



Figure 6. ALWAYS keep your fingers away from the spindle.

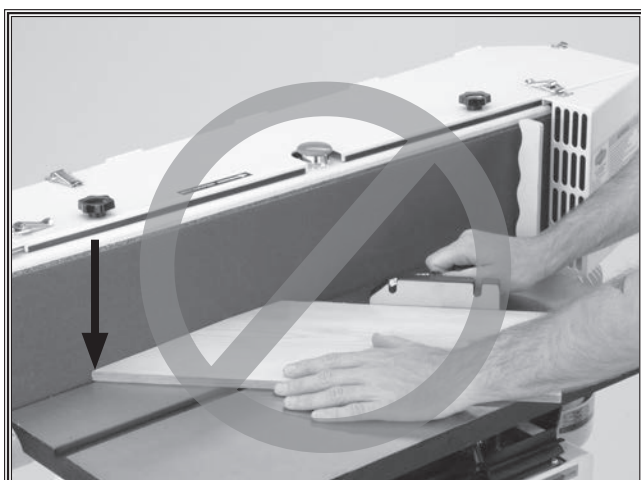

Figure 4. DO NOT sand wood with sharp corners at the leading-edge of the sanding operation. The belt can grab and throw the wood.

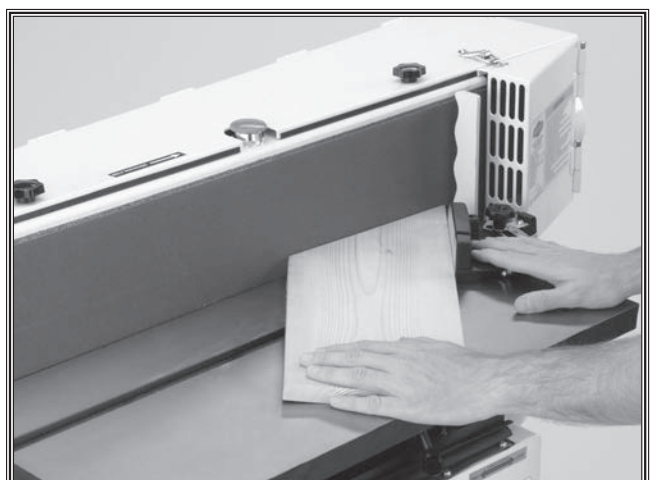

Figure 7. ALWAYS sand wood with sharp corners at the trailing-edge of the sanding operation.

ELECTRICAL

Circuit Requirements

This machine must be connected to the correct size and type of power supply circuit, or fire or electrical damage may occur. Read through this section to determine if an adequate power supply circuit is available. If a correct circuit is not available, a qualified electrician **MUST** install one before you can connect the machine to power.

A power supply circuit includes all electrical equipment between the breaker box or fuse panel in the building and the machine. The power supply circuit used for this machine must be sized to safely handle the full-load current drawn from the machine for an extended period of time. (If this machine is connected to a circuit protected by fuses, use a time delay fuse marked D.)

Full-Load Current Rating

The full-load current rating is the amperage a machine draws at 100% of the rated output power. On machines with multiple motors, this is the amperage drawn by the largest motor or sum of all motors and electrical devices that might operate at one time during normal operations.

Full-Load Current Rating at 240V9 Amps

Circuit Requirements for 240V

This machine is prewired to operate on a 220V power supply circuit that has a verified ground and meets the following requirements:

Circuit Type220V/240V, 60 Hz, Single-Phase
 Circuit Size 15 Amps
 Plug/Receptacle NEMA 6-15

SETUP

⚠ WARNING

The machine must be properly set up before it is safe to operate. **DO NOT** connect this machine to the power source until instructed to do later in this manual.

⚠ WARNING



Incorrectly wiring or grounding this machine can cause electrocution, fire, or machine damage. To reduce this risk, only an electrician or qualified service personnel should do any required electrical work on this machine.

NOTICE

The circuit requirements listed in this manual apply to a dedicated circuit—where only one machine will be running at a time. If this machine will be connected to a shared circuit where multiple machines will be running at the same time, consult a qualified electrician to ensure that the circuit is properly sized for safe operation.

Grounding Requirements

This machine **MUST** be grounded. In the event of certain types of malfunctions or breakdowns, grounding provides a path of least resistance for electric current to travel—in order to reduce the risk of electric shock.

Improper connection of the equipment-grounding wire will increase the risk of electric shock. The wire with green insulation (with/without yellow stripes) is the equipment-grounding wire. If repair or replacement of the power cord or plug is necessary, do not connect the equipment-grounding wire to a live (current carrying) terminal.

Check with a qualified electrician or service personnel if you do not understand these grounding requirements, or if you are in doubt about whether the tool is properly grounded. If you ever notice that a cord or plug is damaged or worn, disconnect it from power, and immediately replace it with a new one.

For 240V Connection

The power cord and plug specified under "Circuit Requirements for 240V" on the previous page has an equipment-grounding wire and a grounding prong. The plug must only be inserted into a matching receptacle (outlet) that is properly installed and grounded in accordance with all local codes and ordinances (see **Figure 8**).

Extension Cords

We do not recommend using an extension cord with this machine. Extension cords cause voltage drop, which may damage electrical components and shorten motor life. Voltage drop increases with longer extension cords and smaller gauge sizes (higher gauge numbers indicate smaller sizes).

Any extension cord used with this machine must contain a ground wire, match the required plug and receptacle, and meet the following requirements:

- Minimum Gauge Size at 240V 14 AWG
- Maximum Length (Shorter is Better) 50 ft.

⚠ WARNING

The machine must be properly set up before it is safe to operate. **DO NOT** connect this machine to the power source until instructed to do later in this manual.

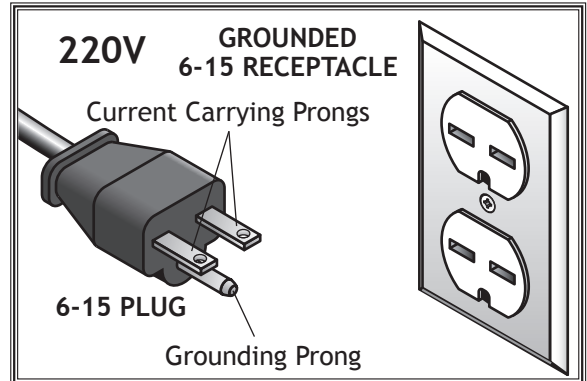

Figure 8. NEMA 6-15 plug & receptacle.

⚠ CAUTION

DO NOT modify the provided plug or use an adapter if the plug will not fit your receptacle. Instead, have a qualified electrician install the proper receptacle on a power supply circuit that meets the requirements for this machine.

SETUP

SET UP

Unpacking

The SHOP FOX® Model W1730 has been carefully packaged for safe transporting. If you notice the machine has been damaged, please contact Woodstock International Technical Support at 1-360-734-3482 or send e-mail to: tech-support@shopfox.biz

Items Needed for Set Up

The following items are needed, but not included, to setup your machine:

Description

- Phillips Screwdriver1
- Straight Slot Screwdriver.....1
- Machinist's Square1
- Hammer1
- Socket 7/8"1
- Ratchet w/6" extension1
- Hex Wrench 4mm.....1
- Dust Collector1
- Dust Hoses 4"2
- Hose Clamps 4"4

SETUP

WARNING



READ and understand this entire instruction manual before using this machine. Serious personal injury may occur if safety and operational information is not understood and followed. **DO NOT** risk your safety by not reading!

WARNING



SEEK assistance when lifting the machine from the shipping box . The Model W1730 weighs 396 lbs.

WARNING

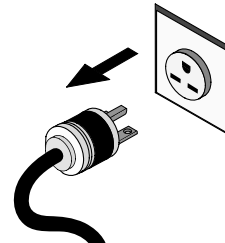

UNPLUG the power cord before you do any assembly or adjustment tasks! Otherwise, serious personal injury to you or others may occur!

Inventory

The following is a description of the main components shipped with the SHOP FOX® Model W1730. Lay the components out to inventory them.

Box Contents (Figure 9):

- A. Fence1
- B. Spindle Table Assembly1
- C. Sanding Belt1
- D. Miter Gauge1
- E. Dust Port1
- F. Back Stop1
- G. Dust Port Cover1
- H. Dust Port Door1

Box Contents Continued (Figure 10):

- I. 3" Drum1
- J. 2" Drum1
- K. 1-1/2" Drum1
- L. 3" Table Insert.....1
- M. 2" Table Insert.....1
- N. 1-1/2" Table Insert1
- O. Spindle1
- P. Hardware Bag1
 - Lock Handle1
 - Star Knob 5/16-18 x 12
 - Hex Bolt 5/16-18 x 12
 - Hex Bolt 5/16-18 x 1/2.....1
 - Phillips Head Screw 1/4-20 x 3/8".....4
 - Spindle Washer 5/16.....1
 - Flat Washer 5/16.....4
 - Hinge Pin4
 - Open End Wrench 10mm x 12mm1
 - Hex Wrench 5mm1
 - Hex Wrench 6mm1
 - Rod1
 - Drive Puller Plate1
 - Cap Screw 5/16-18 x 1-1/41
 - Cap Screw 1/4-20 x 1-3/42

If any parts appear to be missing, examine the packaging carefully. If any parts are missing, find the part number in the back of this manual and contact Woodstock International, Inc. at 360-734-3482 or at tech-support@shopfox.biz

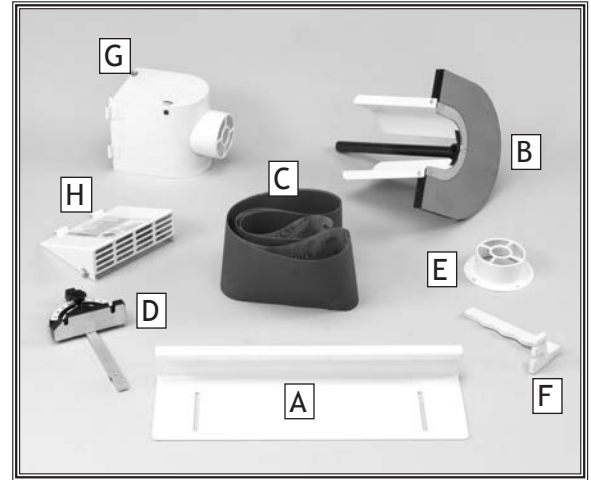

Figure 9. Box contents.

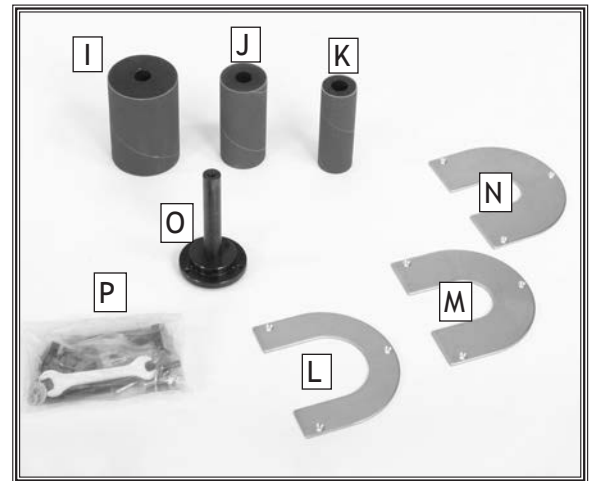
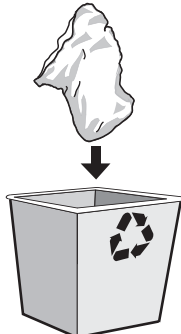

Figure 10. Box contents continued.

NOTICE

When ordering replacement parts, refer to the parts list and diagram in the back of the manual.



⚠ WARNING

SUFFOCATION HAZARD! Immediately discard all plastic bags and packing materials to eliminate choking/suffocation hazards for children and animals.

SETUP

Machine Placement

- **Floor Load:** Your Model W1730 Oscillating Edge Sander weighs 396 lbs with a 22-1/2" x 19-1/2" footprint. Some residential floors may require additional bracing to support both machine and operator.
- **Working Clearances:** Consider all existing and anticipated needs, size of material to be processed through the machine, and space for auxiliary stands, work tables, or other machinery when establishing a location for your Model W1730 Oscillating Edge Sander.
- **Electrical:** Electrical circuits should be dedicated or able to handle amperage requirements. Outlets should be located near each machine, so power cords are clear of high-traffic areas. Follow local electrical codes for proper installation of new lighting, outlets, or circuits.

SETUP

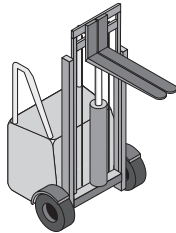

	<p>⚠️ WARNING USE helpers or power lifting equipment to lift this Model W1730 Oscillating Edge Sander. Otherwise, serious personal injury may occur.</p>
---	---

	<p>⚠️ CAUTION MAKE your shop "child safe." Ensure that your workplace is inaccessible to youngsters by closing and locking all entrances when you are away. NEVER allow untrained visitors in your shop when assembling, adjusting or operating equipment.</p>
---	---

Cleaning Machine

The table and other unpainted parts of your Model W1730 Oscillating Edge Sander are coated with a waxy grease that protects them from corrosion during shipment. Clean this grease off with a solvent cleaner or citrus-based degreaser. DO NOT use chlorine-based solvents such as brake parts cleaner or acetone—if you happen to splash some onto a painted surface, you will ruin the finish.

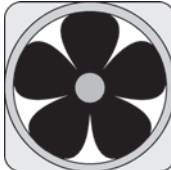
	<p>⚠️ WARNING NEVER use gasoline or other petroleum-based solvents to clean with. Most have low flash points, which make them extremely flammable. A risk of explosion and burning exists if these products are used. Serious personal injury may occur if this warning is ignored!</p>
--	--

  	<p>⚠️ CAUTION ALWAYS work in well-ventilated areas far from possible ignition sources when using solvents to clean machinery. Many solvents are toxic when inhaled or ingested. Use care when disposing of waste rags and towels to be sure they DO NOT create fire or environmental hazards.</p>
--	--

Sanding Belt

To install the belt, do these steps:

1. Open the belt access door by removing the star knobs and opening all latches.
2. Lift the belt tensioning lever as shown in **Figure 11**.
3. Determine the belt direction from the arrow on the dust port and the access door.
4. Match the arrows on the sander to the arrows inside the sanding belt, and place and center the belt on the sanding drums as shown in **Figure 12**.
5. Tension the sanding belt by pushing the belt tensioning lever down.
6. Close the belt access door, insert the star knobs, and latch the levers.
7. Adjust the belt tracking as described on **Page 17**.

Backstop

To mount the back stop, do these steps:

1. Place a 5/16" flat washer on each 5/16-18 x 1 hex bolt and thread them approximately one turn into the holes in the platen shown in **Figure 13**.
2. Slide the back stop onto the hex bolts and tighten, allowing 1/8" clearance between the belt and the edge of the back stop.

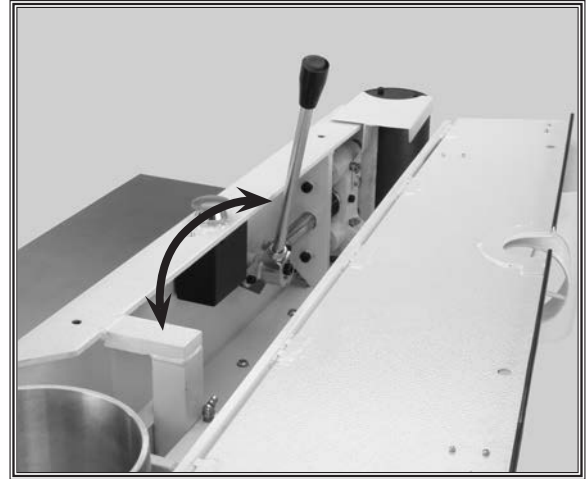

Figure 11. Released position of the belt tensioning lever.



Figure 12. Placing the sanding belt onto the sanding drums.

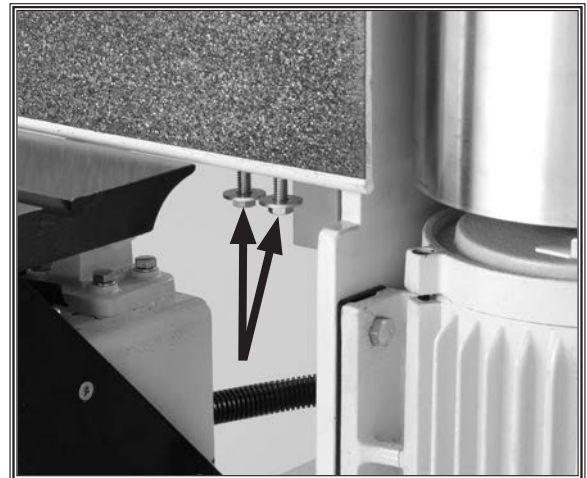

Figure 13. Backstop bolts threaded into platen.

Dust Port

To mount the dust port, do these steps:

1. Align the dust port holes with the tapped holes on the side of the sander.
2. Insert the 1/4-20 x 3/8 Phillips head screws with 1/4" washers, through the aligned holes and tighten as shown in **Figure 14**.

Dust Port Door

To mount the dust port door, do these steps:

1. Align the dust port door hinges with the hinges on the sander.
2. Insert the hinge pins through the aligned hinges, as shown in **Figure 15**, and tap with a hammer for full insertion.
3. Close and latch the dust port door.

Dust Port Cover

To mount the dust port cover, do these steps:

1. Align the dust port cover hinges with the hinges on the sander.
2. Insert the hinge pins through the aligned hinges (**Figure 16**), and tap with a hammer.
3. Shut and latch the dust port cover.



Figure 14. Dust port installation.



Figure 15. Dust port door.

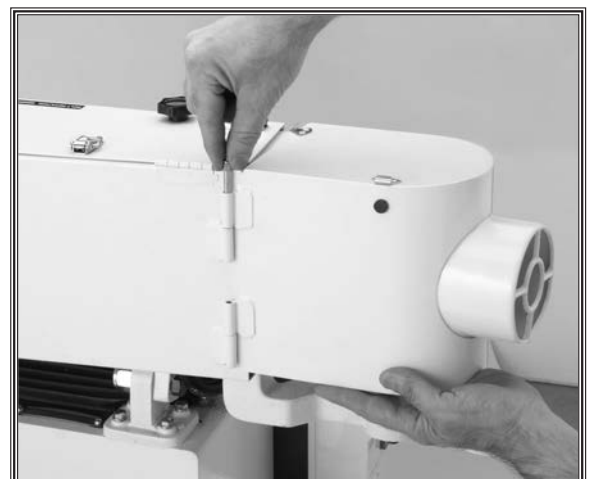

Figure 16. Inserting dust port cover hinge pin.

Sanding Spindle

The Model W1730 comes with a spindle sanding attachment for sanding curved surfaces. The included sanding drums measure 1-1/2", 2", and 3" in diameter. The spindle table may also be used on the end of the sanding belt if so desired. Be sure to periodically adjust the table height to minimize spot wear on the spindle/belt.

To install the sanding spindle, do these steps:

1. Release the dust port cover latch, open the cover, then latch the cover to the belt access door.
2. Remove the three cap screws and false cover from the sanding belt drum.
3. Line up the screw holes and place the spindle into the sanding belt drum.
4. Thread the cap screws removed in **Step 2** into the sanding belt drum and tighten evenly and securely as shown in **Figure 17**.
5. Slide a sanding drum onto the spindle, and insert the 5/16" spindle washer and 5/16-18 x 1/2 hex bolt into the top of the spindle.
6. Insert the rod into the side of the spindle to anchor it and tighten the hex bolt as shown in **Figure 18**.
7. Insert the spindle table assembly shaft into the opening in the idler roller bracket as shown in **Figure 19**.
8. Thread the table lock handle into the pre-tapped hole in the idler roller bracket. **Note:** The handle is spring loaded and can be used as a ratchet.
9. Remove the installed table insert by removing the three flat head screws in the insert.
10. Replace with the table insert that matches the sanding drum diameter. Tighten with the flat head screws removed in **Step 9**.



Figure 17. Securing the cap screws.

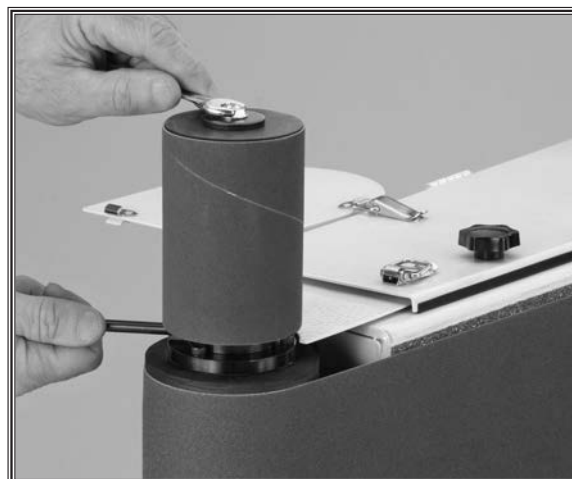

Figure 18. Anchoring the spindle with the rod.

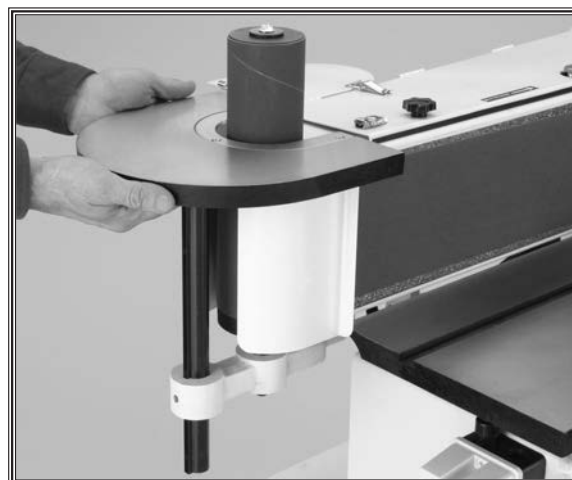

Figure 19. Inserting spindle table assembly into idler roller bracket.

Dust Collection

There are two 4" dust collection ports that should be connected to a dust collector. The port locations are shown in **Figure 20**.

To connect your machine to a dust collection system, do these steps:

1. Use a 4" diameter hose and clamps to connect a dust collection system to your dust ports.
2. Check for a snug fit by gently tugging on the hose.

Gear Box

It is vital for the gear box to be correctly filled with SAE 80W oil before any operation. The gear box is filled at the factory, but the oil level should be double checked. To check and refill the gear box, do these steps:

1. Place the belt sander in the horizontal position.
2. Locate the gear box cover, directly beneath the motor, and remove the two cap screws and two hex bolts retaining the gear box cover.
3. Remove the oil fill plug on top of the gear box (**Figure 21**) and check the oil level.
 - If the oil is within 1/2" from the top, the oil level is correct, continue to **step 4**.
 - If the oil level is not within 1/2" from the top, fill the gear box with SAE 80W gear oil until the level is 1/2" from the top.
4. Reinstall the cover, hex bolts and cap screws.

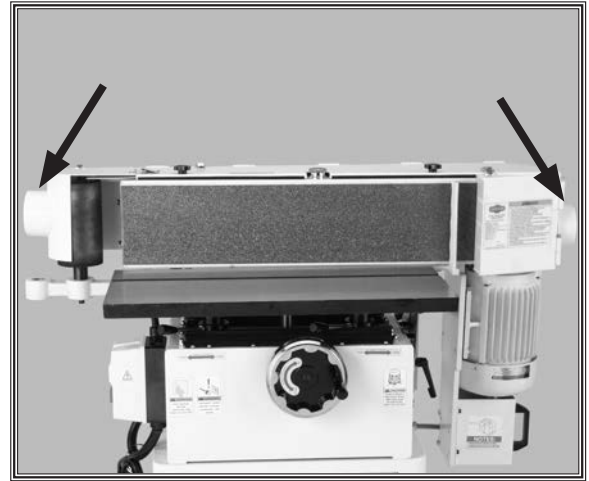

Figure 20. W1730 dust ports.

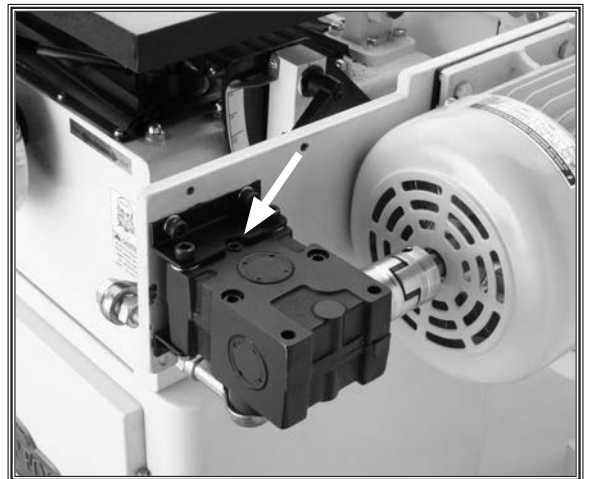

Figure 21. Checking gear box oil level.

Test Run

Once all **Set Up** procedures up to this point have been completed, it is time to test run your new sander.

Turn the machine **ON** and keep your hand poised near the switch just in case there is a problem. The machine should run smoothly with little or no vibration or rubbing noises. Turn the machine **OFF**. Strange or unnatural noises should be investigated and corrected before further operation of the machine.

If you cannot easily locate the source of unusual noise or vibration, contact Woodstock International, Inc. at 360-734-3482 or at tech-support@shopfox.biz

Belt Tracking

After the sanding belt has been removed or replaced, or used for a significant amount of time, it may be necessary to adjust the sanding belt tracking.

To adjust the sanding belt tracking, do these steps:

1. Turn the machine **ON** long enough to observe the tracking of the sanding belt, then turn it **OFF**.
2. If the sanding belt does not track on a centered path across the rollers, adjustment is necessary.
3. **Unplug the sander!**
4. Loosen the jam nut shown in **Figure 22**.
5. Determine if the sanding belt is tracking too high, or too low:
 - If the belt tracks above center, turn the adjustment nut, shown in **Figure 22**, counterclockwise.
 - If the sanding belt tracks below center, turn the adjustment nut clockwise.
6. Tighten the jam nut.
7. Connect the machine to power and turn **ON**. Observe the belt tracking behavior for at least two minutes:
 - If the belt is tracking correctly, no further adjustment is necessary.
 - If the belt is not tracking correctly, repeat **Steps 3-7**.

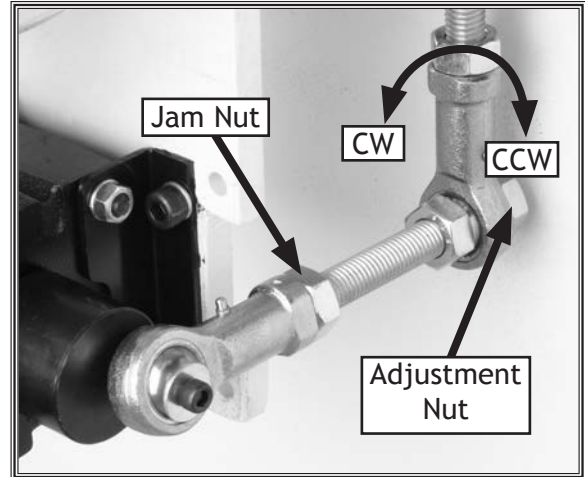
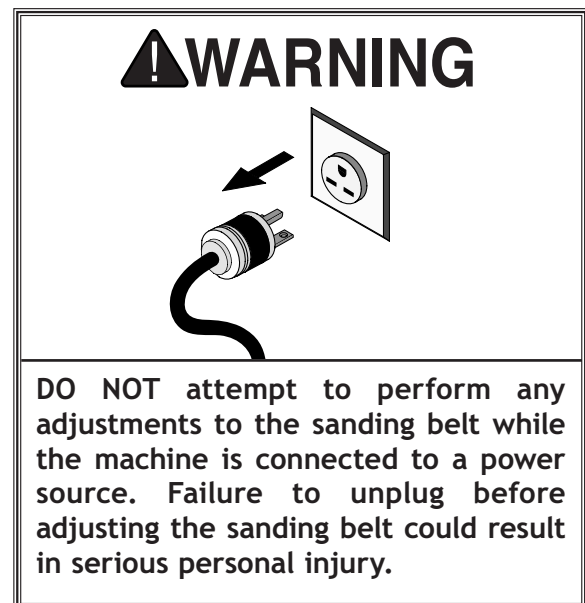

Figure 22. Jam and adjustment nuts, clockwise (CW) and Counter Clockwise (CCW) rotation.



OPERATIONS

General

Your Model W1730 will allow you to perform many types of sanding operations. However, the following section is not a complete guide to the many specialized applications of the Model W1730 Oscillating Edge Sander; nor does it include the various aftermarket products that can be used with this W1730 Oscillating Edge Sander.

We strongly recommend that you read books, trade articles or seek training with W1730 Oscillating Edge Sanders before performing any operations in which you are not confident. **Above all, your safety should come first.** This recommended research will pay off with your increased safety, the quality of your work and the gain in knowledge you will make as a woodworker.

⚠ WARNING



Always wear safety glasses when operating the Model W1730 Oscillating Edge Sander. Failure to comply may result in serious personal injury.

⚠ WARNING

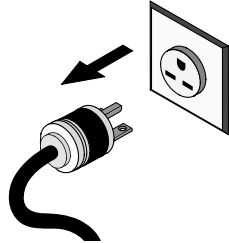

DO NOT investigate problems or adjust the Model W1730 Oscillating Edge Sander while it is running. Wait until the machine is turned off, unplugged and all working parts have come to a complete stop before proceeding!

Belt Grits

There are many types of sanding belts to choose from. We recommend aluminum oxide for general workshop environments. Below is a chart that groups abrasives into different classes and shows which grits fall into each class.

Grit	Type
24-36	Very Coarse
40-60	Coarse
80-100	Medium
120-180	Fine
220-360	Very Fine

The general rule is to sand a workpiece with progressively higher grits.

Emergency Stop Button

The Model W1730 is equipped with an emergency stop button on top of the sander. Should an emergency ever occur during use of the sander, immediately press the emergency stop button. See Figure 23 for the emergency stop button location.

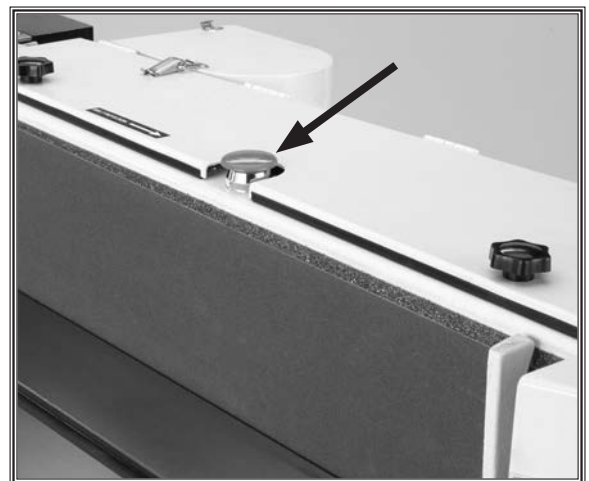

Figure 23. Emergency stop button.

Platen Angle Adjustment

The sanding angle of the oscillating edge sander is variable between 0 and 90 degrees.

To adjust the platen angle, do these steps:

1. Loosen the angle adjustment lock handle and tilt the sander until the pointer is aligned with the desired angle as shown in **Figure 24**.
2. Tighten the angle adjustment lock handle.

Note: See **Page 26** to calibrate the angle scale.



Figure 24. Platen angle scale.

Table Adjustment

The table on the oscillating edge sander moves both vertically and horizontally to accommodate various workpieces shapes and thicknesses. Adjust the table height periodically to reduce spot wear of your sanding belt.

To vertically adjust the table, do these steps:

1. Loosen the lock handles (**Figure 25**) that secure the table height position.
2. Turn the table height adjustment wheel, shown in **Figure 25**, clockwise to raise the table or counterclockwise to lower the table.
3. When the desired position is achieved, tighten the lock handles to secure the table height.

To horizontally adjust the table, do these steps:

1. Move the table lock levers to the loose position as illustrated by the labels on the machine.
2. Push or pull the table until there is a gap of no more than 1/16" from the sanding belt (**Figure 26**).
3. Move the table lock levers to the locked position to secure the table position.

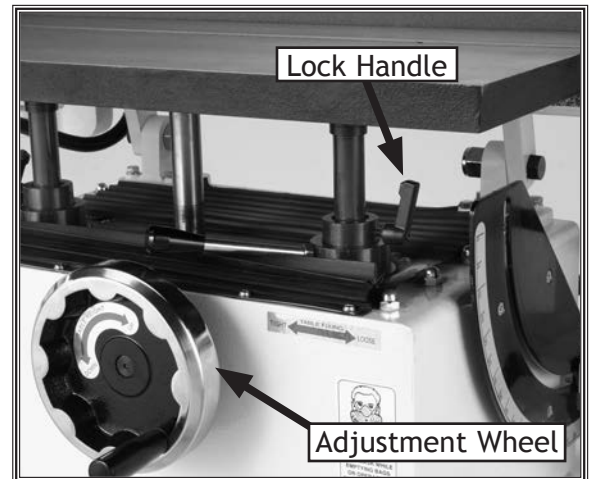

Figure 25. Vertical table adjustment.



Figure 26. Horizontal table adjustment.

Miter Gauge

To adjust the miter gauge, do these steps:

1. Use a machinist's square with one edge against the face of the miter gauge and the other against the belt face as shown in **Figure 27**.
2. Lock the lock knob on the miter gauge and adjust the miter gauge flush with the edge of the square.
3. Tighten the lock knob, and verify the setting. **Note:** Sometimes the tightening procedure can affect the adjustment.
4. Loosen the screw that secures the angle pointer and adjust the pointer to the 0° mark on the scale.
5. Retighten the screw that secures the angle pointer.

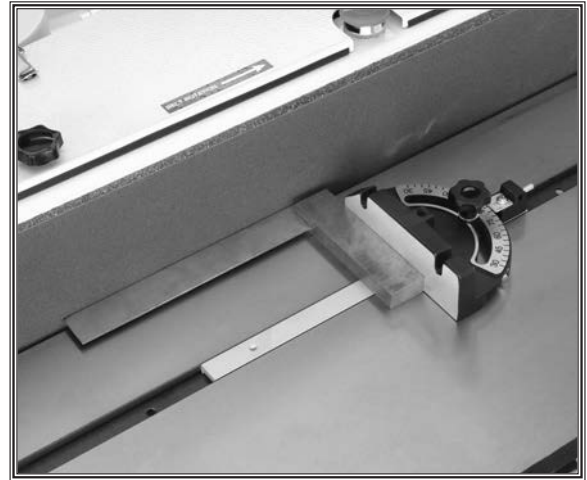

Figure 27. Squaring the miter gauge.

Fence

The Model W1730 comes with a removable fence to assist sanding operations when the platen is horizontal.

To mount the fence, do these steps:

1. Set the fence on the table and align the slots with the threaded holes in the table.
2. Thread the star knobs and 5/16" flat washers into the threaded table holes (**Figure 28**) and tighten.

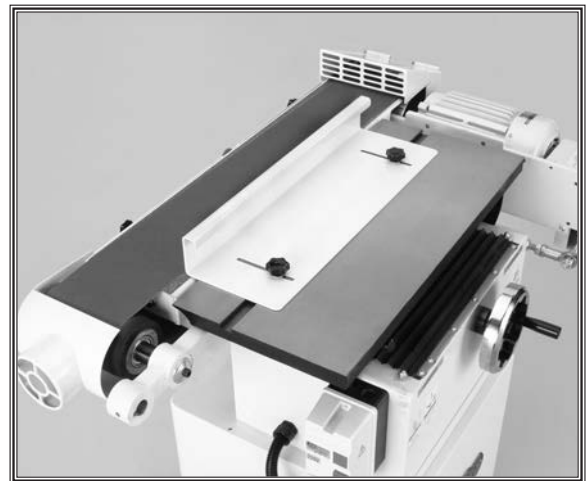

Figure 28. Installed fence.

Spindle Table Height

The spindle table on the oscillating edge sander can be moved vertically to accommodate various sanding operations and to decrease spot wear on the sanding drums.

To adjust the spindle table height, do these steps:

1. Loosen the adjustment lock handle shown in **Figure 29**.
2. Raise or lower the table to the desired height.
3. Tighten the adjustment lock handle.

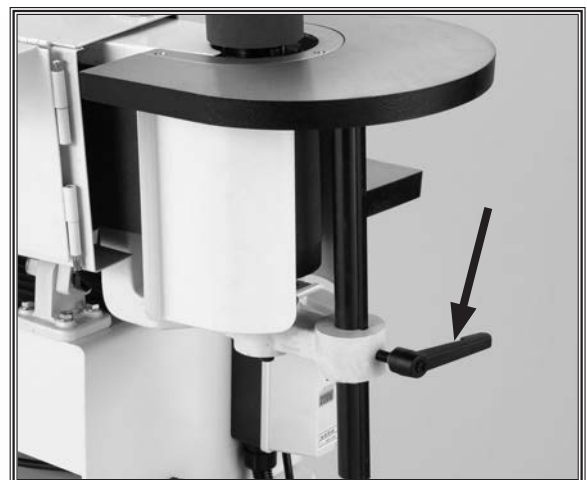

Figure 29. Adjustment lock handle.

Spindle Sanding

The spindle sander on the Model W1730 produces a high quality sanding finish on inside contours. Make sure the spindle table is properly installed with the correct table insert for the spindle drum. Move the table on occasion to reduce spot wear on the sleeves.

To perform spindle sanding operations, do these steps:

1. Make sure that the appropriate spindle and table insert have been installed correctly and both are secured tightly.
2. Position the table in the desired location and turn the power switch **ON**.
3. While securely holding the workpiece, lightly press it against the spindle and maintain consistent pressure against the table as shown in **Figure 30**. Use extra caution when sanding end-grain.
4. When you have completed your sanding operation, turn the power switch **OFF**.

End & Edge Sanding

Proper use of the oscillating edge sander will yield excellent sanding results due to the oscillating movement.

To perform an edge or end sanding operation, do these steps:

1. Start the sander by turning the switch **ON**.
2. Support the workpiece against the back stop, and slowly feed the workpiece into the moving belt, as shown in **Figure 31**. **Note:** If you must feed a workpiece into the sanding belt corner first, feed the trailing corner first. Feeding the leading corner first could cause the sanding belt to grab the workpiece and jerk it out of your hands.
3. When you have completed your sanding operation, turn the power switch **OFF**.



Figure 30. A typical spindle sanding operation.

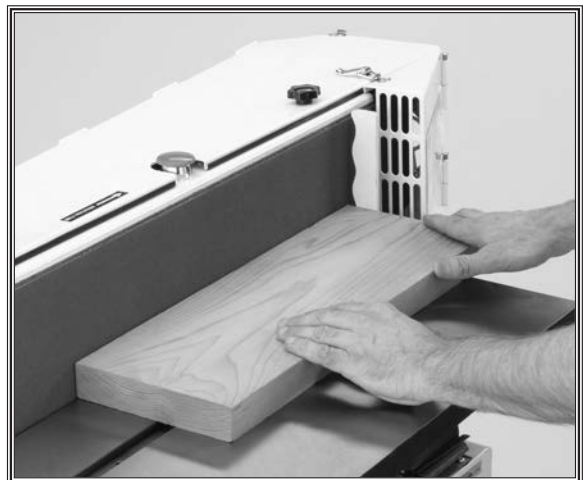

Figure 31. Edge sanding with the Model W1730.

MAINTENANCE

General

Regular periodic maintenance on your SHOP FOX® Model W1730 will ensure its optimum performance. Make a habit of inspecting your oscillating edge sander each time you use it.

Check for the following conditions and repair or replace when necessary:

- Loose mounting bolts.
- Worn or damaged sanding belts.
- Worn switch.
- Worn or damaged cords and plugs.
- Damaged V-belt.
- Any other condition that could hamper the safe operation of this machine.

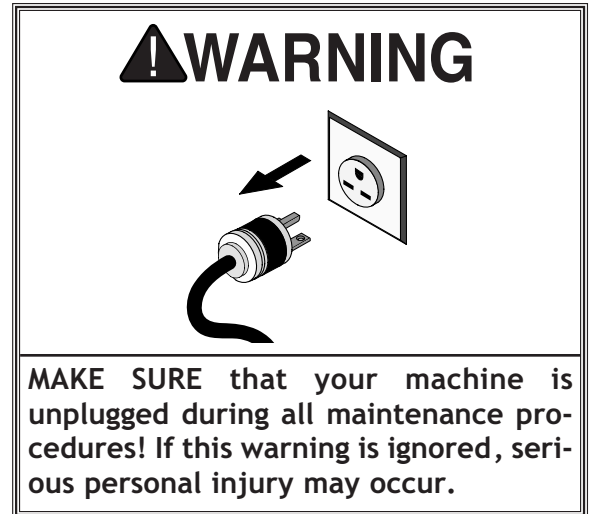

Cleaning

Frequently blow-off sawdust with compressed air. This is especially important for the internal working parts and motor. Dust build-up around the motor is a sure way to decrease its life span.

Occasionally it will become necessary to clean the internal parts with more than compressed air. To do this, remove the table top and clean the internal parts with a citrus cleaner or mineral spirits and a stiff wire brush or steel wool. Make sure the internal workings are dry before using the sander again, so that wood dust will not accumulate. If any essential lubrication is removed during cleaning, re-lubricate those areas.

Table & Base

Tables can be kept rust-free with regular applications of a product like SLIPIT®. For long term storage you may want to consider a product like Boeshield T-9™.

Lubrication

After operating the Model W1730 for approximately 500 hours, refill the gear box with oil.

To check and refill the gear box, do these steps:

1. Place the platen in the horizontal position.
2. Locate the gear box cover, directly beneath the motor, and remove the two cap screws and two hex bolts retaining the gear box cover.
3. Wipe off any dust buildup and remove the oil fill plug on top of the gear box (**Figure 32**). Fill the gear box with SAE 80W gear oil until the level is 1/2" from the top.
4. Reinstall the gear box cover with the hex bolts and cap screws.

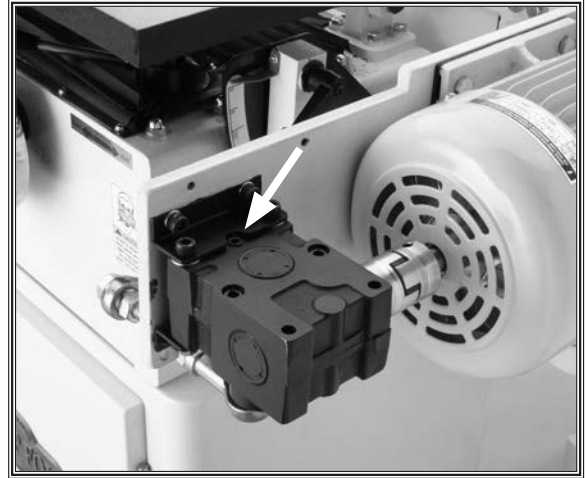

Figure 32. Gear box and oil fill on the Model W1730.

Rack & Pinion Gear

The rack and pinion gear that moves the table vertically, located inside the gear cabinet, should be well greased to maintain smooth operation.

To grease the rack and pinion gear, do these steps:

1. With the table in its lowest position, wipe the rack and pinion with a rag to remove the buildup of sawdust and old grease.
2. Apply a coat of all purpose grease to the rack and pinion gears.

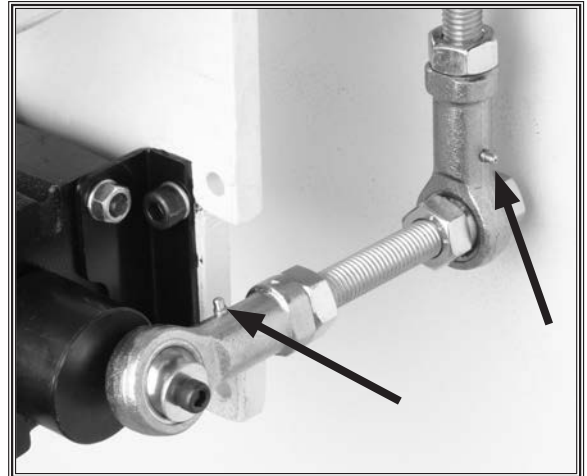

Figure 33. Oil ports.

Oil Ports & Grease Fittings

There are two oil ports shown in **Figure 33** and four grease fittings shown in **Figure 34** on the Model W1730. Lubricate these points after approximately 50 hours of use with a light machine oil.

All other bearings on the Model W1730 are sealed and permanently lubricated and there is no need to lubricate them.



Figure 34. Grease fittings.

Spindle Connector

The spindle connector connects the shafts from the motor to the gear box and is secured by two set screws that need to be tightened every time the gear box oil is filled (every 500 hours).

To secure the spindle connector set screws, do these steps:

1. Refer to **Lubrication Steps 1-3 on Page 23** to remove the gear box cover
2. Tighten the set screws shown in **Figure 35**.
3. Reinstall the gear box cover.

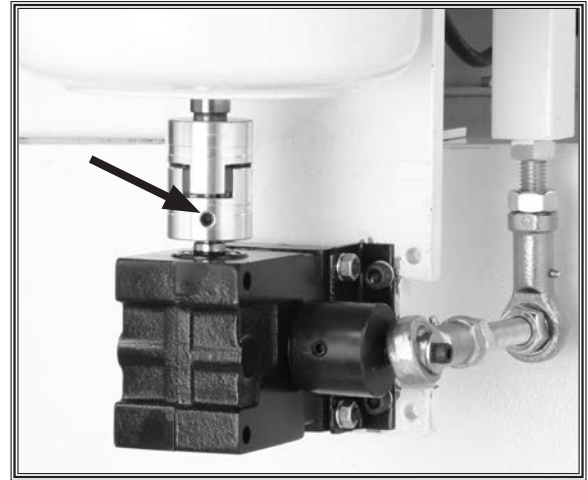

Figure 35. Spindle connector set screws.

Eccentric

The eccentric on the Model W1730 is connected to the shaft by a set screw. This set screw needs to be tightened every time the gear box oil is filled (every 500 hours).

To secure the eccentric set screw, do these steps:

1. Refer to **Lubrication, Steps 1-3 on Page 23** to remove the gear box cover.
2. Tighten the set screw on the eccentric, shown in **Figure 36**.
3. Reinstall the gear box cover.

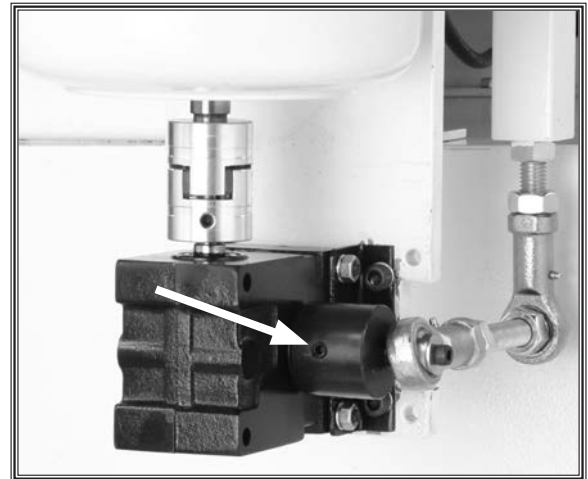

Figure 36. Eccentric set screw.



Maintenance Schedule

- Every 2 Hours of Running Time: Clean and lubricate table top, miter slot and fence.
- Every 3 Hours of Running Time: Check belt tracking. Check sanding belt condition.
- Every 6-8 Hours of Running Time: Replace belt.
- Every 2,000 hours: Replace the rubber V-Belt (recommended). Check the eccentric and spindle connector. Lubricate all oil ports and grease fittings, rack and pinion gear, and check gear box.

Maintenance Notes

DATE	MAINTENANCE PERFORMED

MAINTENANCE

SERVICE

General

This section covers the most common service adjustments or procedures that may need to be made during the life of your machine.

If you require additional machine service not covered in this section, please contact Woodstock International Technical Support for additional guidance at (360) 734-3482 or send e-mail to: tech-support@shopfox.biz.

Calibrating Angle Gauge

In order to maintain accuracy and precision with the oscillating edge sander, periodically calibrate the angle gauge.

To calibrate the angle gauge, do these steps:

1. Loosen the angle adjustment lock handle.
2. Place the machinist's square on the table and press it against the platen.
3. Adjust the platen until it is flush with the machinist's square as in **Figure 37**.
4. Tighten the angle adjustment lock handle.
5. Loosen the angle indicator pin screw, shown in **Figure 38**, a 1/2 turn.
6. Align the angle indicator pin with the 90° mark and tighten the angle indicator pin screw.

! WARNING

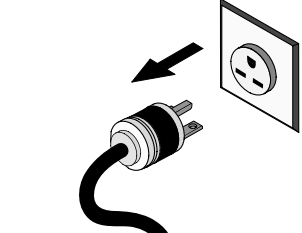

MAKE SURE that your machine is unplugged during all service procedures! If this warning is ignored, serious personal injury may occur.

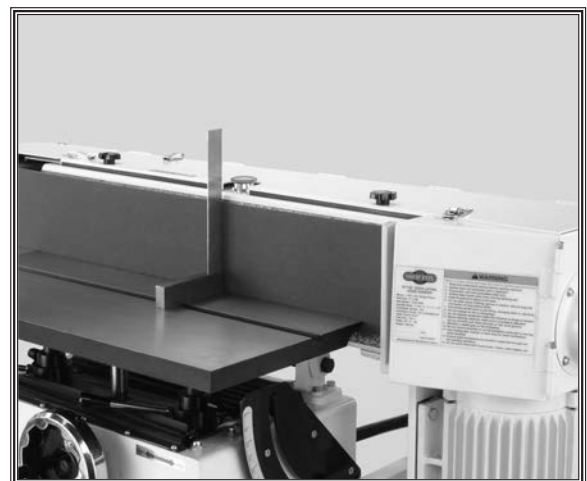

Figure 37. Aligning table to platen.

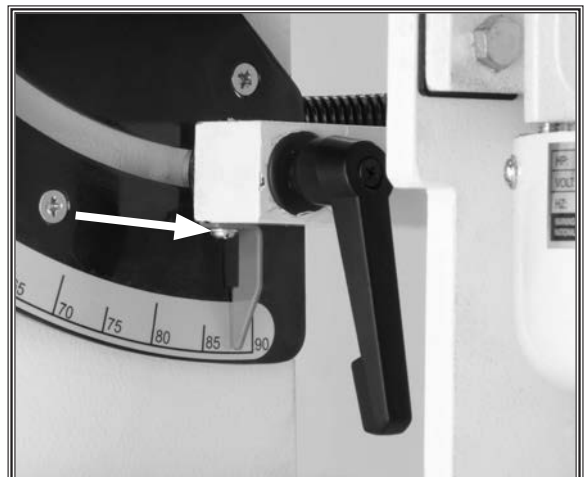

Figure 38. Angle indicator pin screw.

Removing Drive Roller

The Model W1730 comes equipped with a puller to remove the drive roller should it ever become necessary to do so.

To remove the drive roller, do these steps:

1. Remove the hex nut and lock washer securing the driver roller to the shaft.
2. Thread the two 1/4-20 x 1-3/4 cap screws on the puller four turns into the threaded holes in the drive roller.
3. Thread and tighten the 5/16-18 x 1-1/4 cap screw into the puller, shown in **Figure 39**, until the drive roller is pulled.
4. To re-install, place the drive roller on the shaft, and thread the lock washer and hex nut onto the shaft and tighten securely. **Note:** Do not hammer the drive roller onto the shaft or you will cause damage to the shaft.



Figure 39. Using the drive roller puller.

W1730 Wiring Diagram

⚠ DANGER
Disconnect power before performing any electrical service. Electricity presents serious shock hazards that will result in severe personal injury and even death!

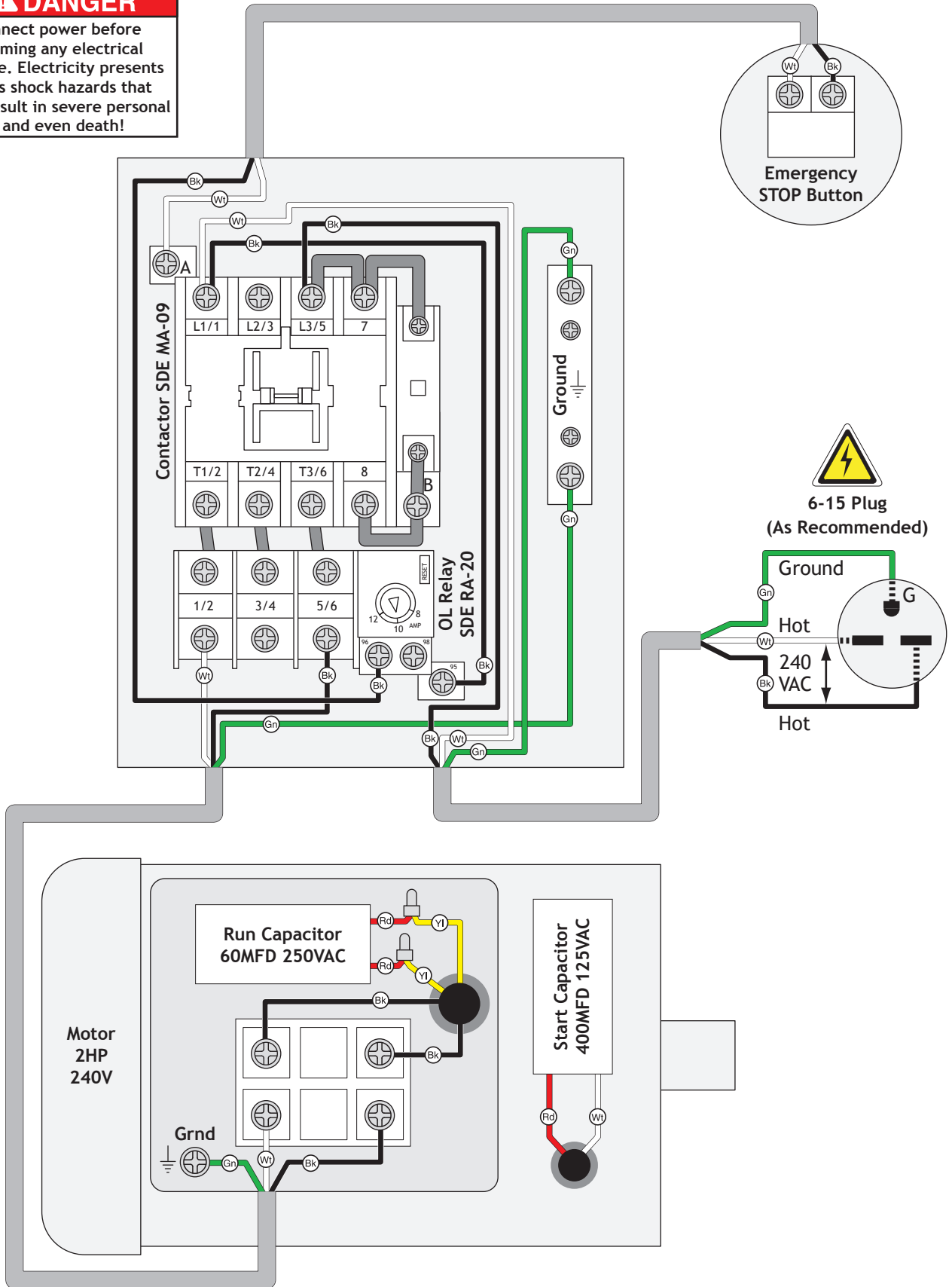

SERVICE

Troubleshooting

This section covers the most common Model W1730 Oscillating Edge Sander problems. DO NOT make any adjustments until the Model W1730 is unplugged and moving parts have come to a complete stop.

SYMPTOM	POSSIBLE CAUSE	CORRECTIVE ACTION
Motor will not start.	<ol style="list-style-type: none"> 1. Low voltage. 2. Open circuit in motor or loose connections. 	<ol style="list-style-type: none"> 1. Check power supply for proper voltage. 2. Inspect all lead connections on motor and magnetic switch for loose or open connections.
Fuses or circuit breakers trip open.	<ol style="list-style-type: none"> 1. Short circuit in line cord or plug. 2. Short circuit in motor or loose connections. 3. Incorrect fuses or circuit breakers in power supply. 	<ol style="list-style-type: none"> 1. Inspect cord or plug for damaged insulation and shorted wires and replace extension cord. 2. Inspect all connections on motor for loose or shorted terminals or worn insulation. 3. Install correct fuses or circuit breakers.
Motor overheats.	<ol style="list-style-type: none"> 1. Motor overloaded. 2. Air circulation through the motor restricted. 	<ol style="list-style-type: none"> 1. Reduce load on motor. 2. Clean out motor to provide normal air circulation.
Motor automatically shuts off (possibly resulting in blown fuse or tripped circuit breaker in the magnetic switch box, or in power supply circuit).	<ol style="list-style-type: none"> 1. Thermal Protection Circuit Breaker amperage is set too low. 2. Short circuit in motor or loose connections. 3. Low power supply voltage. 4. Incorrect fuses/circuit breakers. 	<ol style="list-style-type: none"> 1. Unplug machine, open magnetic switch cover, turn amperage dial on Thermal Protection Circuit Breaker to a higher amperage setting. 2. Inspect connections on motor for loose or shorted terminals or worn insulation. 3. Correct the low voltage condition with a qualified electrician. 4. Install correct fuses or circuit breakers.
Loud, repetitious noise coming from machine.	<ol style="list-style-type: none"> 1. Pulley setscrews or keys are missing or loose. 2. Motor fan is hitting the cover. 	<ol style="list-style-type: none"> 1. Inspect keys and setscrews. Replace or tighten if necessary. 2. Tighten fan or shim cover, or replace items.
Machine slows when operating.	<ol style="list-style-type: none"> 1. Applying too much pressure to workpiece. 2. Undersized circuit or using extension cord. 3. Run capacitor is at fault. 	<ol style="list-style-type: none"> 1. Sand with less pressure—let the movement of the belt do the work. 2. Make sure circuit wires are proper gauge & don't use extension cord! 3. Replace run capacitor.
Machine vibrates excessively	<ol style="list-style-type: none"> 1. Stand not stable on floor 2. Loose motor mounting. 3. Weak or broken tension spring. 4. Idler roller is too loose. 5. Broken/defective sanding belt. 	<ol style="list-style-type: none"> 1. Secure stand to floor, reposition to level surface, or shim the stand. 2. Check/tighten motor mounts. 3. Replace spring. 4. Adjust idler roller. 5. Replace sanding belt.
Deep sanding grooves or marks in workpiece.	<ol style="list-style-type: none"> 1. Sanding belt grit too coarse for the desired finish. 2. Workpiece is being sanded across the grain. 3. Too much sanding force on workpiece. 4. Workpiece held still against the belt. 	<ol style="list-style-type: none"> 1. Use a finer grit sanding belt. 2. Sand with the grain. 3. Reduce pressure on workpiece while sanding. 4. Keep workpiece moving while sanding on the belt.
Grains easily rub off the belt.	<ol style="list-style-type: none"> 1. Sanding belt has been stored in an incorrect environment. 2. Sanding belt has been folded or smashed. 	<ol style="list-style-type: none"> 1. Store sanding belt away from extremely dry or hot temperature. 2. Hang sanding belt or store unfolded and unstacked.

SYMPTOM	POSSIBLE CAUSE	CORRECTIVE ACTION
Glazed Sanding Belt	<ol style="list-style-type: none"> 1. Sanding wet stock. 2. Sanding stock with high residue. 	<ol style="list-style-type: none"> 1. Dry stock properly before sanding. 2. Use different stock. Or, accept the characteristics of the stock and plan on cleaning/replacing belts frequently.
Burn marks on workpiece	<ol style="list-style-type: none"> 1. Using too fine of sanding belt grit. 2. Using too much pressure against belt. 3. Work held still for too long. 	<ol style="list-style-type: none"> 1. Use a coarser grit sanding belt. 2. Reduce pressure on workpiece while sanding. 3. Do not keep workpiece in one place for too long and allow to cool.
Sanding belt clogs quickly or burns.	<ol style="list-style-type: none"> 1. Using too much pressure against belt. 2. Sanding softwood. 	<ol style="list-style-type: none"> 1. Reduce pressure one workpiece while sanding. 2. Use different stock. Or, accept the characteristics of the stock and plan on cleaning/replacing belts frequently.
Workpiece frequently get pulled out of your hand.	<ol style="list-style-type: none"> 1. Not supporting the workpiece against the stop. 2. Starting the workpiece on a leading corner. 	<ol style="list-style-type: none"> 1. Use back stop to support workpiece. 2. Start workpiece on a trailing corner.
Sanding belt comes off during operation.	<ol style="list-style-type: none"> 1. Tracking/Oscillation out of adjustment. 	<ol style="list-style-type: none"> 1. Set belt tracking as described in Setup on Page 17.

Parts Breakdown

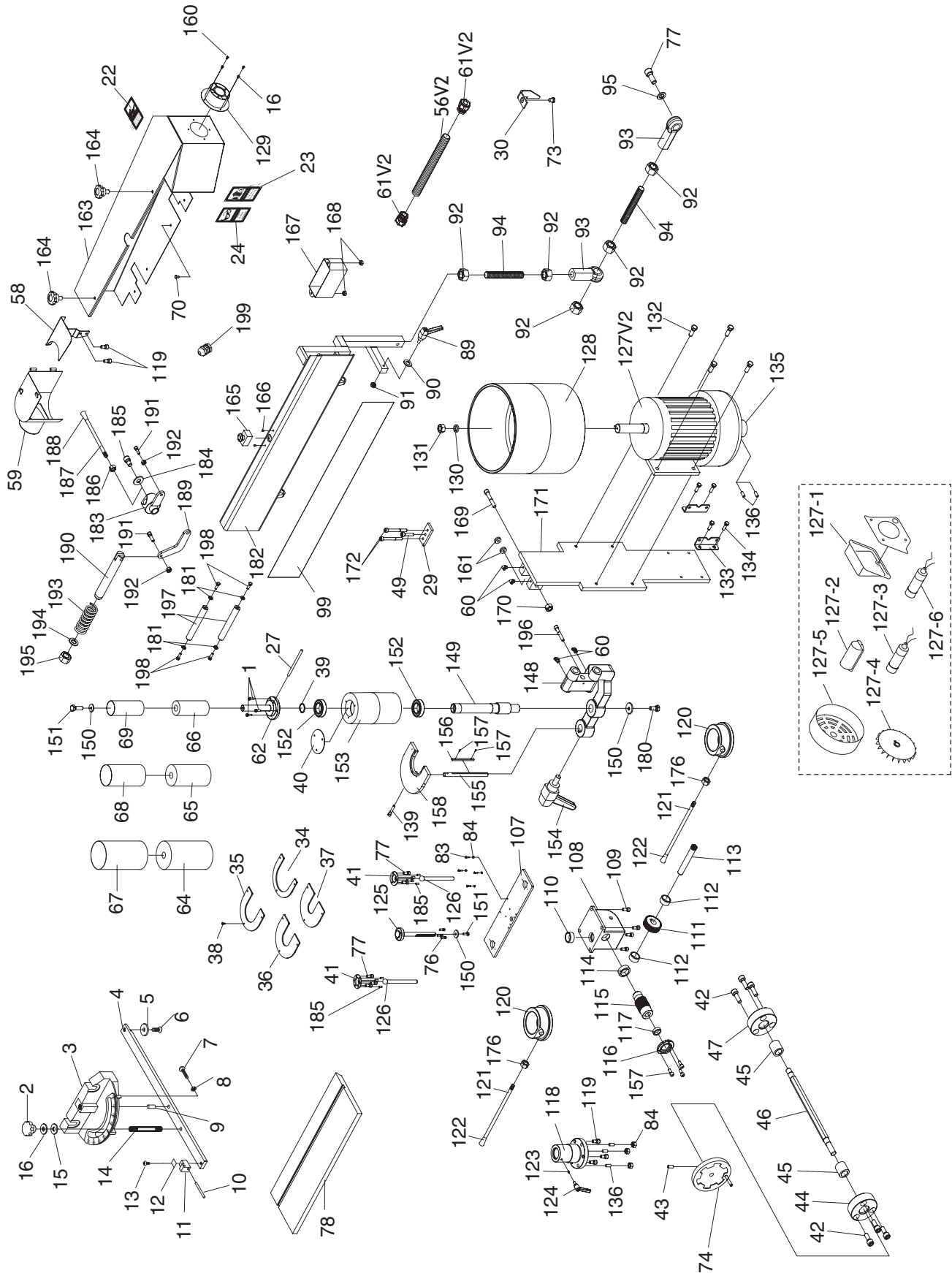

Parts Breakdown

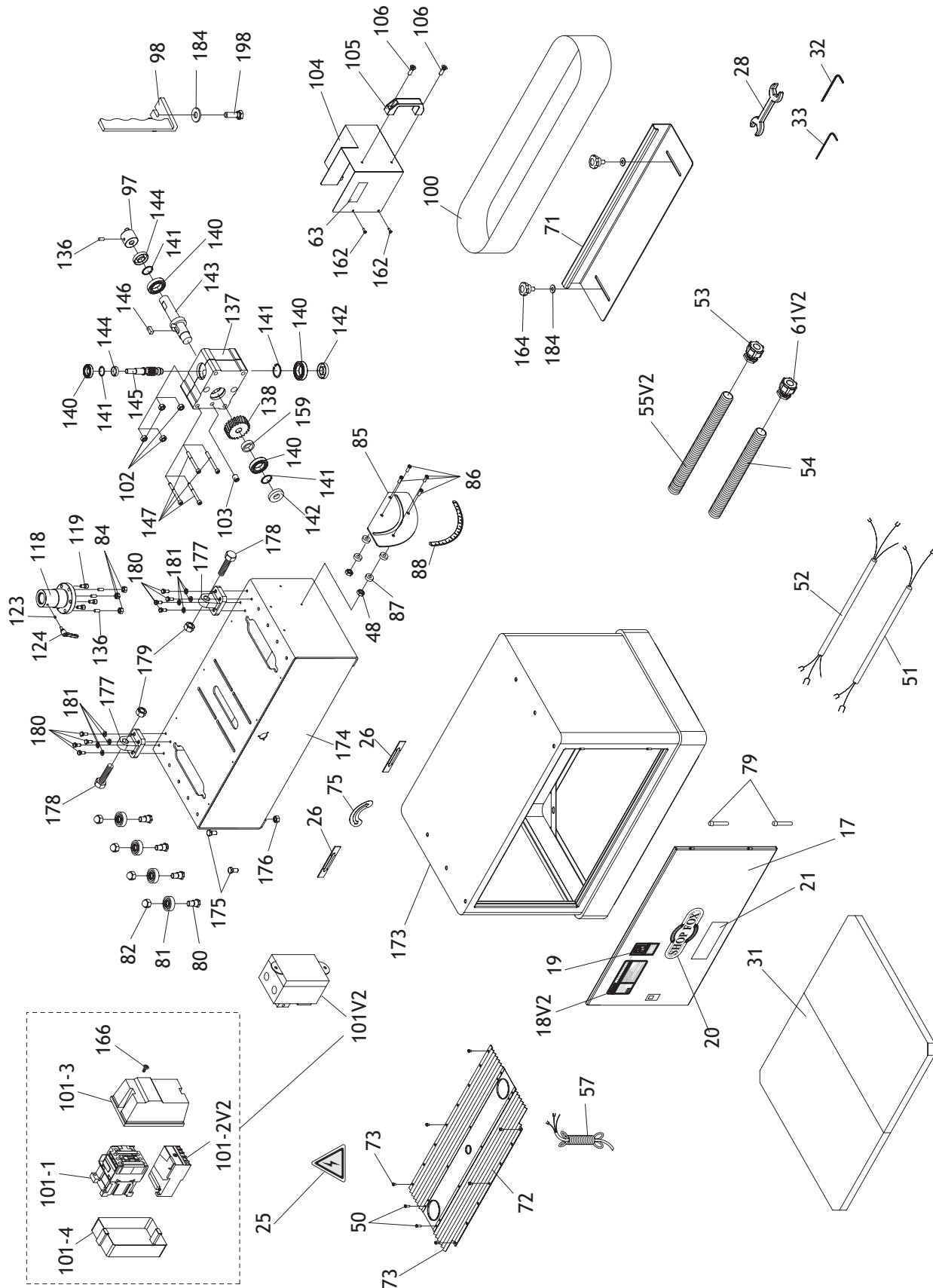

Parts Breakdown

REF	PART #	DESCRIPTION	REF	PART #	DESCRIPTION
1	XPSB24M	CAP SCREW M5-.8 X 16	54	X1730054	PLASTIC CONDUIT 3/8" X 11"
2	X1730002	FEMALE KNOB 1/4-20	55V2	X1730055V2	PLASTIC CONDUIT 3/8" X 12" V2.09.11
3	X1730003	MITER GAUGE BODY	56V2	X1730056V2	PLASTIC CONDUIT 3/8" X 18" V2.09.11
4	X1730004	MITER BAR	57	XPWRCRD220L	POWER CORD
5	X1730005	T-SLOT WASHER	58	X1730058	GUARD
6	XPFH01	FLAT HD SCR 10-24 X 3/8	59	X1730059	COVER/DUST PORT
7	XPS08	PHLP HD SCR 10-24 X 3/4	60	X1730060	GREASE FITTING
8	XPN07	HEX NUT 10-24	61V2	X1730061V2	CONDUIT CONNECTOR 3/8" V2.09.11
9	X1730009	PIVOT PIN	62	X1730062	SANDING DRUM SPINDLE
10	X1730010	STOP SHAFT	63	X1730063	ADJUSTMENT LABEL
11	X1730011	POINTER BODY	64	X1730064	RUBBER DRUM 3"
12	X1730012	POINTER PLATE	65	X1730065	RUBBER DRUM 2"
13	XPS18	PHLP HD SCR 10-24 X 1/4	66	X1730066	RUBBER DRUM 1-1/2"
14	X1730014	STUD 1/4-20 X 1-1/4	67	X1730067	SANDING SLEEVE 3"
15	X1730015	PLASTIC WASHER 1/4	68	X1730068	SANDING SLEEVE 2"
16	XPW06	FLAT WASHER 1/4	69	X1730069	SANDING SLEEVE 1-1/2"
17	X1730017	DOOR W/LATCH	70	XPB57	HEX BOLT 1/4-20 X 1/4
18V2	X1730018V2	MACHINE ID LABEL CSA V2.10.11	71	X1730071	FENCE
19	X1730019	READ MANUAL LABEL	72	X1730072	EXTENDABLE COVER
20	XPLOGO2	SF LOGO 3-3/4 X 8-1/8	73	XPS06	PHLP HD SCR 10-24 X 3/8
21	X1730021	MODEL NUMBER LABEL	74	X1730074	HANDWHEEL
22	X1730022	DISCONNECT LABEL	75	X1730075	ROTATION LABEL
23	X1730023	DUST HAZARD LABEL	76	XPB03	CAP SCREW 5/16-18 X 1
24	X1730024	SAFETY GLASSES LABEL	77	XPSB05	CAP SCREW 1/4-20 X 3/4
25	X1730025	ELECTRICITY LABEL	78	X1730078	TABLE
26	X1730026	TABLE ADJUSTMENT LABEL	79	X1730079	HINGE PIN 8 X 45MM
27	X1730027	ROD	80	X1730080	ECCENTRIC BOLT
28	XPWR1012	WRENCH 10 X 12MM	81	XP6001	BALL BEARING 6001ZZ
29	X1730029	PLATE 70 X 31.7 X 8	82	X1730082	ACORN NUT 3/8-16
30	X1730030	POINTER	83	XPCB06	CARRIAGE BOLT 5/16-18 X 1-1/4
31	X1730031	WOOD BOARD 25 X 395 X 457	84	XPLN03	LOCK NUT 5/16-18
32	XPAW06M	HEX WRENCH 6MM	85	X1730085	SCALE PLATE
33	XPAW05M	HEX WRENCH 5MM	86	XPFH05	FLAT HD SCREW 1/4-20 X 3/4
34	X1730034	TABLE INSERT 4"	87	X1730087	MITER GAUGE SPACER
35	X1730035	TABLE INSERT 3"	88	X1730088	ANGLE GAUGE LABEL
36	X1730036	TABLE INSERT 2-1/2"	89	X1730089	HANDLE 3/8-16 X 50
37	X1730037	TABLE INSERT 1-1/2"	90	XPW02	FLAT WASHER 3/8
38	XPFH01	FLAT HD SCR 10-24 X 3/8	91	X1730091	SPECIAL NUT 3/8-16
39	XPR11M	EXT RETAINING RING 25MM	92	XPN32M	HEX NUT M14-2
40	X1730040	IDLER ROLLER COVER	93	X1730093	TIE ROD
41	X1730041	TABLE MOUNTING BRACKET	94	X1730094	ADJUSTING ROD
42	XPSB01M	CAP SCREW M6-1 X 16	95	XPW06	FLAT WASHER 1/4"
43	XPSS08	SET SCREW 5/16-18 X 1/2	97	X1730097	ECCENTRIC
44	X1730044	HEX SPINDLE FRONT COVER	98	X1730098	BACK STOP
45	X1730045	SLEEVE	99	X1730099	GRAPHITE PAPER
46	X1730046	HEX SPINDLE	100	X1730100	SANDING BELT 6 X 89
47	X1730047	HEX SPINDLE BACK COVER	101V2	X1730101V2	MAGNETIC SWITCH V2.10.11
48	XPN05	HEX NUT 1/4-20	101-1	X1730101-1	CONTACTOR SDE MA-09 220-240V
49	XPSB11	CAP SCREW 5/16-18 X 1-1/4	101-2V2	X1730101-2V2	OL RELAY SDE RA-20 8-12A V2.10.11
50	XPS08	PHLP HD SCR 10-24 X 3/4	101-3	X1730101-3	MAG SWITCH FRONT COVER
51	X1730051	EMERGENCY STOP PWR CORD	101-4	X1730101-4	MAG SWITCH REAR COVER
52	X1730052	MOTOR POWER CORD	102	XPN03M	HEX NUT M8-1.25
53	X1730053	CONDUIT CONNECTOR 3/8"	103	X1730103	SET SCREW NPT 1/8

Parts Breakdown

REF	PART #	DESCRIPTION
104	X1730104	GEAR BOX COVER
105	X1730105	HANDLE
106	XPS12	PHLP HD SCR 1/4-20 X 5/8
107	X1730107	ADJUSTING PLATE
108	X1730108	RACK & PINION BOX
109	XPSB07	CAP SCREW 5/16-18 X 3/4
110	X1730110	COPPER RING
111	X1730111	PINION GEAR
112	X1730112	SPACER
113	X1730113	PINION SPINDLE
114	X1730114	COPPER RING
115	X1730115	PINION ROD
116	X1730116	COVER PLATE
117	X1730117	BALL BEARING 38 X 42 X 20T
118	X1730118	SPINDLE
119	XPSB04	CAP SCREW 1/4-20 X 1/2
120	X1730120	LOCK COLLAR
121	X1730121	HANDLE BAR
122	X1730122	FEMALE KNOB 3/8-16
123	X1730123	COPPER INSERT 5 X 3
124	X1730124	HANDLE 1/4 X 1/2
125	X1730125	RACK GEAR
126	X1730126	SPINDLE
127V2	X1730127V2	MOTOR 2HP 240V 1PH V2.10.11
127-1	X1730127-1	ELCTRICAL BOX
127-2	X1730127-2	CAPACITOR COVER
127-3	XPC400A	S CAPACITOR 400MFD/125V
127-4	X1730127-4	FAN
127-5	X1730127-5	FAN COVER
127-6	X1730127-6	R CAPACITOR 60M 250V 1-3/8 x 3-3/8
128	X1730128	DRIVE ROLLER
129	X1730129	DUST PORT
130	XPLW06	LOCK WASHER 5/8
131	XPNO4	HEX NUT 5/8-11
132	XPB18	HEX BOLT 3/8-16 X 1
133	X1730133	GEAR BOX FIXING PLATE
134	XPB09	HEX BOLT 5/16-18 X 1/2
135	X1730135	SPINDLE CONNECTOR
136	XPSS08	SET SCREW 5/16-18 X 1/2
137	X1730137	GEAR BOX
138	X1730138	WORM GEAR
139	XPSB16	CAP SCREW 3/8-16 X 3/4"
140	XP6202	BALL BEARING 6202Z
141	XPR41M	INT. RETAINING RING 35MM
142	X1730142	OIL SEAL WITHOUT HOLE
143	X1730143	DRIVE SHAFT
144	X1730144	OIL SEAL WITH HOLE
145	X1730145	WORM SHAFT
146	X1730146	KEY 7 X 7 X 16
147	XPSB19M	CAP SCREW M8-1.25 X 75
148	X1730148	IDLER ROLLER BRACKET

REF	PART #	DESCRIPTION
149	X1730149	IDLER ROLLER SPINDLE
150	X1730150	SPECIAL WASHER 5/16
151	XPB09	HEX BOLT 5/16-18 X 1/2
152	XP6205	BALL BEARING 6205Z
153	X1730153	IDLER ROLLER
154	X1730154	KNOB 3/8-16 X 1
155	X1730155	TABLE SPINDLE
156	X1730156	KEY 8 X 8 X 315
157	XPSB17M	CAP SCREW M4-.7 X 10
158	X1730158	U-TYPE CAST IRON TABLE
159	X1730159	ALUMINUM RING
160	XPS09	PHLP HD SCR 1/4-20 X 1/4
161	XP5101	THRUST BALL BEARING 5101
162	XPSB04	CAP SCREW 1/4-20 X 1/2
163	X1730163	PLATEN COVER
164	X1730164	STAR KNOB 5/16-18 X 1
165	X1730165	EMERGENCY STOP SWITCH
166	XPS08	PHLP HD SCR 10-24 X 3/4
167	X1730167	SWITCH COVER
168	XPNO7	HEX NUT 10-24
169	XPB43M	HEX BOLT M12-1.75 X 75
170	XPLN09M	HEX NUT M12-1.75
171	X1730171	MOTOR BRACKET
172	XPSB18	CAP SCREW 1/4-20 X 1-3/4
173	X1730173	BASE
174	X1730174	GEAR CABINET
175	XPB21	HEX BOLT 3/8-16 X 3/4
176	XPNO8	HEX NUT 3/8-16
177	X1730177	SWIVEL BRACKET
178	XPB82	HEX BOLT 3/4-10 X 2-1/4
179	XPLN12M	LOCK NUT 3/4-10
180	XPB09	HEX BOLT 5/16-18 X 1/2
181	XPLW01	LOCK WASHER 5/16"
182	X1730182	PLATEN
183	X1730183	TENSIONING LINK ARM
184	XPW07	FLAT WASHER 5/16
185	XPSB30	CAP SCREW 5/16-18 X 1/2
186	XPNO13	NUT 1/2-13
187	X1730187	HANDLE BAR
188	X1730188	FEMALE KNOB 1/2-13
189	X1730189	SPINDLE BRACKET
190	X1730190	SPINDLE
191	XPSB05	CAP SCREW 1/4-20 X 3/4
192	XPLN02	LOCK NUT 1/4-20
193	X1730193	CONDENSED SPRING
194	XPW14	FLAT WASHER 5/8
195	XPNO4	LOCK NUT 5/8-11
196	XPSB32	CAP SCREW 1/4-20 X 1-1/4
197	X1730197	SHAFT
198	XPSB03	CAP SCREW 5/16-18 X 1
199	X1730199	STRAIN RELIEF

WARRANTY REGISTRATION

Name _____

Street _____

City _____ State _____ Zip _____

Phone Number _____ E-Mail _____ FAX _____

MODEL # _____ SERIAL # _____ DEALER NAME _____ PURCHASE DATE ____/____/____

The following information is given on a voluntary basis and is strictly confidential.

CUT ALONG DOTTED LINE

- | | |
|--|---|
| <p>1. How did you first learn about us?</p> <p> <input type="checkbox"/> Advertisement <input type="checkbox"/> Friend
 <input type="checkbox"/> Mail order Catalog <input type="checkbox"/> Local Store
 <input type="checkbox"/> World Wide Web Site

 <input type="checkbox"/> Other _____ </p> | <p>9. What stationary woodworking tools do you own? Check all that apply.</p> <p> <input type="checkbox"/> Air Compressor <input type="checkbox"/> Panel Saw
 <input type="checkbox"/> Band Saw <input type="checkbox"/> Planer
 <input type="checkbox"/> Drill Press <input type="checkbox"/> Power Feeder
 <input type="checkbox"/> Drum Sander <input type="checkbox"/> Radial Arm Saw
 <input type="checkbox"/> Dust Collector <input type="checkbox"/> Shaper
 <input type="checkbox"/> Horizontal Boring Machine <input type="checkbox"/> Spindle Sander
 <input type="checkbox"/> Jointer <input type="checkbox"/> Table Saw
 <input type="checkbox"/> Lathe <input type="checkbox"/> Vacuum Veneer Press
 <input type="checkbox"/> Mortiser <input type="checkbox"/> Wide Belt Sander
 <input type="checkbox"/> Other _____ </p> |
| <p>2. Which of the following magazines do you subscribe to.</p> <p> <input type="checkbox"/> Cabinetmaker <input type="checkbox"/> WOOD
 <input type="checkbox"/> Family Handyman <input type="checkbox"/> Wooden Boat
 <input type="checkbox"/> Fine Homebuilding <input type="checkbox"/> Woodshop News
 <input type="checkbox"/> Woodsmith <input type="checkbox"/> Today's Homeowner
 <input type="checkbox"/> Home Handyman <input type="checkbox"/> Woodwork
 <input type="checkbox"/> Journal of Light Construction <input type="checkbox"/> Woodworker
 <input type="checkbox"/> Old House Journal <input type="checkbox"/> Woodworker's Journal
 <input type="checkbox"/> Popular Mechanics <input type="checkbox"/> Workbench
 <input type="checkbox"/> Popular Science <input type="checkbox"/> American How-To
 <input type="checkbox"/> Popular Woodworking
 <input type="checkbox"/> Other _____ </p> | <p>10. Which benchtop tools do you own? Check all that apply.</p> <p> <input type="checkbox"/> 1" x 42" Belt Sander <input type="checkbox"/> 6" - 8" Grinder
 <input type="checkbox"/> 5" - 8" Drill Press <input type="checkbox"/> Mini Lathe
 <input type="checkbox"/> 8" Table Saw <input type="checkbox"/> 10" - 12" Thickness Planer
 <input type="checkbox"/> Scroll Saw <input type="checkbox"/> Spindle/Belt Sander
 <input type="checkbox"/> Disc/Belt Sander
 <input type="checkbox"/> Mini Jointer
 <input type="checkbox"/> Other _____ </p> |
| <p>3. Which of the following woodworking/remodeling shows do you watch?</p> <p> <input type="checkbox"/> Backyard America <input type="checkbox"/> The New Yankee Workshop
 <input type="checkbox"/> Home Time <input type="checkbox"/> This Old House
 <input type="checkbox"/> The American Woodworker <input type="checkbox"/> Woodwright's Shop
 <input type="checkbox"/> Other _____ </p> | <p>11. Which portable/hand held power tools do you own? Check all that apply.</p> <p> <input type="checkbox"/> Belt Sander <input type="checkbox"/> Orbital Sander
 <input type="checkbox"/> Biscuit Joiner <input type="checkbox"/> Palm Sander
 <input type="checkbox"/> Circular Saw <input type="checkbox"/> Portable Planer
 <input type="checkbox"/> Detail Sander <input type="checkbox"/> Saber Saw
 <input type="checkbox"/> Drill/Driver <input type="checkbox"/> Reciprocating Saw
 <input type="checkbox"/> Miter Saw <input type="checkbox"/> Router
 <input type="checkbox"/> Other _____ </p> |
| <p>4. What is your annual household income?</p> <p> <input type="checkbox"/> \$20,000-\$29,999 <input type="checkbox"/> \$60,000-\$69,999
 <input type="checkbox"/> \$30,000-\$39,999 <input type="checkbox"/> \$70,000-\$79,999
 <input type="checkbox"/> \$40,000-\$49,999 <input type="checkbox"/> \$80,000-\$89,999
 <input type="checkbox"/> \$50,000-\$59,999 <input type="checkbox"/> \$90,000 + </p> | <p>12. What machines/supplies would you like to see?</p> <p>_____</p> <p>_____</p> <p>_____</p> |
| <p>5. What is your age group?</p> <p> <input type="checkbox"/> 20-29 <input type="checkbox"/> 50-59
 <input type="checkbox"/> 30-39 <input type="checkbox"/> 60-69
 <input type="checkbox"/> 40-49 <input type="checkbox"/> 70 + </p> | <p>13. What new accessories would you like Woodstock International to carry?</p> <p>_____</p> <p>_____</p> |
| <p>6. How long have you been a woodworker?</p> <p> <input type="checkbox"/> 0 - 2 Years <input type="checkbox"/> 8 - 20 Years
 <input type="checkbox"/> 2 - 8 Years <input type="checkbox"/> 20+ Years </p> | <p>14. Do you think your purchase represents good value?</p> <p> <input type="checkbox"/> Yes <input type="checkbox"/> No </p> |
| <p>7. How would you rank your woodworking skills?</p> <p> <input type="checkbox"/> Simple <input type="checkbox"/> Advanced
 <input type="checkbox"/> Intermediate <input type="checkbox"/> Master Craftsman </p> | <p>15. Would you recommend SHOP FOX® products to a friend?</p> <p> <input type="checkbox"/> Yes <input type="checkbox"/> No </p> |
| <p>8. How many SHOP FOX® machines do you own? _____</p> | <p>16. Comments: _____</p> <p>_____</p> <p>_____</p> <p>_____</p> |

FOLD ALONG DOTTED LINE

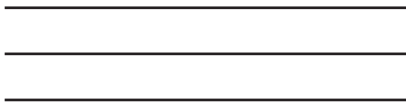

Place
Stamp
Here



WOODSTOCK INTERNATIONAL INC.
P.O. BOX 2309
BELLINGHAM, WA 98227-2309



FOLD ALONG DOTTED LINE

TAPE ALONG EDGES--PLEASE DO NOT STAPLE

WARRANTY

Woodstock International, Inc. warrants all SHOP FOX® machinery to be free of defects from workmanship and materials for a period of 2 years from the date of original purchase by the original owner. This warranty does not apply to defects due directly or indirectly to misuse, abuse, negligence or accidents, lack of maintenance, or to repairs or alterations made or specifically authorized by anyone other than Woodstock International, Inc.

Woodstock International, Inc. will repair or replace, at its expense and at its option, the SHOP FOX® machine or machine part which in normal use has proven to be defective, provided that the original owner returns the product prepaid to the SHOP FOX® factory service center or authorized repair facility designated by our Bellingham, WA office, with proof of their purchase of the product within 2 years, and provides Woodstock International, Inc. reasonable opportunity to verify the alleged defect through inspection. If it is determined there is no defect, or that the defect resulted from causes not within the scope of Woodstock International Inc.'s warranty, then the original owner must bear the cost of storing and returning the product.

This is Woodstock International, Inc.'s sole written warranty and any and all warranties that may be implied by law, including any merchantability or fitness, for any particular purpose, are hereby limited to the duration of this written warranty. We do not warrant that SHOP FOX® machinery complies with the provisions of any law or acts. In no event shall Woodstock International, Inc.'s liability under this warranty exceed the purchase price paid for the product, and any legal actions brought against Woodstock International, Inc. shall be tried in the State of Washington, County of Whatcom. We shall in no event be liable for death, injuries to persons or property or for incidental, contingent, special or consequential damages arising from the use of our products.

Every effort has been made to ensure that all SHOP FOX® machinery meets high quality and durability standards. We reserve the right to change specifications at any time because of our commitment to continuously improve the quality of our products.



High Quality Machines and Tools

Woodstock International, Inc. carries thousands of products designed to meet the needs of today's woodworkers and metalworkers.

Ask your dealer about these fine products:

BROSENA
PRECISION STOP BLOCK

JOINTER PAL[®]

Rotacator[®]

THE REBEL[®]

DURASTICK[®]

Gutmann[®]

BOARD BUDDIES[®]



Junglee[®]

PLANER PAL[®]

PARROT VISE[®]

SLICKPLANE[®]

PRO-STIK[®]
ABRASIVE BELT & DISC CLEANER

ACCU-SHARP[®]

Aluma-Classic[®]



STEELEX[®]
FINE TOOLS

STEELEX[®]
PLUS



WHOLESALE ONLY

WOODSTOCK INTERNATIONAL, INC.

Phone: (360) 734-3482 • Fax: (360) 671-3053 • Toll Free Fax: (800) 647-8801

P.O.Box 2309 • Bellingham, WA 98227

SHOPFOX.BIZ