

LAGUNA

Panel saw P12|10
MPSP12-10-0135



LAGUNA TOOLS

17101 Murphy Ave.
Irvine, California 92614
Ph: 800.234.1976
www.lagunatools.com

Part No. MPSP12-10-0135

© 2013 Laguna Tools, Inc. All rights reserved.

Table of Contents

1. INFORMATION	
1-1. General information.....	P1
1-2. Safety rules	P2
2. MACHINE INFORMATION	
2-1. Main Feature.....	P6
2-2. Specification.....	P7
3. INSTALLATION	
3-1. Unpacking.....	P8
3-2. Check machine accessories.....	P10
3-3. Fitting sliding table.....	P11
3-4. Fitting crosscut frame & crosscut fence.....	P12
3-5. Fitting the extension table	P14
3-6. Overhead saw blade guard and control panel fitting.....	P15
3-7. Fitting rip fence.....	P18
3-8. Fitting the saw blade.....	P19
3-9. Riving knife.....	P20
3-10. Changing scoring blade.....	P21
3-11. Edge shoe & hold down.....	P23
3-12. Connection to the dust collection	P24
3-13. Wiring & test run	P25
4. OPERATION	
4-1. Saw blade lifting and tilting.....	P26
4-2. Scoring blade adjusting	P27
4-3. Control panel operation	P29
4-4. Speed change.....	P30
4-5. Setting the fence for parallel cuts.....	P31
4-6. Sliding table.....	P34
4-7. Setting the rest rule.....	P35
5. MAINTENANCE	
5-1. Machine cleaning & check.....	P38
5-2. Periodical lubrication	P40
5-3. Replacing belt.....	P41
6. TOOLS LIST.....	P43
7. TROUBLESHOOTING.....	P44
8. WIRING DIAGRAM	

Table of Contents

9. PARTS LIST

- ASSEM01- Machine body & table
- ASSEM02- Control panel
- ASSEM03- Power unit
- ASSEM04- Saw blade angle device
- ASSEM05- Saw blade rise & fall device
- ASSEM06- Scoring device
- ASSEM07- Outrigger arm
- ASSEM08- Crosscut table
- ASSEM09- Crosscut fence
- ASSEM10- Rip fence
- ASSEM11- Sliding table
- ASSEM12- Saw blade guard device
- ASSEM13- Angle encode
- ASSEM14- Accessories

1. INFORMATION

1-1 General Information

Laguna Tools, Inc. is specialized to supply full range of panel saw from 1600, 2300, 2500, 3200 to 3800mm. The outlook design of this machine is so unique with complete cast iron bracket instead of sheet metal, enlarged outrigger and carriage, direct dust collection outlet.

Besides of our Band Saw series, these Table Saw series are also innovative products. Please enjoy your operation on this machine and if you have any comment to improve them, please don't hesitate to contact us through your agent.

As woodworking machines with the quality design, our Panel Saw series are designed to well rip solid wood, chipboard, fiberboard, plywood and similar materials. During the usage, be careful of rigidity of working materials and don't try forbidden materials such as low flash point metals and high stiff stone, etc. HSS (High Speed Steel) saw blade and milling tools should not be used.

The saw blade made in accordance with EN847-1: 1997 shall be used on the machine. Generally speaking, this machine will be installed as the following conditions:

- 1) Supply voltage: 0.9 - 1.1 normal supply voltage
- 2) Source frequency: 0.99 - 1.01 normal frequency
- 3) Ambient temperature: 5°C - 40°C.
- 4) Altitude: shall be at altitudes up to 1000m above the middle sea level.
- 5) Relative humidity: not exceed 50% at 40°C.
- 6) Atmosphere: Free from excessive dust, acid fume, corrosive gases and salt.
- 7) Avoid exposing to direct sunlight or heat rays which can change the environmental temp.
- 8) Avoid exposing to abnormal vibration.
- 9) Electrical equipment shall withstand the effects of transportation and storage temperature within a range of -25°C to 55°C. Then, for short periods, it does not exceed 24 hours at up to +70°C.

This machine was designed for certain applications only. We strongly recommend that this machine NOT be modified and/or used for any application which for other than its design.

If you have any question, which is relative to its application, DO NOT use the machine until you have had detail instruction from your dealer.

1. INFORMATION

1-2. Safety Rules

- 1) **Read instruction manual before operating the machine for your safety.**

People who operate the machine must be trained, read and understood to use the safety measures, possess the ability to obey, and execute the regulation stated in this manual. Learn the machine's application and limitations as well as the specific hazards peculiar to it.

- 2) **Ground all machines.**

It should make sure the "PE" terminal being connection before machine operating.

- 3) **Keep guards in place and working area clean.**

Keep guards in place and in working order.

- 4) **Don't use in dangerous environment.**

Don't use machines in damp or wet locations, or expose them to rain.

Please provide a suitable illumination around the machine for safety operation.

- 5) **Keep children and visitors away.**

All children and visitors should be kept in a safe distance from working area.

- 6) **Store idle tools (cutting spindle).**

When not in usage, tools should be stored in a dry, high or locked up place, out of reach for children.

- 7) **Wear proper apparel.**

No loose clothing, glove, neckties, rings, bracelets, or other jewelry which may be gotten caught in moving parts. Wear protective hair covering to contain long hair.

Please wear glove to take/ replace saw blade and wear eye-shield/ ear-shield to operation.

- 8) **Stay alert.**

Watch what you are doing. Do not operate machine when you are tired.

- 9) **Don't force machines.**

It will do the job better and be safer at the rate for which it was designed.

- 10) **SHUT OFF** the power.

Remove the products and isolated energy before leaving the machine. Shut off the power and carried out only when the machine is stationary before inspection, maintenance, adjustment and cleaning.

- 11) **No smoking!!** Don't smoking while operate machine.

1. INFORMATION

- 12) Have your machine repaired by a qualified person.
Repairs should be carried out by qualified-persons using original spare parts; otherwise this may result in considerable danger to the user.
- 13) Check any damaged parts.
Before using the machine further, the guard or other damaged part should first be carefully checked to determine if it will operate properly and perform its intended function. Check the alignment of moving parts, binding of moving parts, breakage of parts, mounting, and any other conditions that may affect its operation. A guard or other part that is damaged should be properly repaired or replaced.
- 14) Disposing of wasted material
Disposing wasted material and wasted lubricating oil shall obey the local regulation and be deeply careful.
- 15) Fire extinguisher:
Workshop of user shall be with the fire extinguisher or other devices according to the local safety regulations and be deeply careful.
- 16) Stand on proper position for operation.
Please stand in front of machine for operation.
- 17) Use recommended ancillary equipment.
Consult of the instruction manual of drawing for recommended accessories. The use of improper accessories may cause risk of injury to persons. If ancillary equipment is removed the original guards or safety devices shall be replaced.
Laguna Tools and our authorized agency are responsible for a the machine with ancillary equipment only if we ourselves have designed such connection.
- 18) Reduce the risk of unintentional starting.
Make sure switches of control panel are OFF position before operating.
- 19) Never leave machine running unattended. Turn power off from the hand-held disconnecting device. Don't leave machine until it comes to a complete stop.
- 20) Make sure machine is disconnected from power supply.
Make sure machine is disconnected from power supply before started the normal maintenance and service, adjustment, or repairing.
- 21) Reaction with emergency situation.
This machine provides two emergency buttons. One is self-latching push-button on the control panel of access position. Other emergency

1. INFORMATION

buttons are position on the front side on the machine near in-feed working area. The emergency button is colored red and yellow background. After emergency stop, follow the normal start up procedure and suitable operation to obviate the hazard. Please see the afterward pages of emergency stop position diagram.

- 22) Never open the protective cover or the machine door while the machine is running.
- 23) When the machine is out of order while running, shut it down and to call servicemen for help as soon as possible.
- 24) Wear ear protectors (plugs or muffs) during extended periods of operation.
- 25) Remove adjusting keys and wrenches before turning machine on. Be sure that the keys and adjusting wrenches have been removed and all the nuts and bolts are secured.
- 26) After switching off the saw motor, allow the saw blade to stop freely. Never attempt to stop the cutting by hand or other objects.
- 27) Never cut the wood plate if there is no completed width or too small.
- 28) The max. Rotation speed marked on the saw blade must not be exceeded.
- 29) The machine shall be not loaded with more than work piece at a time.
- 30) During making wooden cases, it will emit harmful dust. User must install exhaust system for the extraction of harmful dust.
- 31) Use correctly sharpened saw blades. Observe the max. Speed marked on the saw blade. User shall be to select the optimum speed for saw blade.
- 32) Report faults on the machine, including guards or saw blades, as soon as they are discovered.
- 33) Adopt safe procedures for cleaning, maintenance and remove chips and dust regularly to avoid the risk of fire.
- 34) Follow manufacturer's instructions for operating, adjustment and repair of saw blades.
- 35) Ensure that any spacers and spindle rings used are suitable for the purpose as stated by the manufacturer.
- 36) Refrain from removing any off-cut or other part of the work piece from the cutting area whilst the machine is running.
- 37) Ensure that guards and other safety devices necessary for machine operation are in position, in good working order and properly maintained.
- 38) **Safety working practice.**
 - a) Use of push block and push stick- Push stick should be used to avoid working with hands close to the saw blade. Push blocks should be between 300mm and 400mm long, 80mm to 100mm wide and 15mm to

1. INFORMATION

20mm deep. Push blocks should be used when cutting small work pieces and in circumstances where it is necessary to push the work piece against the fence.

- b) Selection of saw blade and riving knife- the operator should only select saw blade with suitable diameter and thickness for the machine.
- c) Selection of riving knife slot- The riving knife guiding slot should be no more than 0.5mm wider than the riving knife guiding elements.
- d) Fixing of saw blade to spindle- Where the spindle diameter is less than the saw blade bore diameter, flanged bushes provided by the machine manufacture should be used to make up the difference. The use of loose rings or bushes is not permitted.
- e) Lighting- it is important to provide adequate lighting around the machine.

39) Guide the work piece along the rip fence and through the rotation saw blade, using the push stick if necessary. Any damage, please replace new one that specification according below drawing.

40) Do not operate this machine while tired or under the influence of drugs, alcohol or any medication.

41) **The dust generated by certain woods products can be injurious to your health.**

Always operate machinery in well-ventilated areas, and provide for proper dust removal. Use wood dust collection systems whenever possible

42) Any other maintenance is welcome to be contacted manufacturer or our distributor.

2. MACHINE INFORMATION

2-1. MAIN FEATURE



- A. Machine Body
- B. Sliding Table
- C. Edge Shoe
- D. Control Panel
- E. Overhead Guard
- F. Crosscut Fence
- G. Flip Stops
- H. Crosscut Frame
- I. Hold Down With Miter Fence (Optional)

2. MACHINE INFORMATION

2-2. SPECIFICATIONS

ITEM	MODEL
Sliding table dimension	3200x378mm
Cast Iron table	548x896mm
Extension table (rear)	952x896mm
Extension table (front)	830X320mm
Table size	1500x1726mm
Round rail	Φ40mm
Main saw blade (Max.)	400mm
Main saw bore	φ30mm
Max. cutting height at 90 (400mm)	130mm
Max. cutting height at 45 (400mm)	90mm
Main motor power (1ph)	5 HP (3.75 KW)
Main blade speed	3000/4000/5000rpm
Scoring saw blade	φ 120mm
Scoring saw blade bore	φ20mm
Scoring blade motor power	1 HP (0.75kw)
Scoring blade speed	8000 rpm
Cutting width	1300mm
Cutting width adjustment	Manual
Main saw blade tilting adjustment	Manual(0° ~ 45°)
Main saw height adjustment	Manual
Scoring saw adjustment	Manual
Saw guard	Simple (overhead guard as option)
Dust collection system (For overhead guard)	120/63mm (120/102mm)
N.W./G.W./MEAS.: (Machine)	516/618kgs (2110x1200x1110mm)
N.W./G.W./MEAS.: (sliding table)	115/150kgs (3390x490x370mm)
N.W./G.W./MEAS.: (overhead guard)	28.5/32 kgs
Ctn QTY (with overhead guard)	7/17sets

Due to needs of continuous improvement, specification is subject to change without prior notice

3. INSTALLATION

3-1. UNPACKING

SETUP SAFETY

- By offering the comprehensive information regarding to the operation and maintenance of the machine, it will be ensured that operators will use the machine properly.
- Our sales organization is always willing to provide solutions for every technical problem (reparation, spare part delivery), and to help your business with our professional knowledge.
- Keep this handbook for future information, besides, it shall always be kept with the machine. Follow the instruction of this handbook is very important.
- Provide adequate space for working area. It also has to be cleaned and free of scrap material, oil and grease.
- This Model is a heavy-duty machine. The sliding table for the machine weighs is over 115kgs. **Use at least four strong people to lift it in position.** Improper lifting techniques or inadequate lifting assistance could result in serious crushing or strain injuries.
- Place a level on the saw table and adjusting 4 screws when necessary, so the saw table is level from left to right and from front to back.

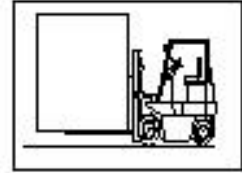

3. INSTALLATION

⚠ IMPORTANT!! Follow the below steps before operating.

1. Before operating, lift up the scoring motor to remove the fixing wood block from the machine. (Figure 3-1.1)
2. Put on the flat belt to the scoring shaft. Be aware of the movement direction mark on the belt. (Figure 3-1.2) Follow the mark to set the belt.
3. Turn the wheel (see A of Fig.3-8.1) to make the whole motor unit 45° tilted. (Figure 3-1.3)
4. Loosen motor plate knob (see arrow). (Figure 3-1.4)
5. Check if the belts are on the correct position to avoid rotational speed problem. For example, if it's set 4000rpm, 2 sides of the belt have to be set on the 4000rpm groove (Figure 3-1.5)
6. Rotate the handle to right hand side to tight the belts then lock the knob to finish. (Figure 3-1.6)



Figure 3-1.1



Figure 3-1.2



Figure 3-1.3

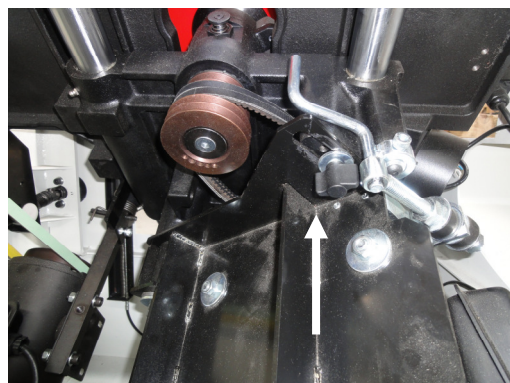

Figure 3-1.4

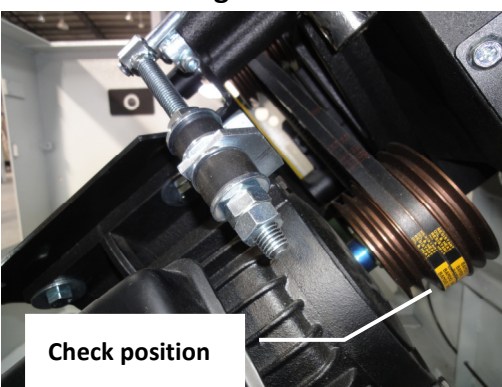

Figure 3-1.5



Figure 3-1.6

3. INSTALLATION

3-2. CHECKS THE MACHINE ACCESSORIES

Packing List

1. Saw base Unit x 1 wooden
2. Sliding Table Unit x 1
3. Assembly parts for crosscut fence x1
4. Assembly parts for crosscut frame. x1
5. Assembly parts for rip fence. x3
6. Assembly parts for dust collection. x1
7. Assembly parts for tool box + sticker + flip stop x 1.
8. Assembly parts for rear extension table. x1
9. Assembly parts for left extension table. x1
10. Assembly parts for edge shoe x1
11. Assembly parts for control panel x1

Optional parts

- ✧ Assembly parts for miter fence x1
- ✧ Assembly parts for overhead saw blade guard D type x5



3. INSTALLATION

3-3.FITTING THE SLIDING TABLE

The accessories bag contains hex head bolts for fixing the sliding table

**For packing and transport reasons, some machine members are removed.
All fitting operations in this section require approx. 4 people**

Note: The parallelism has been adjusted before shipping, users only need to assemble by following the steps below. Then the position of sliding table will be correct.

1. Put the sliding table on the machine frame
2. Position the fix blocks on 2 sides set points as Fig. 3-3.1a
3. Lock the screws (2 sets on each side) on 2 sides to fix the sliding table on the machine frame. (Fig. 3-3.1b)
4. Lock the middle fix block of sliding table on the machine frame. (Fig. 3-3.1c)
5. To assemble for the handle of sliding table, fit the screws in as Fig. 3-3.2 shows.

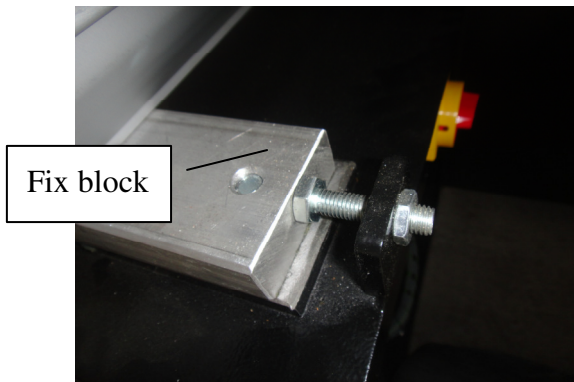

Figure 3-3.1a

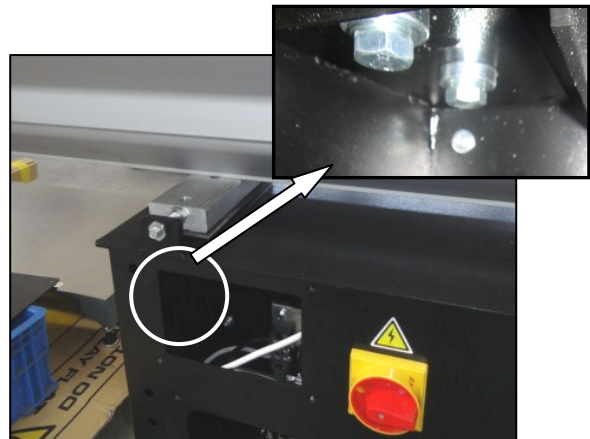

Figure 3-3.1b



Figure 3-3.1c



Figure 3-3.2

3. INSTALLATION

3-4. FITTING THE CROSSCUT FRAME & EXTENSION FENCE ASSEMBLY

All fitting operations in this section require approx. 2 people

I. Fitting the crosscut frame

1. Fit the crosscut frame by putting **A** (Fig. 3-4.1) into the end of swing arm **B**(Fig. 3-4.1). At the same time, fit frame **C** (Fig. 3-4.1) by insert fix plate **F** (Fig.3-3.1c) of the crosscut frame to groove **D** (Fig. 3-4.1) of the sliding table.

Note: the fix plate F has to be placed as Fig. 3-4.1c

2. Make sure **A** (Fig. 3-4.1) is placed properly in the swing arm **B** (Fig. 3-4.1).
3. Tighten lever **E**(Fig. 3-4.1)

※ Notice: To move or take off the crosscut frame, withdraw lever **E**(Fig. 3-4.1)

II. Fitting the crosscut fence

1. Fit the T-nut **R** (Fig. 3-4.1a) into crosscut frame holes **G** (Fig. 3-4.1) then slide the square support pipe in (see arrow of Fig. 3-4.1b).
2. Fit square pipe **I** (Fig. 3-4.2) to **R** (Fig. 3-4.1a) of crosscut frame. And tighten knob **J**(Fig. 3-4.1b & 3-4.2) for fixing on crosscut frame.

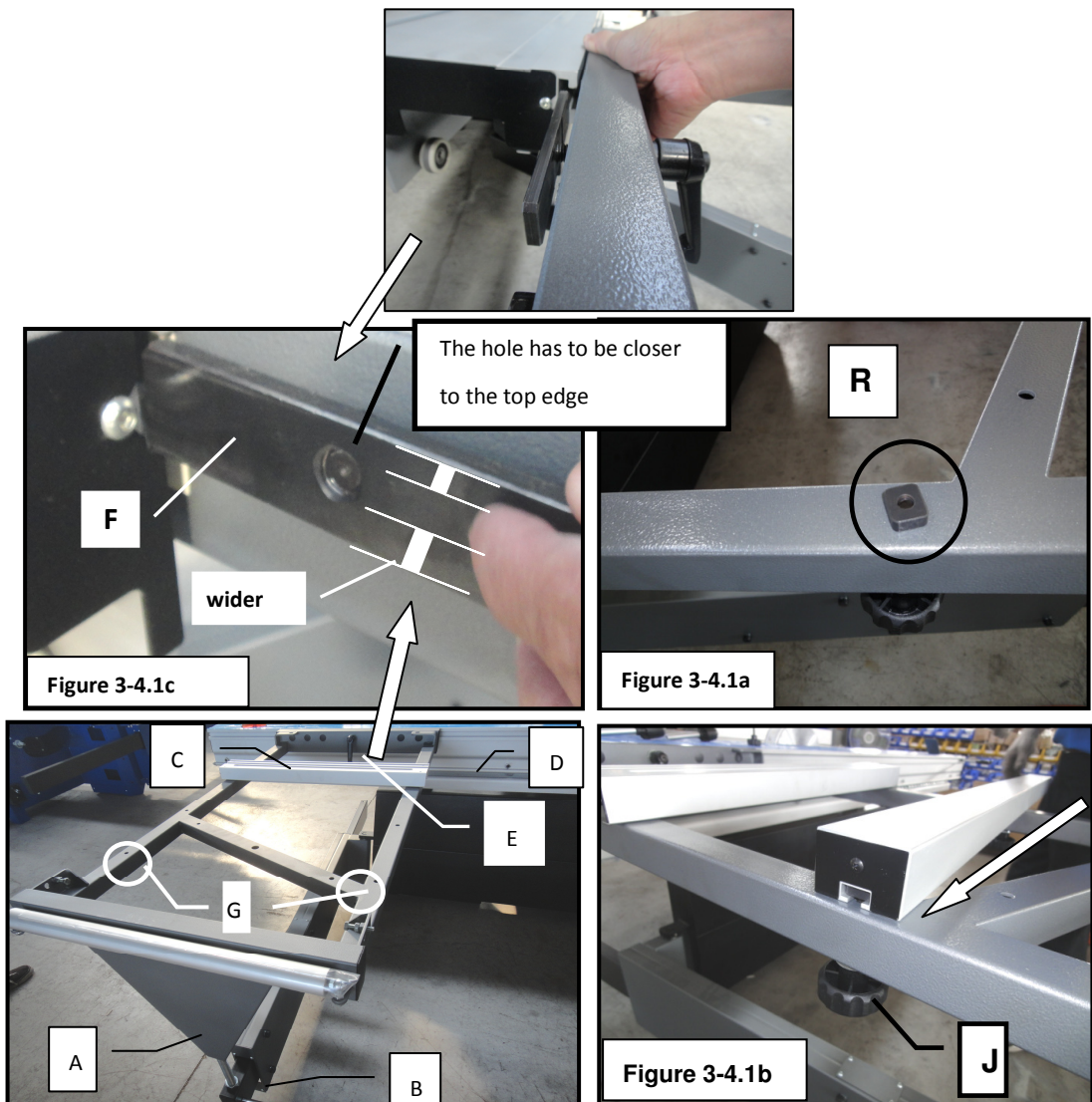

Figure 3-4.1

3. INSTALLATION

- Slide the 4 sets of square pads by follow the arrow direction into the groove at the bottom and lock 1 pad at the end (Fig. 3-4.2a)
 - Fit crosscut fence in the groove **H** (Fig. 3-4.2) and holes on crosscut frame (as Fig 3-4.2b)
 - Lock knob **Y&Z**(Fig. 3-4.c)for fixing
 - Turn nut **L** (Fig.3-4.3a) to make crosscut fence and sliding table exactly vertical. Then lock knob **M** (Fig.3-4.3a) for fixing.
- ※ Notice: Please tie the knob **Z** (Fig.3-4.2a) to fix the fence. And adjust **L** (Fig. 3-4.3a) & **M** (Fig. 3-4.3a) to make ext. fence be exactly vertical with sliding table.

III. Fitting the flip stop units

- Unlocking knob **N**(Fig. 3-4.3) of the extension piece.
- Slide the flip stop unit into groove **O** (Fig. 3-4.3). Then tight **P** (Fig. 3-4.3) to fix.

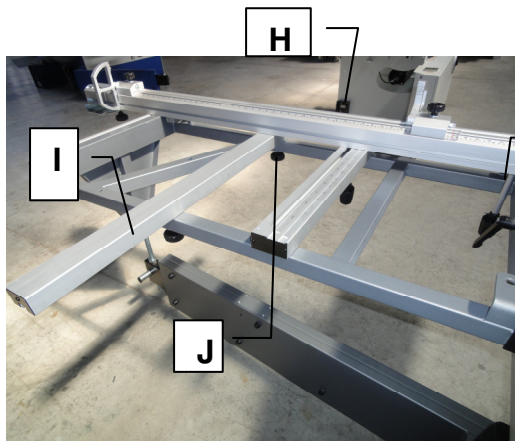

Figure 3-4.2

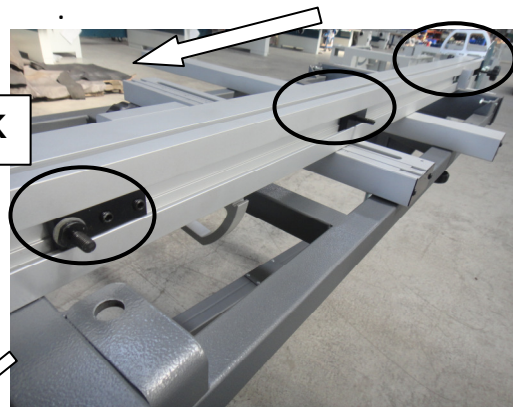

Figure3-4.

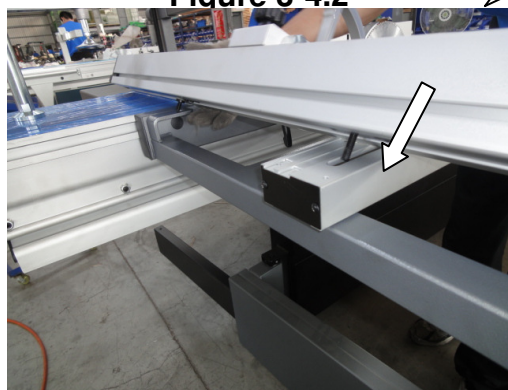

Figure 3-4.2b

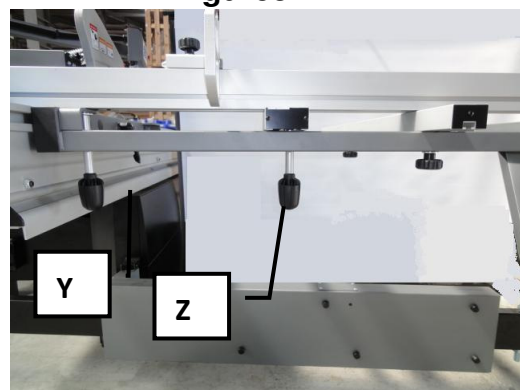

Figure 3-4.2c

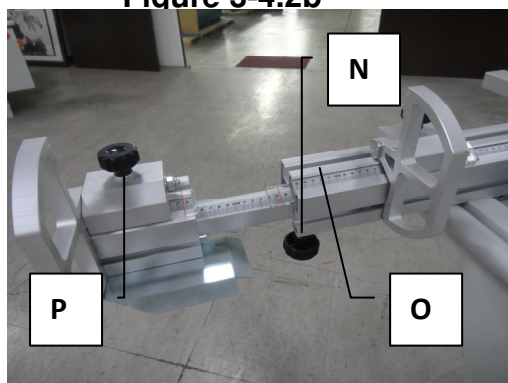

Figure 3-4.3

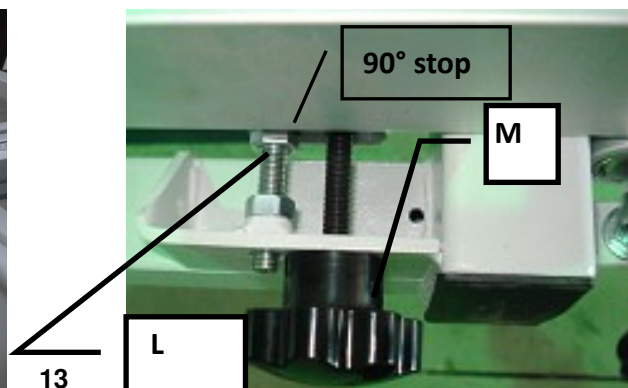

Figure 3-4.3a

3. INSTALLATION

3-5. FITTING THE EXTENSION TABLE

All fitting operations in this section require approx. 2 people

1. Fasten the extension table and keep it aligned with cast iron table. Check the flatness by placing fence plate (F, Figure 3-7.1) on the tables as Fig 3-5.1. The extension table must be even height to cast iron table. However, if the extension table is **lower**, the distance must be less than 0.2mm for smooth operation.
2. If it is not aligned, screw down the three screw **A**(Fig. 3-5.2)
3. Then adjust the alignment with screws **B**(Fig. 3-5.2)

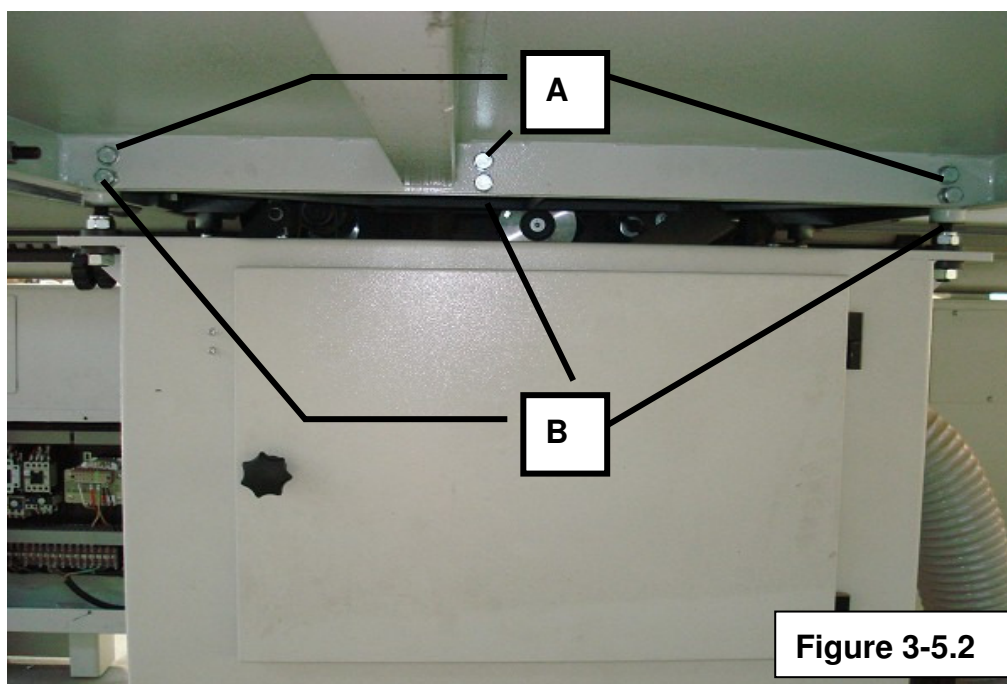
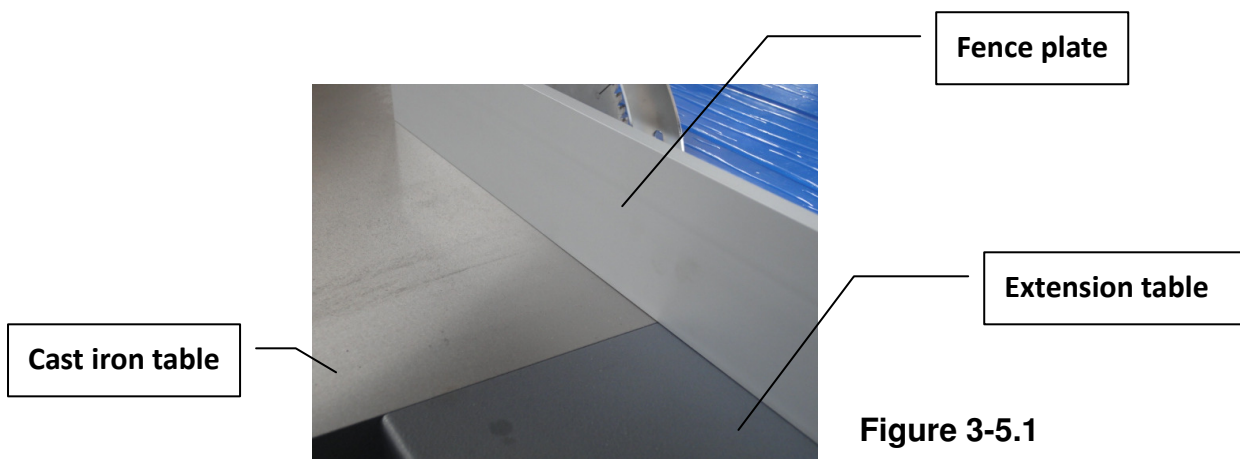

3. INSTALLATION

3-6. OVERHEAD SAW BLADE GUARD AND CONTROL PANEL FITTING

Overhead saw blade guard fits to saw blade with max dia. of more than 355mm.

All fitting operations in this section require approx. 3 people

Following is the instruction of assembly.

Note: Figure 3-6.10 shows the overall assembly points

1. Screw nut in the machine frame **A&B**(Fig. 3-6.1) of the support arm for overhead guard and control panel.
2. Screw nuts **C & D** (Fig. 3-6.2&3) to connect the two parts for support arm
3. Lock lever **E** (Fig. 3-6.4) for support arm of overhead guard
4. Lock the round tube to the support arm as **F** (Fig. 3-6.5)
5. Fit the hose supports on the support arm to fix the hose as **G** (Fig. 3-6.6)
6. Screw **H**(Fig. 3-6.7) for fixing saw blade guard and fix the gas spring **I** (Fig. 3-6.8)
7. Fix the hose on the blade guard and support arm by using hose clamp(Fig. 3-6.9)
8. Fix the cable as shown (Fig. 3-6.10) and control panel with 4 screws (**K**, Fig. 3-6.10).

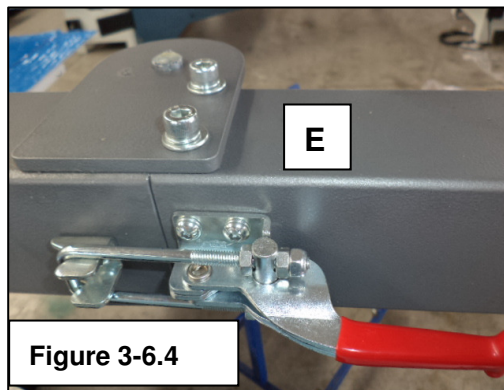
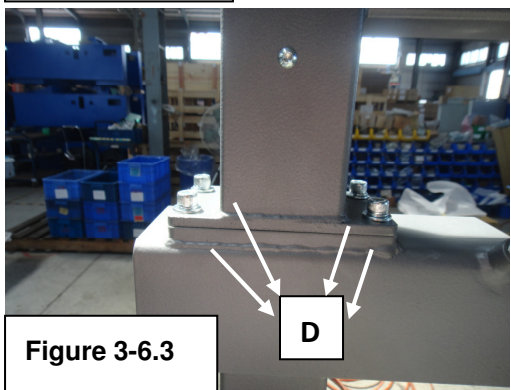
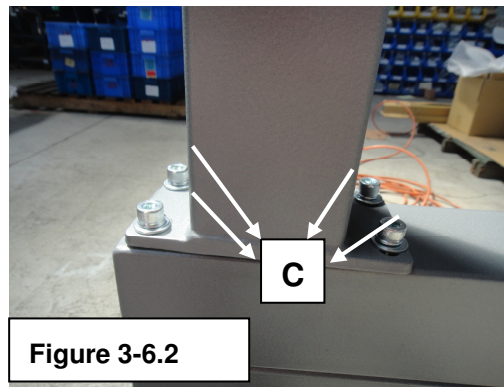
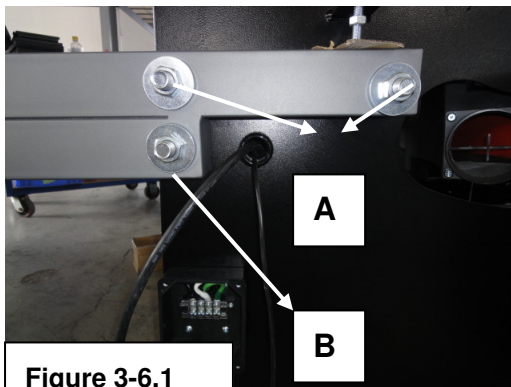

3. INSTALLATION

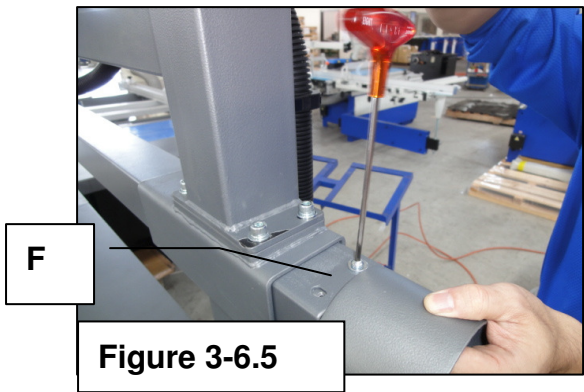

Figure 3-6.5

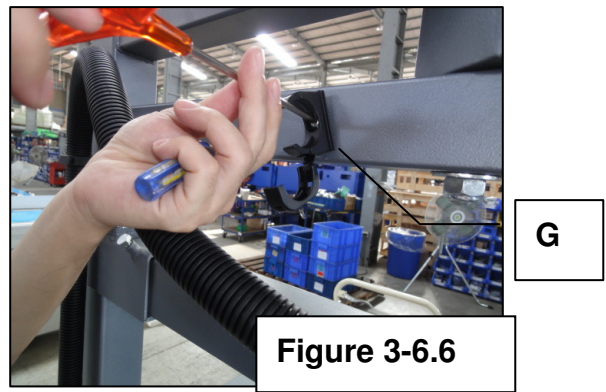

Figure 3-6.6

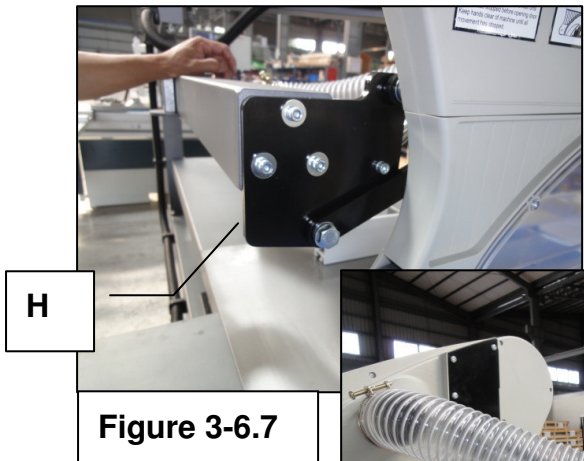

Figure 3-6.7

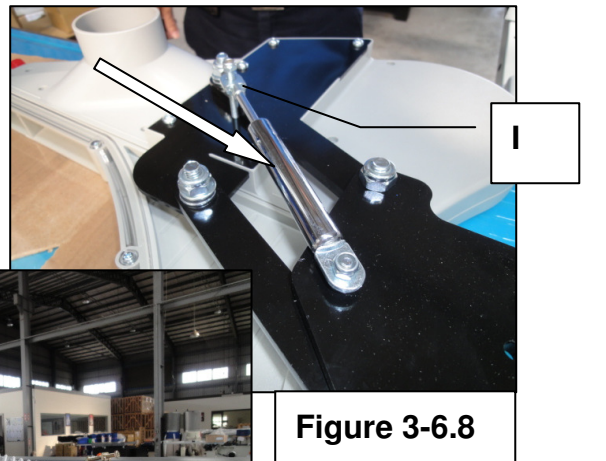

Figure 3-6.8

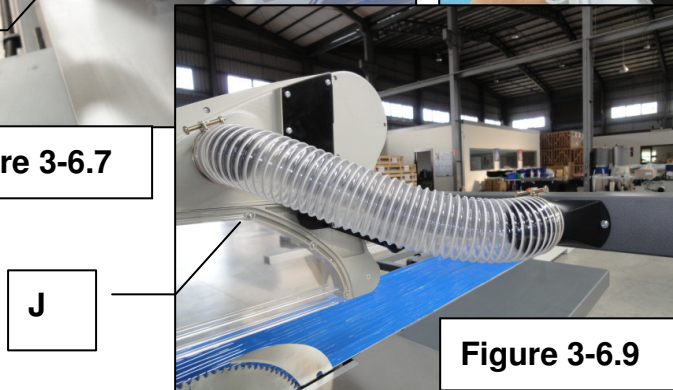

Figure 3-6.9

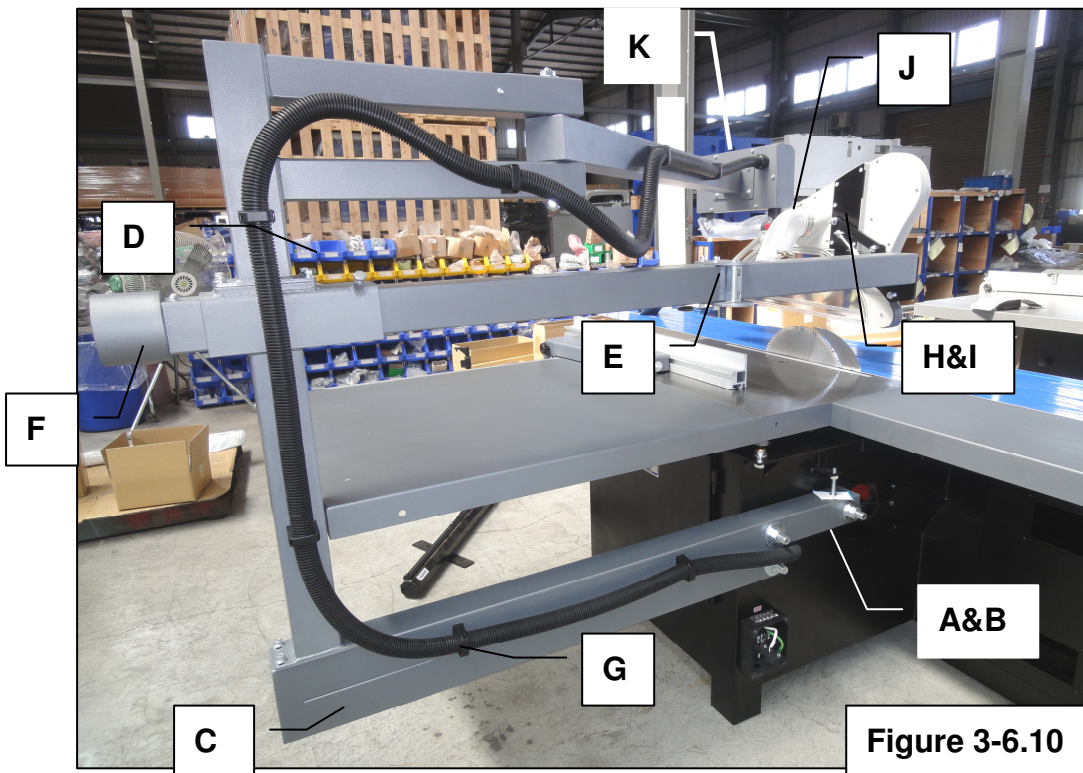

Figure 3-6.10

3. INSTALLATION

3-7. FITTING RIP FENCE

All fitting operations in this section require approx. 2 people

Remove the washer and nut from the round bar first and then

1. Insert the screw rods **H** (Fig. 3-7.1a) of the round bar into the position **A** (Fig. 3-7.1) of working table and extension table then put the washers and nut at the back side of the table, then fasten them in (there are 4 points for fixing the round bar in this position).
2. Mount the fence scale (ruler) set to the edge of the working table and extension table by fastening the fence scale (ruler) set with washer and lock washer
3. Slide rip fence support **C**(Fig. 3-7.1)into round bar **D**(Fig. 3-7.1)
Note: Move handle **E** (Fig. 3-7.1) up to release rip fence, down to lock the rip fence.
4. Mounting fence plate **F** (Fig. 3-7.1) to clamping assembly in upward position and tighten handle **G**.

Notice: Before operation, the 0 mark on the rip fence scale must be aligned with the right side of the blade to ensure the processing accurate.

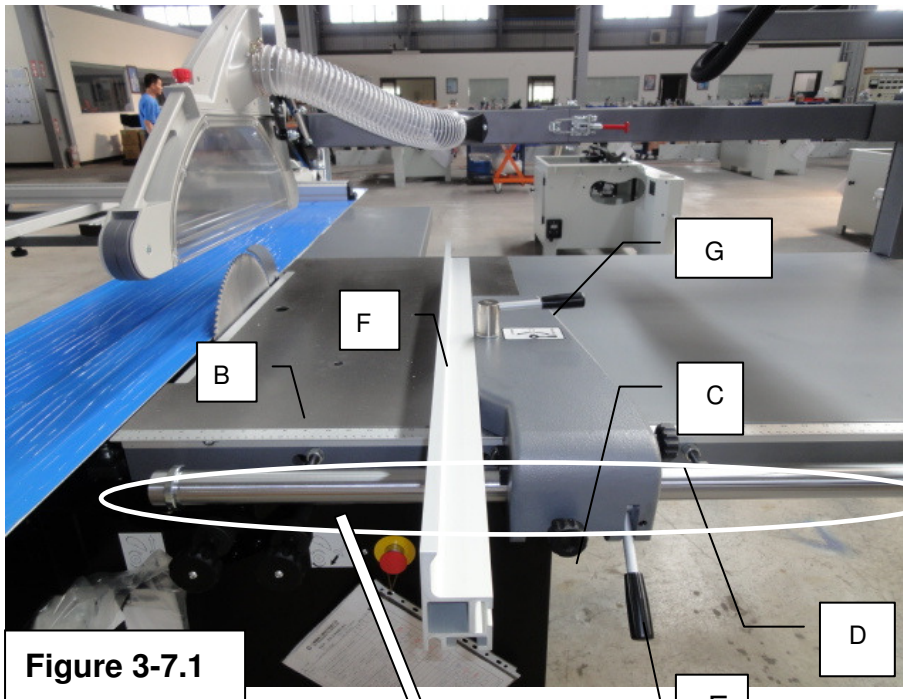

Figure 3-7.1

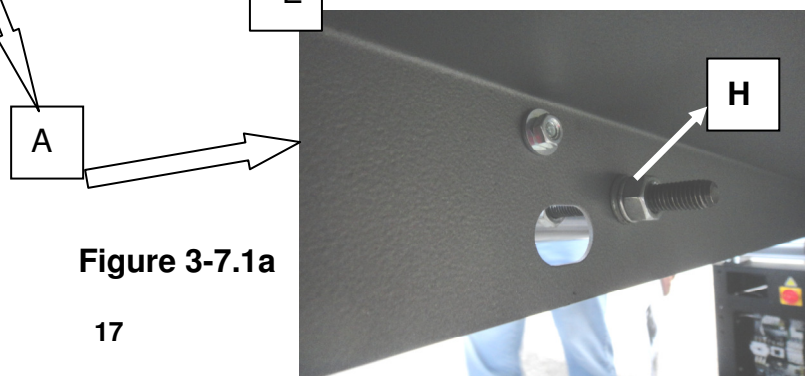

Figure 3-7.1a

3. INSTALLATION

3-8. FITTING THE SAW BLADE

⚠ CAUTION

1. Handle the saw blade with gloves.
2. Open blade protect guard before install the saw blade

Procedure for fitting or replacing the saw blade is as follows:

1. Set the saw unit in 0 degree by turning hand wheel **A** (Fig.3-8.1). , and lock knob.
2. Rise up the main saw blade by turning knob **B** (Fig. 3-8.1) clockwise
3. Press the **emergency button**
4. Move the sliding table totally to the left and push the handle **J** (Fig. 3-8.2c) to the 2nd stop before reach the 1st stop.
5. Open the blade protect guard -red cover **C** (Fig. 3-8.2) by pulling **D** (Fig. 3-8.2a) on both sides of it.
6. Press the button in hole **E** (Fig. 3-8.2b) with thumb for locking the spindle, at the same time, use wrench to loose the screws **F** & washer **I** (Fig. 3-8.2b), remove flange **G** (Fig.3-8.2b) then remove the **red plate** (Fig. 3-8.2b)

Note1: Continually press the button until the screw is loosen.

Note2: Before fitting the saw blade, make sure that the flange **G** (Fig.3-8.2b) is clean to avoid vibrations when the saw blade is rotating

7. Fit the saw blade and flange **G** (Fig.3-8.2b) then press button in **hole E** (Fig. 3-8.3a) with thumb for locking the spindle, at the same time, tight washer **I** & screw **J** (Fig. 3-8.3) to fix the saw blade.

※ Notice:

- ✓ During the operation, pay attention on the saw unit.
- ✓ Pay attention when the blade guard is open, always close it and make sure no one around before you move your sliding table back.

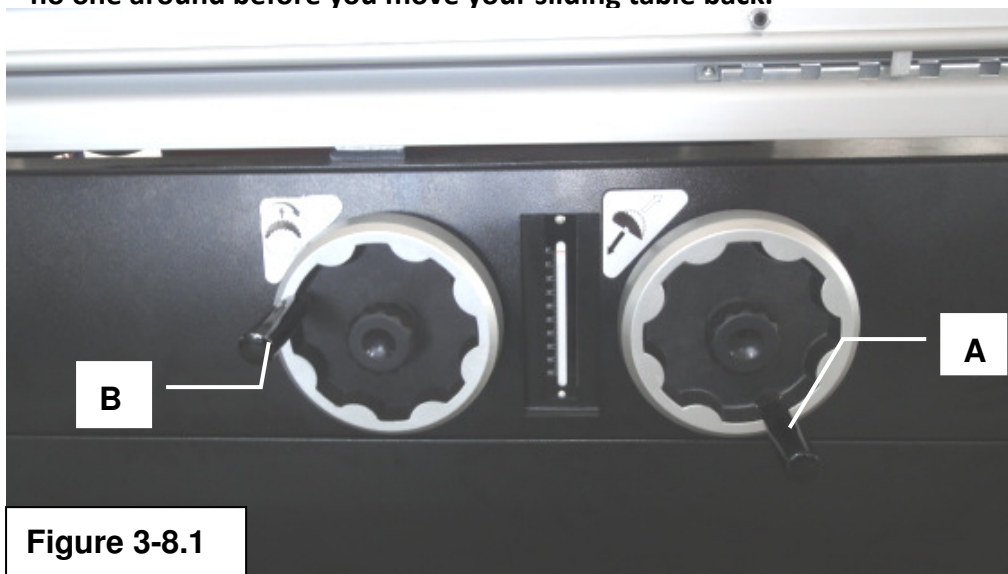

Figure 3-8.1

3. INSTALLATION

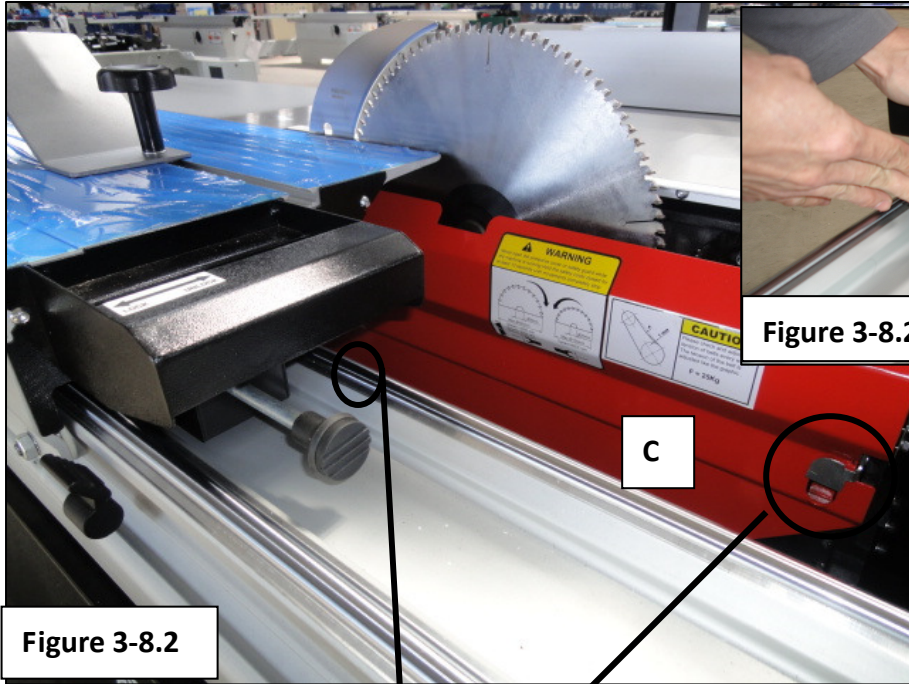

Figure 3-8.2

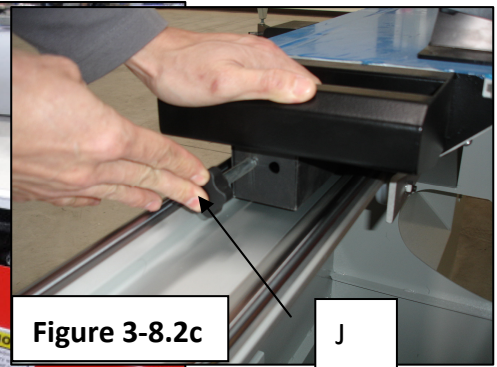

Figure 3-8.2c

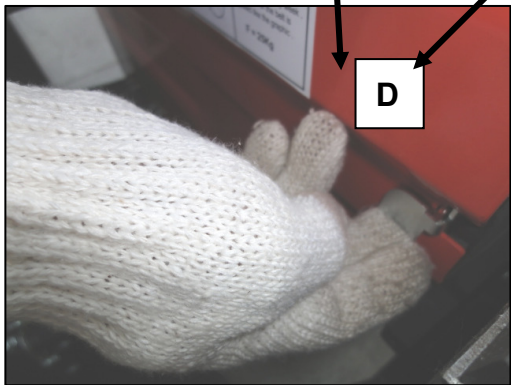

Figure 3-8.2a

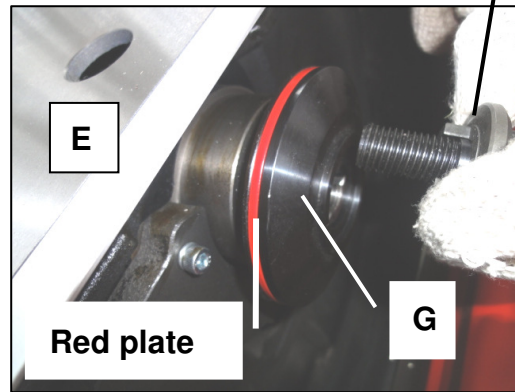

Figure 3-8.2b

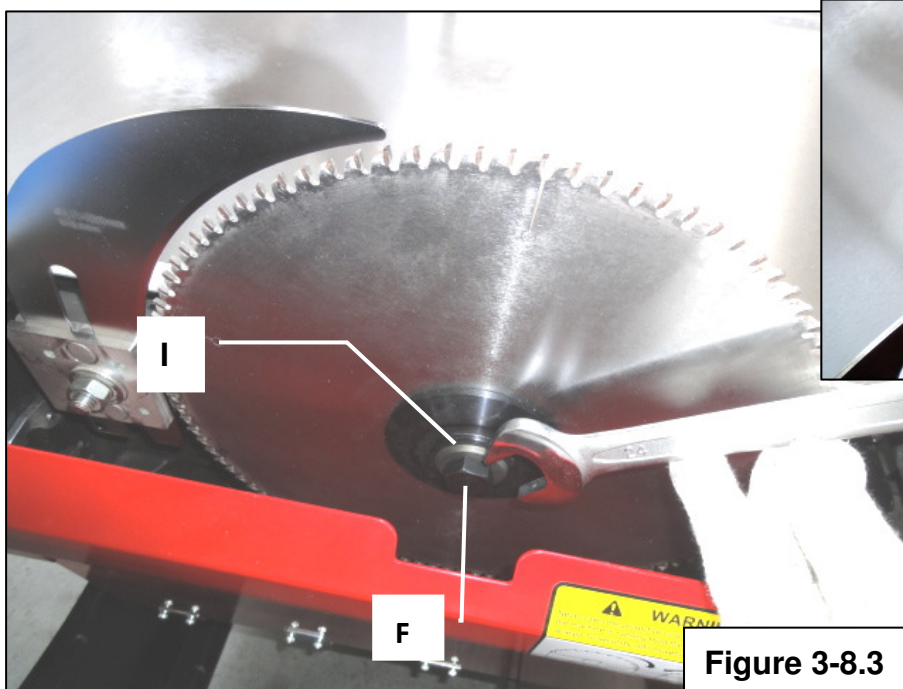

Figure 3-8.3



Figure 3-8.3a

3. INSTALLATION

3-9. RIVING KNIFE

⚠ CAUTION: Always install the riving knife with gloves.

The machine is always equipped with one riving knife for 355mm saw blade.

Always fit the proper riving knife:

1. Loosen nut **A** (Fig. 3-9.1) insert the riving knife with a wrench without complete tightening it.
2. Position the riving knife about 3mm or 1/8" away from the nearest tooth on the main blade. (Gap **B** between saw blade and riving knife shall be 3mm approx.)
3. Tighten the nut **A** to secure the riving knife in the position. (Fig. 3-9.1)
4. Move the blade guard & sliding table back to the original position.

Figure 3-9.1

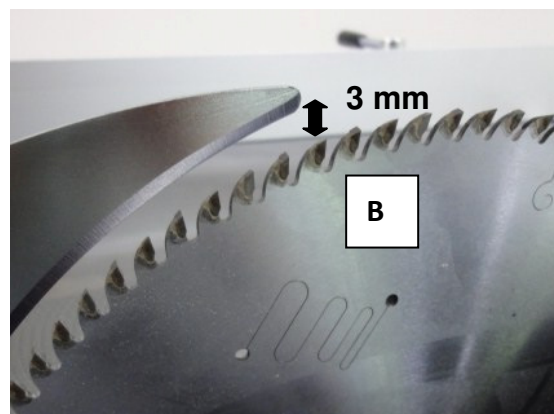
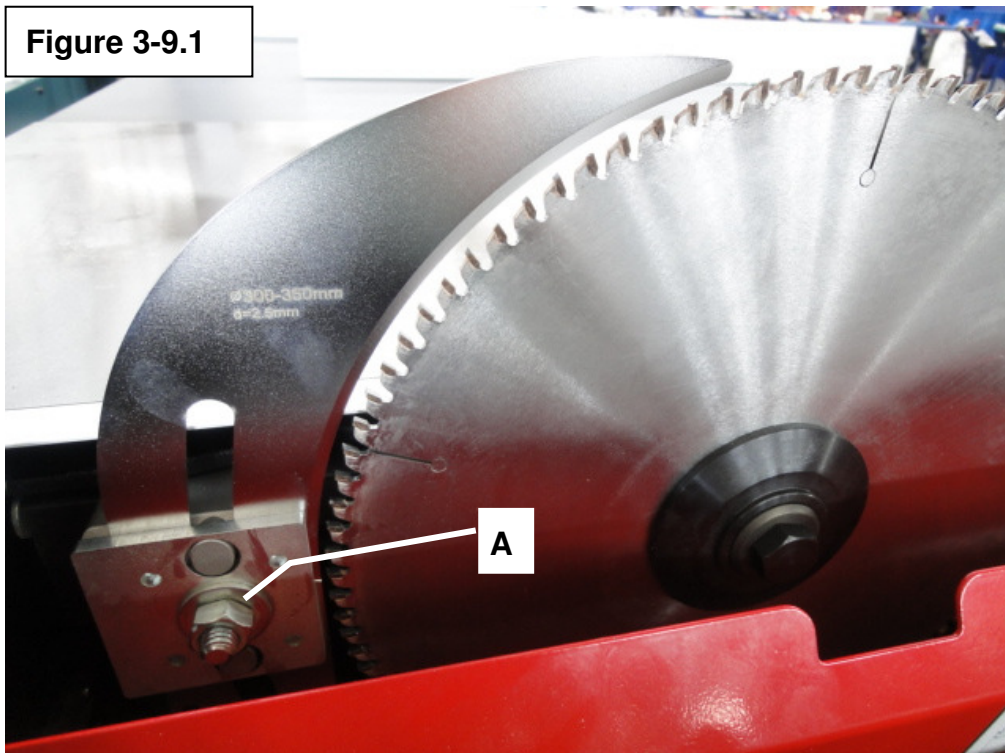

Figure 3-9.1a

3. INSTALLATION

3-10. CHANGING SCORING BLADE

⚠ CAUTION:
Changing scoring blade with gloves and always pay attention.

1. Press the emergency button
 2. Set the scoring blade in 90 degree by turning the hand wheel A (Fig. 3-8.1)
 3. Move the sliding table to the left and push the handle to the 2nd stop before reach the 1st stop. (Fig. 3-10.1)
 4. Open the blade protect guard -red cover(Fig. 3-10.1a)
 5. Hold the spindle in a fix position by inserting the fixing bar C(Fig. 3-10.2)
 6. Loosen nut with hex- wrench
 7. Take off nut and one flange
 8. Make sure that flanges and scoring blade are clean
 9. Fit the scoring blade, flange and nut then tighten nut D(Fig. 3-10.2)
 10. Remove the fixing bar from Table
 11. Close the blade protect guard -red cover(Fig. 3-10.1a)
 12. Release the emergency button
 13. Move the sliding table back to its original position.
- ※ Notice: for safety concern, always close the blade guard when finished, (Fig. 3-10.1); move back the sliding table to the original position
- ※ During the machine operation, pay attention to the saw unit when the blade guard is open

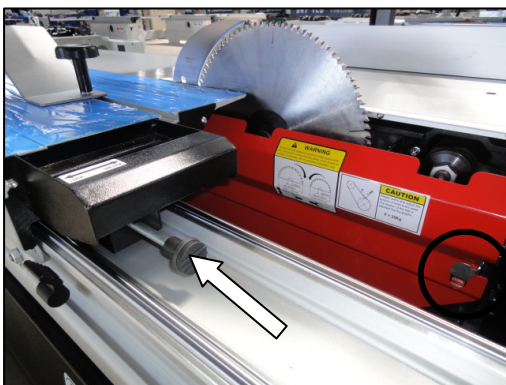

Figure 3-10.1

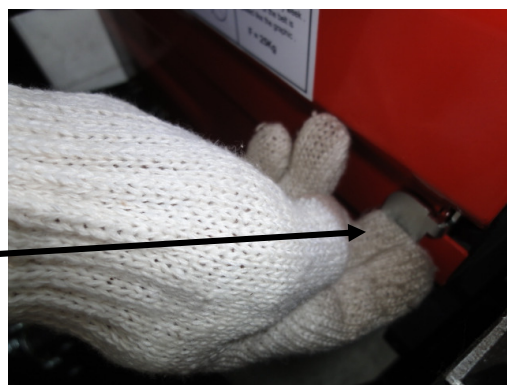

Figure 3-10.1a

3. INSTALLATION

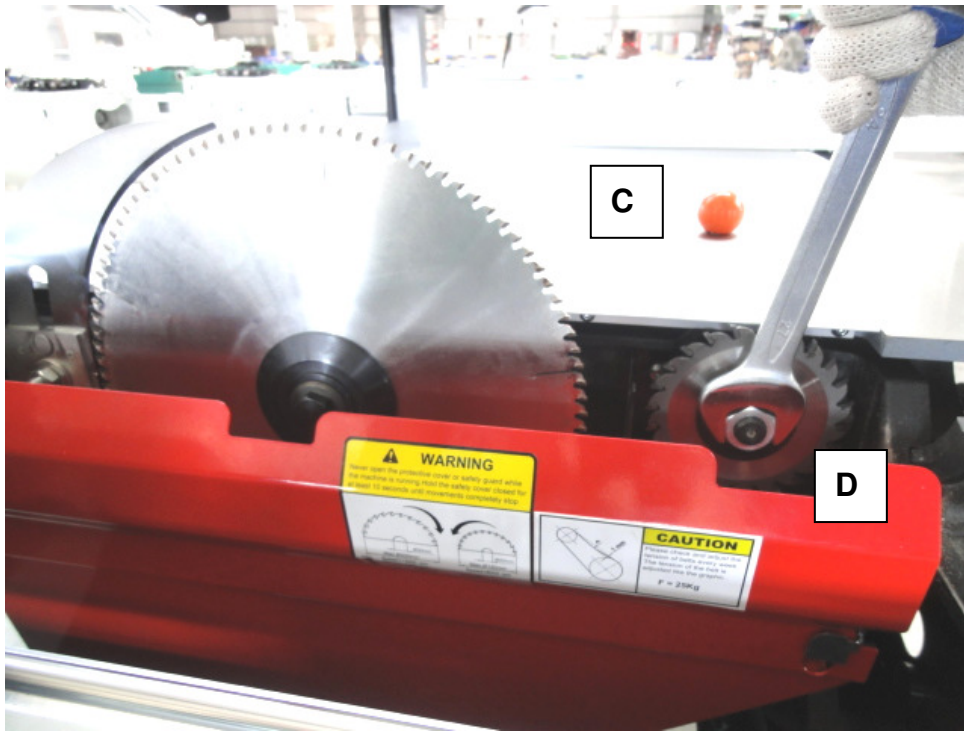

Figure 3-10.2

3. INSTALLATION

3-11. EDGE SHOE, HOLD DOWN & MITER FENCE

Edge shoe

The edge shoe is used for trimming panel and fixes the work piece on the sliding table.

※ Notice: Edge shoe is demanded in heavy duty processing.

Miter Fence with hold down (Optional)

Allows precise miter cuts between + 45 and - 45 on the sliding table and clamps the work piece.

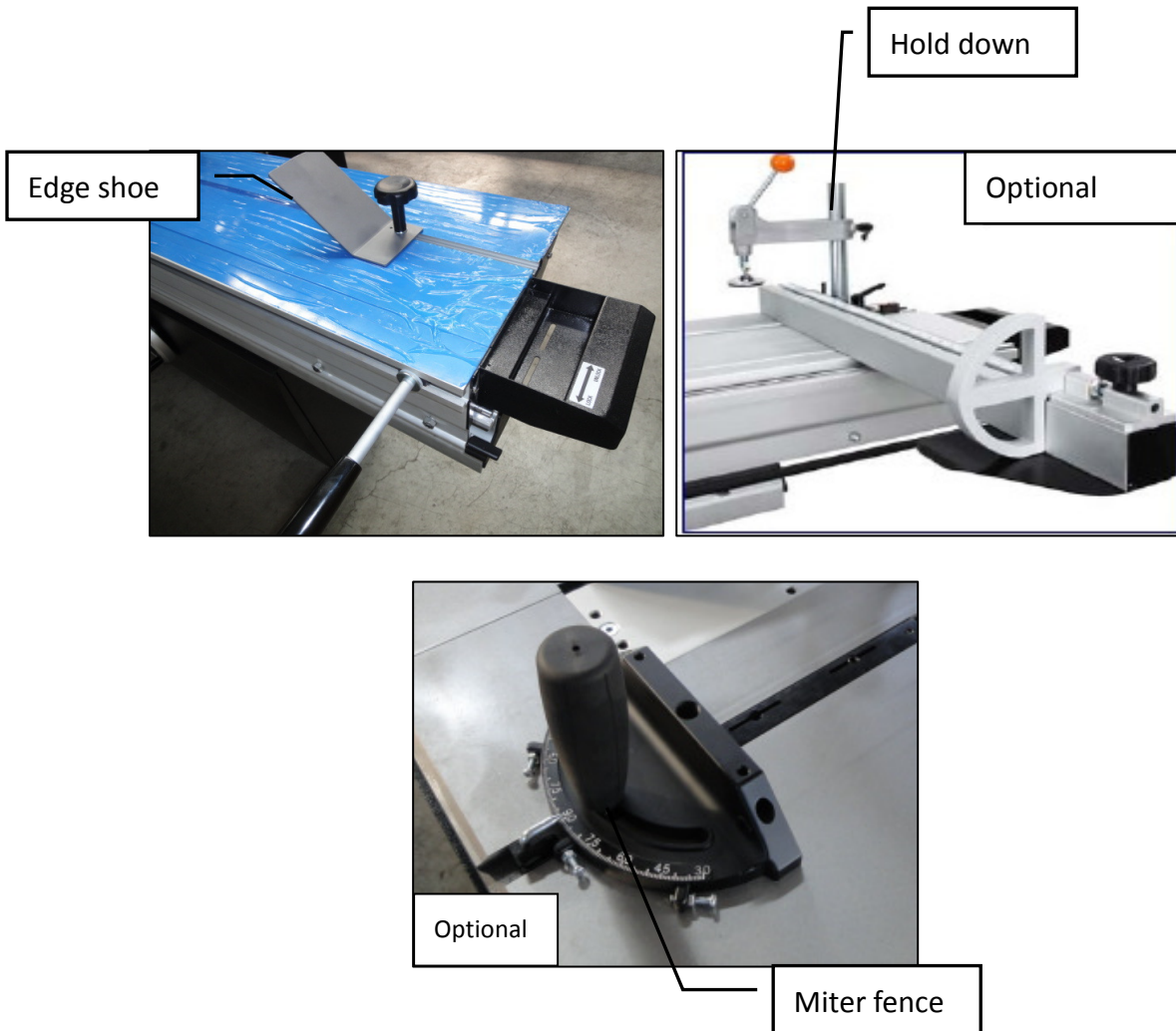

3. INSTALLATION

3-12. CONNECTION TO THE DUST COLLECTION

The connection to the dust collection is necessary for the good machine operation. Always work with the dust collector in operation.

The saw is equipped with two dust ports connected to a dust collection system before operation.

1. Exhaust pipe (Fig. 3-12.1) diameter 120mm
2. Exhaust pipe (Fig. 3-12.2) diameter 102mm

If other machines are connected to the centralized collection system, carry out a test with all collection system in operation.

The right operation of the collection system reduces the risks of dust inhalation.

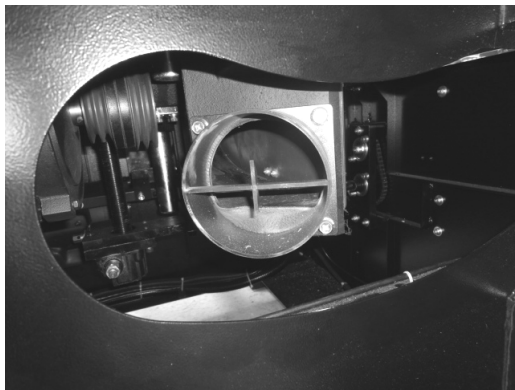

Figure 3-12.1

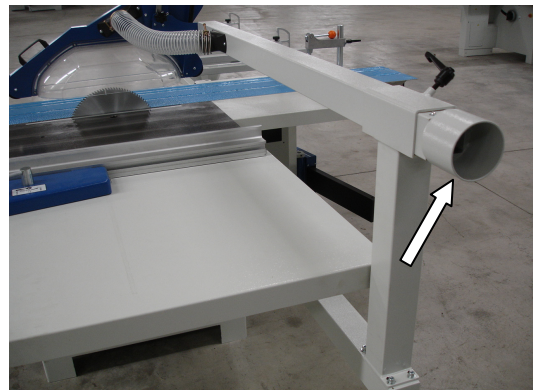

Figure 3-12.2

3. INSTALLATION

3-13. WIRING & TEST RUN

I. WIRING

1. Make sure that the electric system of the workshop may absorb the machine power and the grounding system follows the prescriptions in force.

Notice: Comply with local codes to prevent fire accident.

2. The power cord section need to fit motor power rating
3. Please **CUT OFF** power source before open the terminal box for the electrical connection. The connection terminals for the supply cables are marked with L1, L2, L3, N and PE
4. Make sure all electrical circuits are grounded before you connect them to the machine.
5. If the motor wrong rotary, the power source is connected to the reverse phase. Please change the incoming wire L2 and L3.

II. TEST RUN

1. Turn the main switch ON. (Fig.3.13.2)
2. Test run the main blade rise/fall
3. Test run the main blade tilting
4. Test run the main blade
5. Test run the scoring blade

- ※ Make sure machine operator is to be trained for the use, adjust and operation.
- ※ All operations requiring the demounting of machine components must be carried out only by suitable skilled and authorized personnel. Keep the safety prescriptions as well as the general work safety regulations.
- ※ If any problems happen, press the emergency STOP button. If you need help, please take the troubleshooting section of this manual or contact your local agent.
- ※ Always wear safety glasses, a respirator, and hearing protection and NO smoking when operating this machine

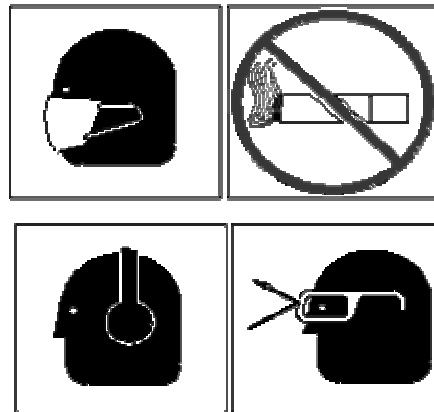

Figure 3-13.1

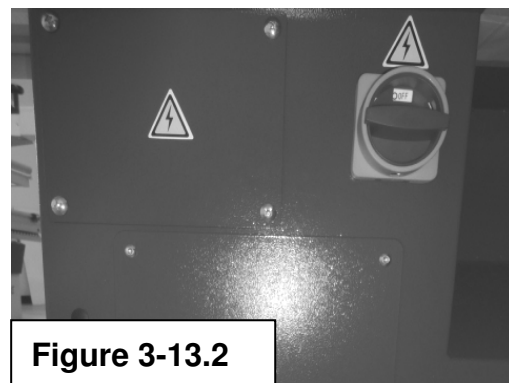

Figure 3-13.2

4. OPERATION

4-1. SAW BLADE LIFTING AND TILTING

I. SAW BLADE LIFTING

1. Turn hand wheel **B** (Fig. 4-1.1) counter clockwise: the saw blade rises.
2. Adjust the saw blade height according to the work piece thickness.
3. The saw blade height must exceeds the piece thickness 1 ~ 1.5cm
4. Set the guard **C** (Figure 4-1.1a) to a max. Height 4 ~ 5mm from the work piece.

II. SAW BLADE TILTING

1. Turn hand wheel **A**(Fig. 4-1.1) to tilt the saw blade up to the demanded degree based on scale

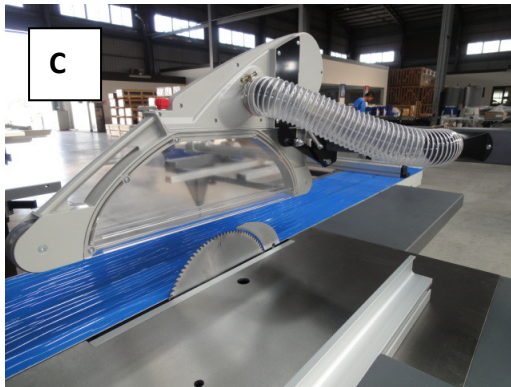

Figure 4-1.1a

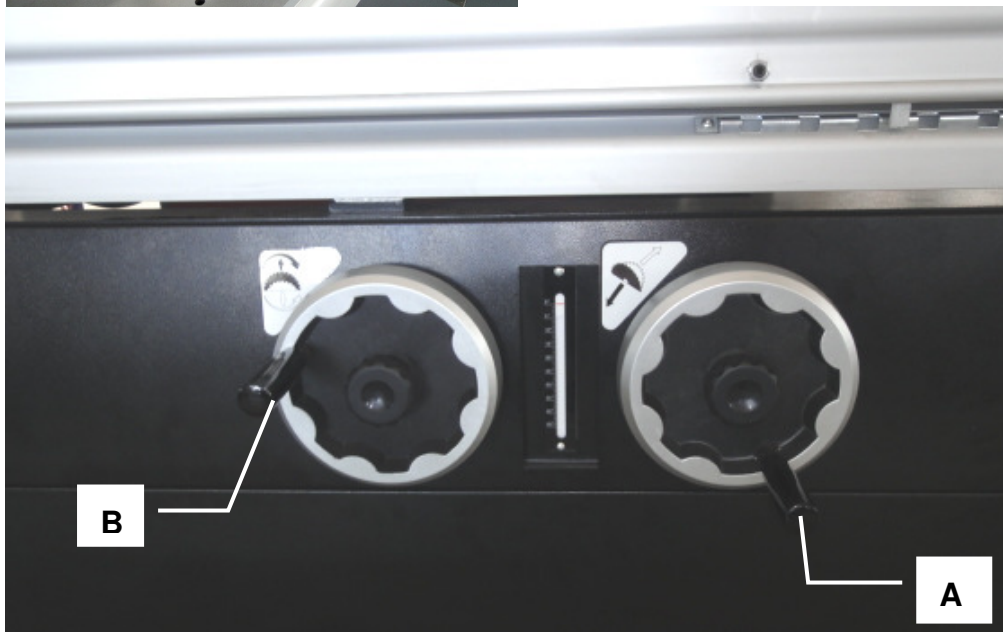

Figure 4-1.1

4. OPERATION

4-2. SCORING BLADE ADJUSTING

I. SCORING BLADE HEIGHT ADJUSTING

1. Loosen nut **A** (Fig. 4-2.1)
 2. Turn the knob **B** (Fig. 4-2.1) till the scoring blade has reached to the height desired, then tighten nut **A** (Fig. 4-2.1)
 3. The projection adjusting range varies from 0 to 5mm
- ※ NOTE: When it is not necessary to use the scoring blade, make it lower than the table.

II. ALIGNING THE SCORING BLADE WITH THE SAW BLADE :

1. The operator has to do some cutting tests.
 2. Loosen nut **C** (Fig. 4-2.1)
 3. Turn draw bar **D** (Fig. 4-2.1) to the desired position, and tighten nut **C** (Fig. 4-2.1)
turn clockwise, the scorer move to left turn counter clockwise , the scorer move to right
 4. The range for traverse adjustment of the scorer is approx. +/-2mm
- ※ NOTE: Test cut to check the alignment is necessary.

▲ CAUTION:

During the machine use with scoring unit, pay attention when the sliding table is totally on the left, a part of the blades remains uncovered. (Figure 4-2.2)

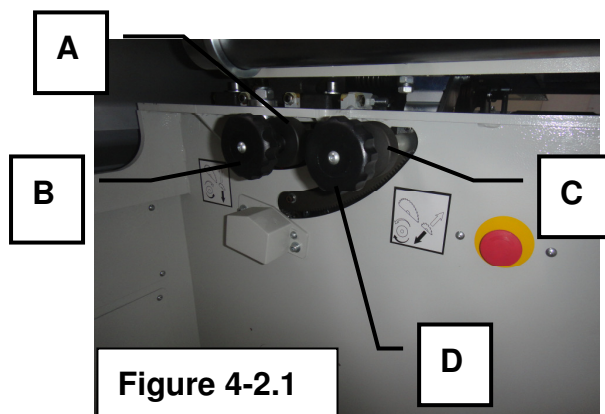

4. OPERATION

III. USE OF SCORING BLADE

The scoring blade is used to avoid the chipping on the bottom part of panels coated with finishing material. Take Fig 4-2.3 as reference.

- A. Single blade: with blade thickness equal to the saw blade one.
- B. Double blade: If you fit proper shims between the two elements, you get the same thickness of the saw blade or a larger thickness.
- C. Conical scoring blade: For aligning with saw blade of different thickness or for obtaining two chamfers on two panel edges.

If the edge which shall not be is only one, the scoring blade may have any shape and dimension.

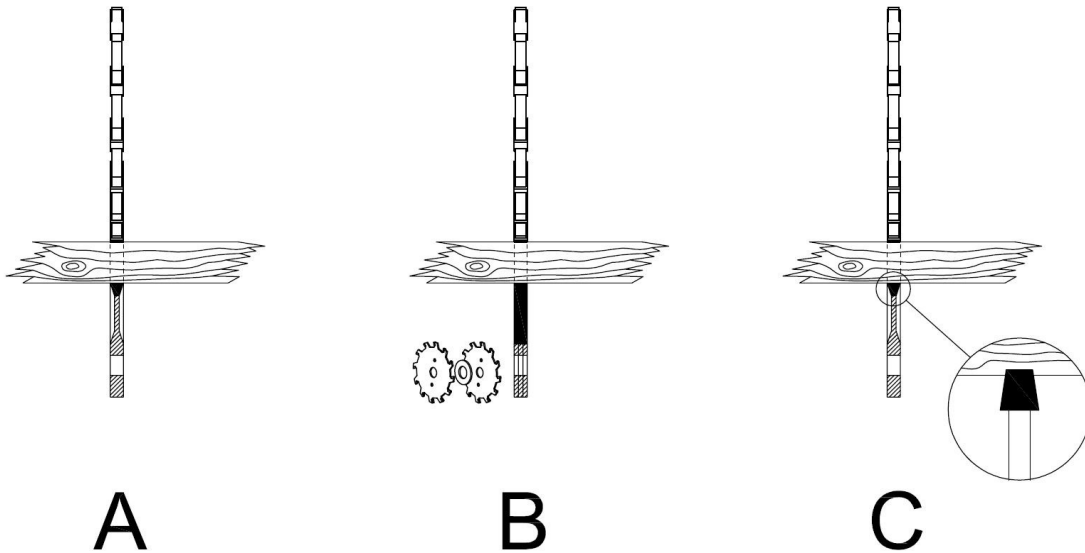
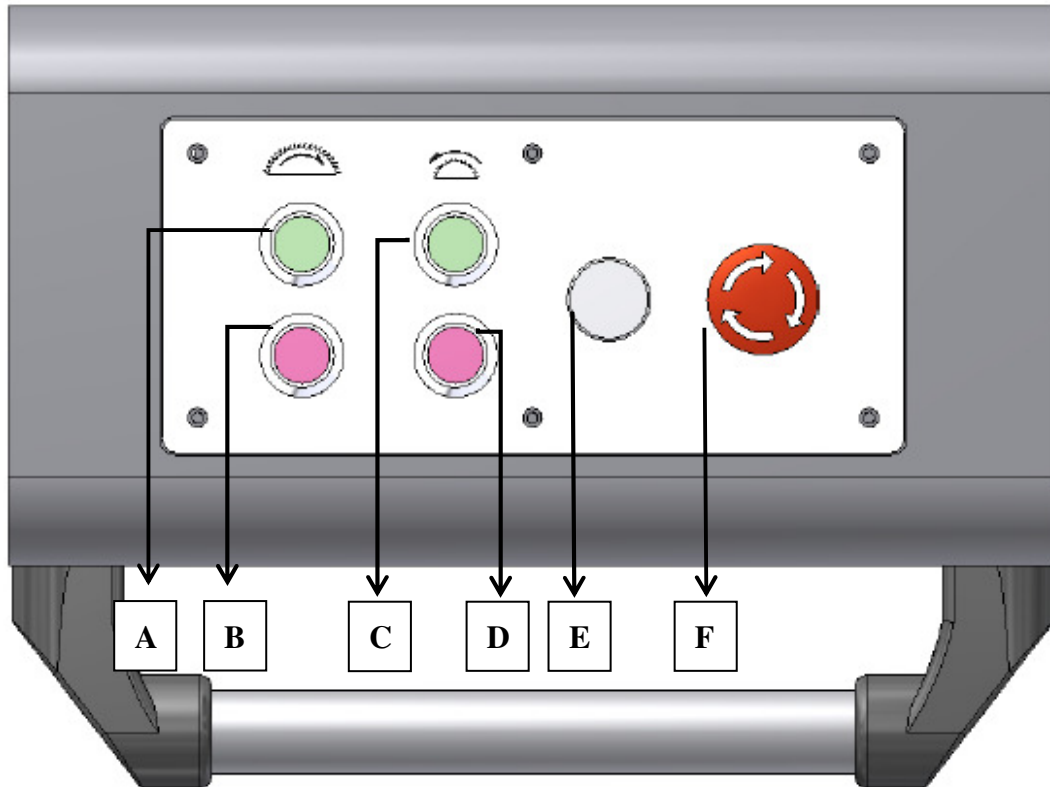

Figure 4-2.3

4. OPERATION

4-3. CONTROL PANEL OPERATION



Control panel close-up

- A.** MAIN BLADE ON Button—Start the main saw blade.
- B.** MAIN BLADE OFF Button—Stop the main blade.
- C.** SCORING BLADE ON Button—Start the scoring blade.
Note: The main saw blade must be ON for the scoring blade to start.
- D.** SCORING OFF Button—Stops the scoring blade.
- E.** POWER LIGHT.
- F.** EMERGENCY STOP Button—Disconnects power to all motors in the motor cabinet

4. OPERATION

4-4. 3 SPEED CHANGE

1. Set the saw unit down
 2. Stop the machine , turn the main switch to 0 ; then lock it and indicating this with a sign
 3. Open the rear door
 4. Loosen knob **A**(Fig. 4-4.1)
 5. Lift lever **B**(Fig. 4-4.1) of belt stretcher to the end of stroke, then tighten knob **A**(Fig. 4-4.1)the belts will slack and can be replaced
 6. Set the belts in the proper position (the smallest dia. gap set as 5000rpm, the middle dia. gap sets as the smallest dia. groove set as 5000rpm, the middle dia. groove set as 4000rpm, the largest dia. groove set as 3000rpm.
 7. Loosen knob **A**(Fig. 4-4.1)
 8. Move lever **B**(Fig. 4-4.1) of belt stretcher to initial position (which is totally down) to stretch the belts
 9. Tighten knob **A**(Fig. 4-4.1)
 10. Close the rear door
- ※ *NOTE: Make sure that the selected rotation speed is proper for the working and for the saw blade.*

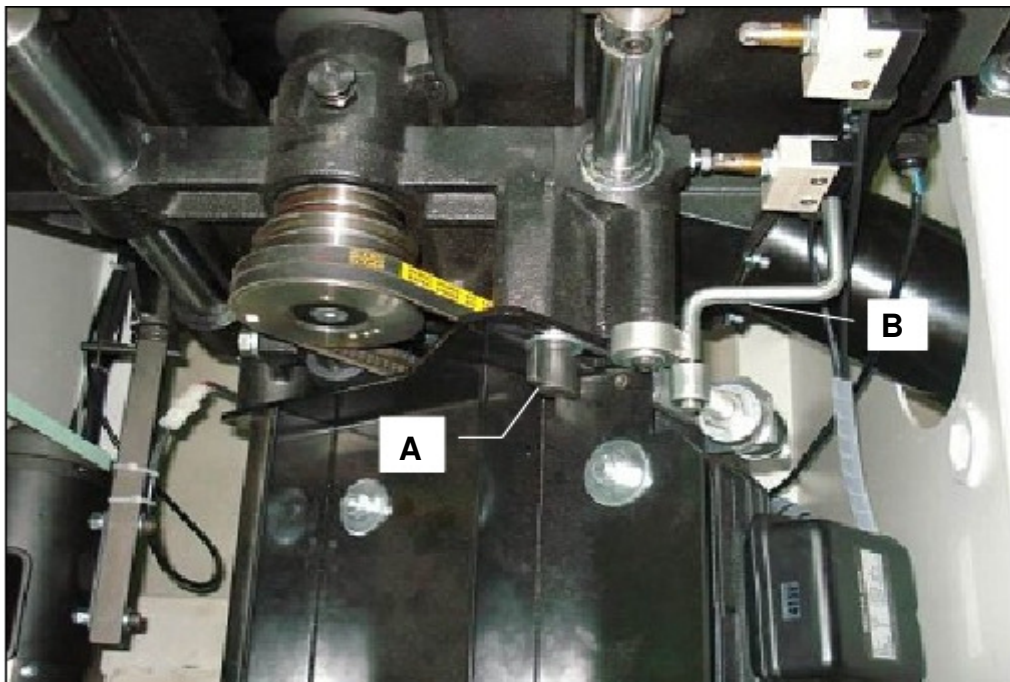

Figure 4-4.1

4. OPERATION

4-5. SETTING THE RIP FENCE UNIT FOR PARALLEL CUTS

Make sure the distance value before operation

1. **Turn off power** , and lift the saw guard
2. Unlock the rip fence unit **A**(Fig. 4-5.1) by loosening knob **F** (Fig. 4-5.1) & pull up handle **B**(Fig. 4-5.1) then move it in order to read a value on the blade and millimeter rule of edge **C**(Fig. 4-5.1)
3. Measure the distance **D**(Fig. 4-5.1) between saw blade and fence plate
4. If measured values on step 3& 4 are not the same, loosen ruler screws and washers then **move millimeter rule** until these values are matched (Fig. 4-5.1).

Note: operator can do micro-adjust by using knob E after locking knob F (Fig. 4-5.1), then push lever B down to fix the rip fence unit.

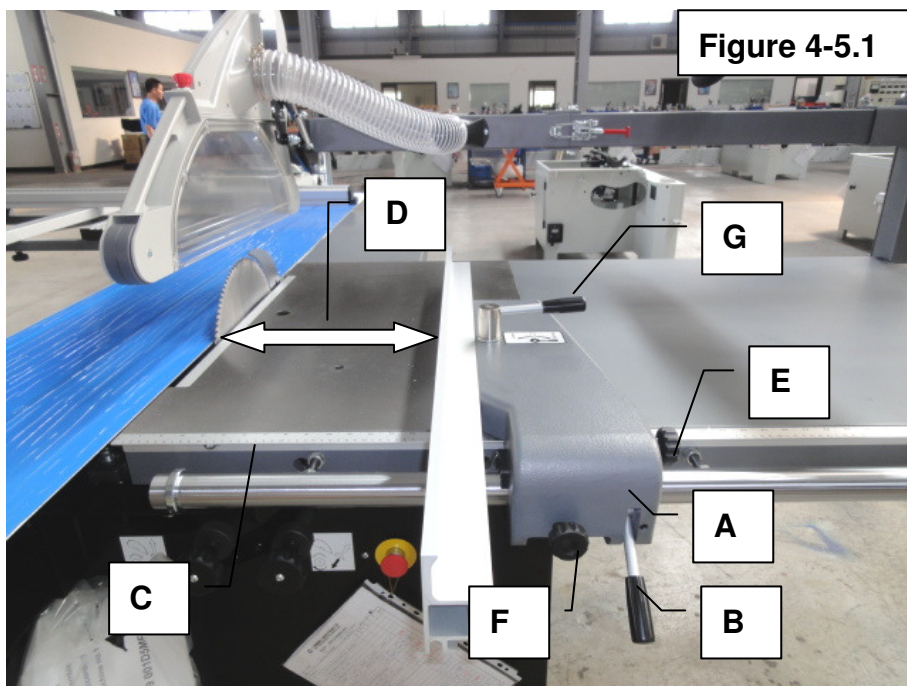

4. OPERATION

I. ADJUSTING THE RIP FENCE UNIT FOR PARALLEL CUTS

1. Move sliding table **G**(Fig. 4-5.3) lock knob **H**(Fig. 4-5.3)
2. Lift lever **A** (Fig. 4-5.2) for unlocking the fence unit.
3. Move the fence unit to the desired position (readout the value on millimeter rule **C**(Fig. 4-5.2))

Micro-adjust rip fence:

1. Turn knob **B**(Fig. 4-5.2) to lock rip fence
2. Pull lever **A** up (Fig. 4-5.2) and turn knob **D** (Fig. 4-5.2). Then the fence unit can be **micro-adjusted** to distance of operator's choice.
3. After reaching the measure, lock the fence unit by lowering lever **A**(Fig. 4-5.2)
 - ※ Note: fence **E** (Fig. 4-5.2) can move in longitudinal direction after unlocking handles **F** (Fig. 4-5.2). After every adjustment, tighten handles to ensure the calibration of rip fence.

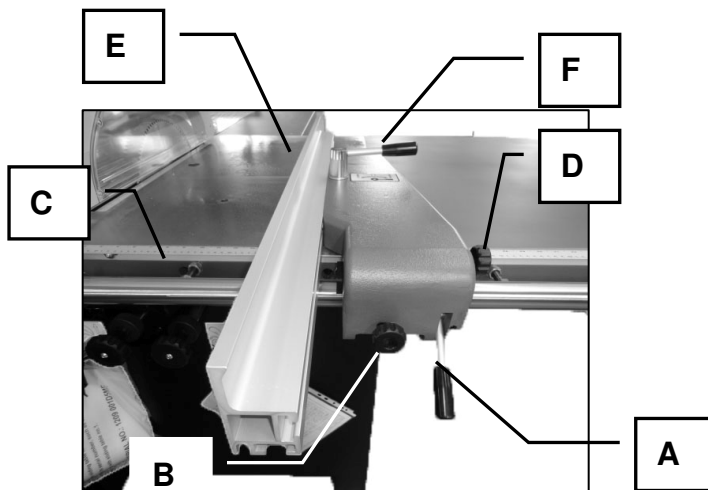

Figure 4-5.2

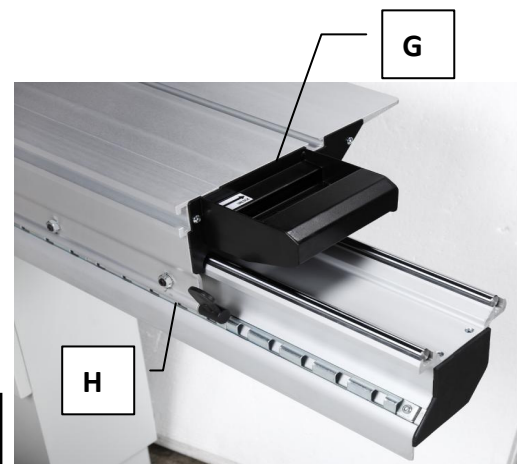

Figure 4-5.2

4. OPERATION

II. POSITION OF FENCE PLATE

1. Vertical position (Fig. 4-5.4a) turn to the work piece
2. Horizontal position (Fig. 4-5.4b) for cutting thin work piece and for slanting cuts.
It will be safer to move the work piece forwards by using pusher.

⚠ NOTE:

For the execution of special working, the operators are obliged to put his hands near the tools. However, based on safety reasons, they could use a proper pusher to move the work piece forwards, push it against the fence or to move it away after cutting.

3. Tighten the handle F (Fig. 4-5.2).

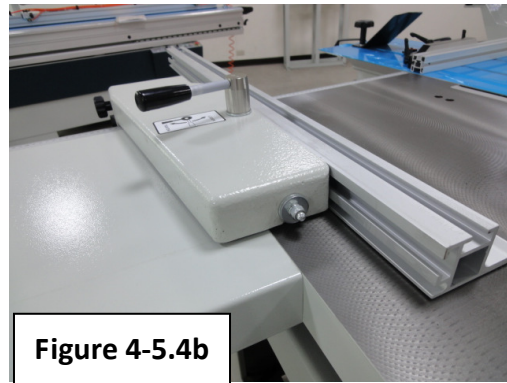
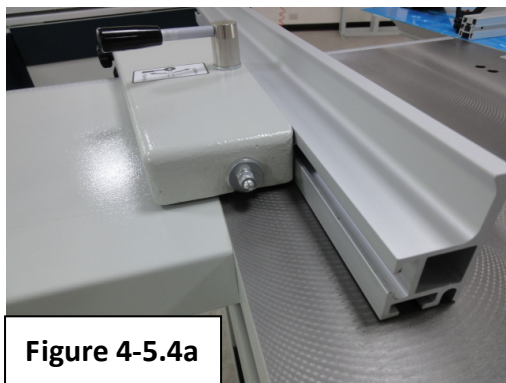

✂ Steps to take the rip fence unit out :

1. Loosen lever A (Fig. 4-5.2)
2. Loosen knob B (Fig. 4-5.2)
3. Lift the whole rip fence unit and turn it **90° counter clockwise**. (Fig. 4-5.5a&b)
4. Lightly move rip fence unit out from the round bar by passing through the metal locker.

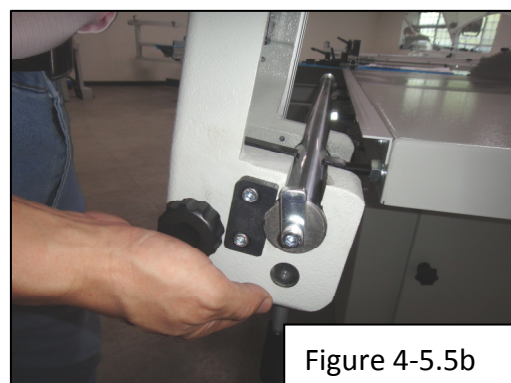
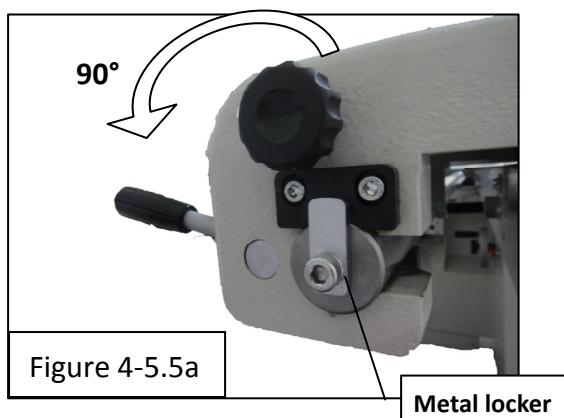

4. OPERATION

4-6. SLIDING TABLE

⚠ CAUTION:

Lock sliding table before placing heavy work piece for safe location.

The sliding table is moved on high precision sideways which is made of hardened steel for a uniform and smooth motion with less friction and obtain accurate cutting.

The sliding table is locked and unlocked by lever **A** (Fig. 4-6.1)

- Lever up: sliding table unlocked
- Lever down: sliding table locked

I. USE OF SLIDING TABLE AND FRAME FOR LARGE PANELS

Longitudinal positioning of the frame

Lock/Unlock the sliding table by means of rod **A** for placing large work piece

1. Move the frame for your desired position with handle **B** (Fig. 4-6.1)
 2. Lock knob **A** (Fig. 4-6.1) for fixing.
- ※ To remove the sliding table of the machine over the saw blade center, please move the sliding table a little back for opening the second positioning design

II. USE OF THE HOLD DOWN

1. Loosen handle to adjust the foot height
- ※ To ensure a strong panel clamping, the foot shall be at a **2mm** height from the panel surface before lowering the lever.
2. By means of lever **H**(Fig. 4-6.2) lower foot **F**(Fig. 4-6.2) for clamping the work piece

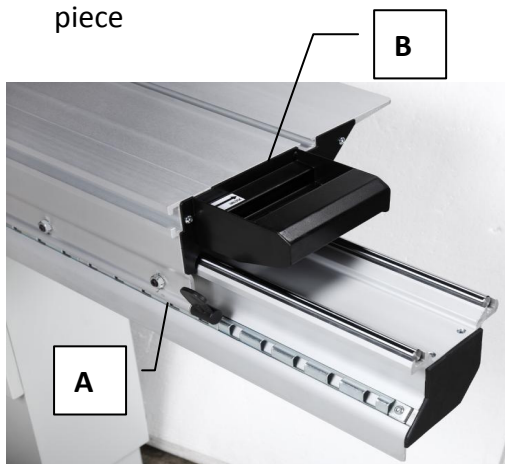

Figure 4-6.1

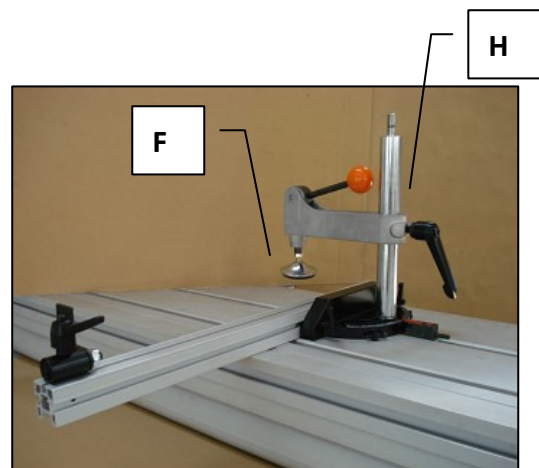
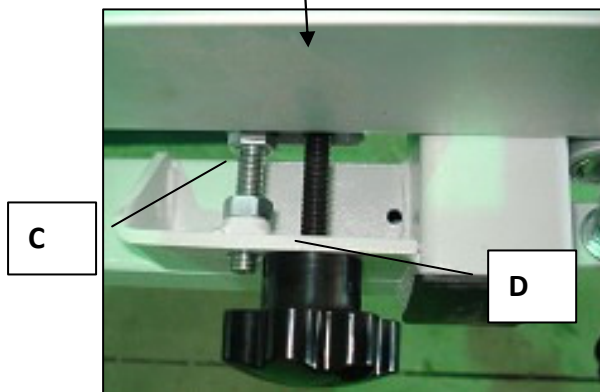
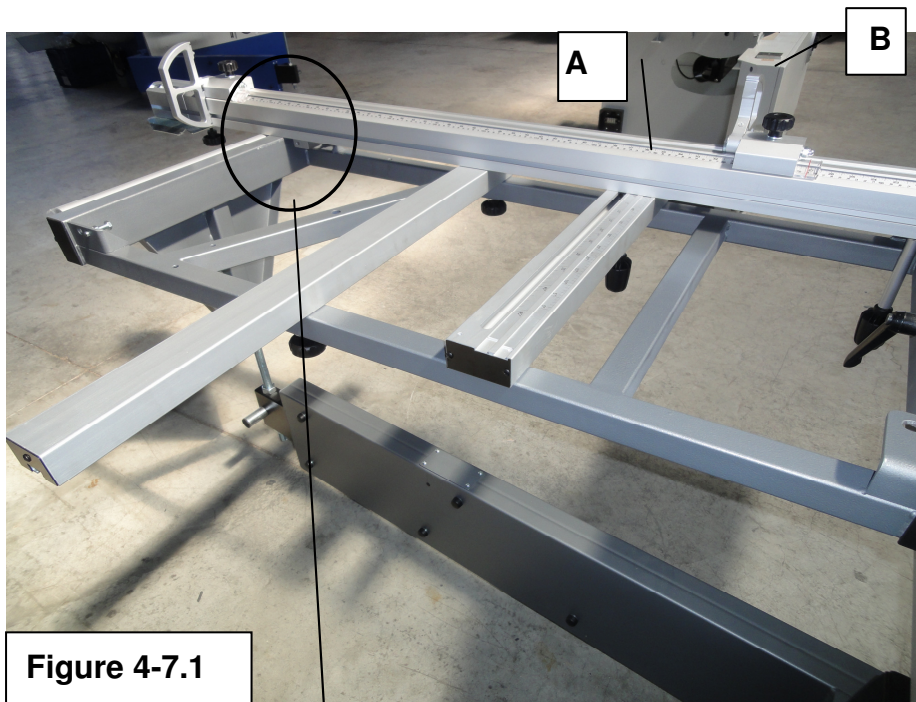

Figure 4-6.2

4. OPERATION

4-7 SETTING THE CROSSCUT FENCE

1. Turn threaded nut **C** (Fig. 4-7.1a) to make crosscut fence exactly vertical with sliding table. Then lock knob **D** (Fig. 4-7.1a) to fix A (Fig. 4-7.1).
2. Turn on the machine, then trimming the panel with the crosscut fence.



4. OPERATION

I. SQUARE CUTTING TEST

1. Lock all knobs for crosscut fence.
2. Lower the guard, then do test trimming to A, B, C & D (Fig. 4-7.2) of the testing panel.
3. After cutting, measuring the cutting width of E & F (Fig. 4-7.2). As a test for square cutting, the length of them MUST be the same.
 - If they are not the same, operator must:
 1. Make sure the crosscut fence and sliding table are exactly vertical.
 2. Readjust the screw C (Fig. 4-7.1a) and make crosscut fence and sliding table exactly vertical.
 - If they are the same, then the testing procedure finished.

II. EXTEND MILLIMETER RULE

For cutting panels of width exceeding 1860mm, you have to use the extension part A (Fig. 4-7.3) and follow steps below:

1. Loosen knob B (Fig. 4-7.3)
2. Move extension part A (Fig. 4-7.3).

Note: point C (Fig. 4-7.3) indicates the width value.
3. After move the extended millimeter rule to your desired length by read out the value from point F (Fig. 4-7.3), tighten the knob B (Fig. 4-7.3) for fixing.

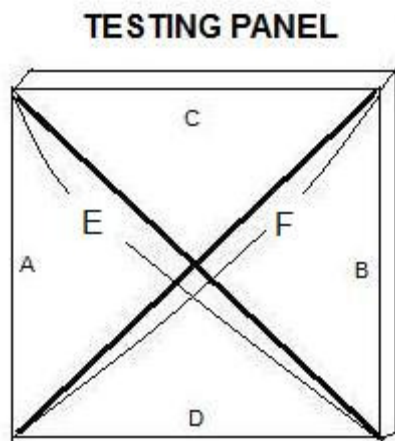

Figure 4-7.2

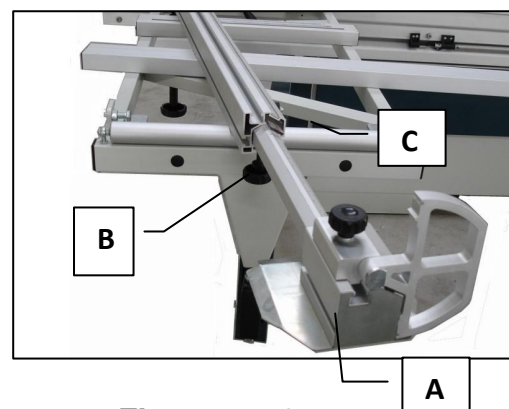

Figure 4-7.3

4. OPERATION

III. RULE ADJUSTING FOR OBLIQUE CUTS

1. Loosen knob **D**(Fig. 4-7.4a)& **F**(Fig. 4-7.4b) to change position of crosscut fence
2. Adjust the position for making sure the right side of the fence **A** (Fig. 4-7.4) aligning with the desired angle.

※ Note: **B** (Fig. 4-7.4) part indicates the angle value.

3. After adjust it to your desired angle, tighten the knob **F**(Fig. 4-7.4b).

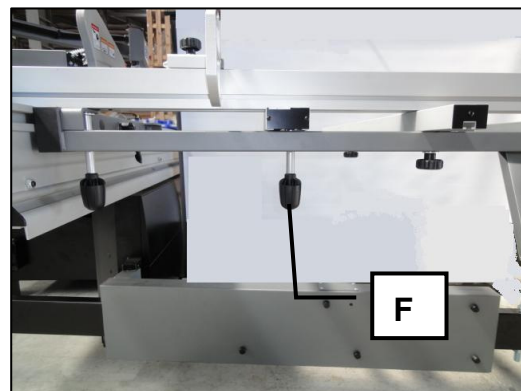
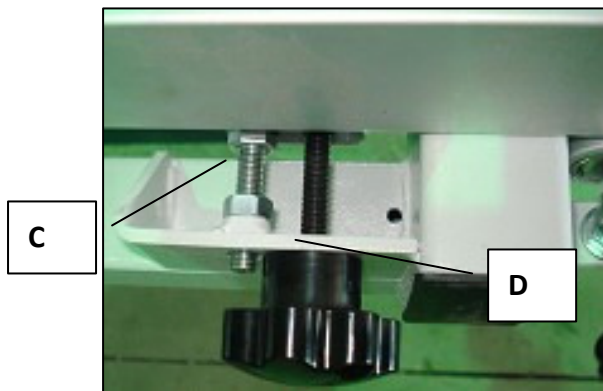
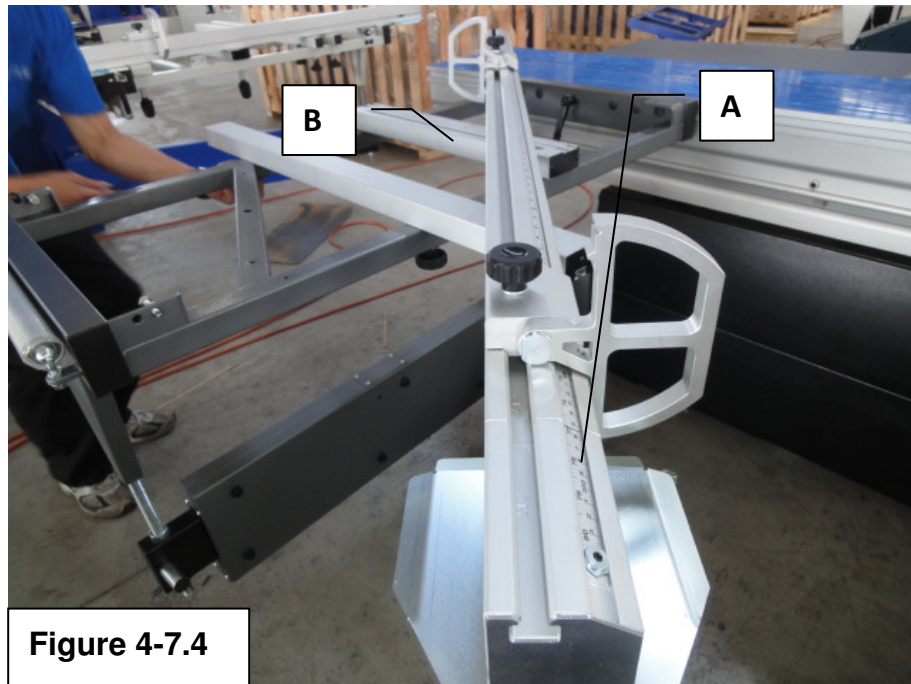

5. MACHINE MAINTAINNESS

5-1. Machine cleaning & check

Before carrying out maintenance, adjustments or demounting any machine member, turn the main switch to 0. Then lock it and indicate this with a sign.

The general cleaning can extend life of usage for the machine and it would also affect operation safety.

Using aspirator to clean the machine:

- ✓ Eliminate dust and chips from the table and all cavities
- ✓ Weekly clean all moving parts in particular the elements exposed to the dust and to the resin by using a brush or cloth with safe solvent.
- ✓ Clean carefully: clean guides of crosscut fence, sideways of the sliding table, rod of the fence, and groove by safe solvent.

CHECK OF SAFETY DEVICES

For safe usage of the machine, the safety devices shall be efficient.

Check the controls for emergency stops every 2 weeks with a test. With the machine under normal operating condition, press the emergency button arranged on the machine, the saw blade shall stop.

- ※ NOTE: If the belts get slack, the braking time may increase. Therefore, make sure that the belts are stretched or in good condition.

MACHINE REMOVAL - STORING

▲ CAUTION

Stop processing and contact the local agent a.s.a.p. while the machine has troubles.

Disconnect the machine from the electrical and pneumatic system. After totally clean the machine, wipe antirust protection on it, and preventing the machine in environment.

5. MACHINE MAINTAINNESS

Cleaning & Checking Schedule

Check items	Daily	Weekly	Monthly	3-month	6-month	yearly
Check emergency stop and indicate lamp whether normal or not?	✓				✓	
Check the integrity of noise, pressure and ventilation of the machine.	✓			✓	✓	
Clean the exterior part of the machine	✓		✓			
Check all the screws from the machine whether tight or not?					✓	
Check screws and nuts of limit switch whether tight or not?	✓				✓	✓
Check all wires and electric connections near the power switch to see if there have any			✓		✓	✓
Check belt running normal or not? If any break or failure, replace it.	✓		✓		✓	
Check the load voltage and current of the motor			✓			✓
Check the continuity of all the wires		✓				
Clean the interior part of the electrical box and check the continuity of the wires.			✓			
Tighten the terminal screws of the power supply wires in the control box					✓	
Any worn or damaged parts and unsafe condition.	✓			✓		
Clean & vacuum dust buildup from inside cabinet.			✓			

5. MACHINE MAINTAINNESS

5-2. PERIODICAL LUBRICATION

An accurate lubrication ensures the long life of usage as well as the best performance of the machine.

Weekly lubricate with grease

Worms B (Fig. 5-2.1) and toothed sector A (Fig. 5-2.2) for height adjusting and tilting of the saw blade

⚠ CAUTION
Disconnect the electrical and pneumatic system before maintenance

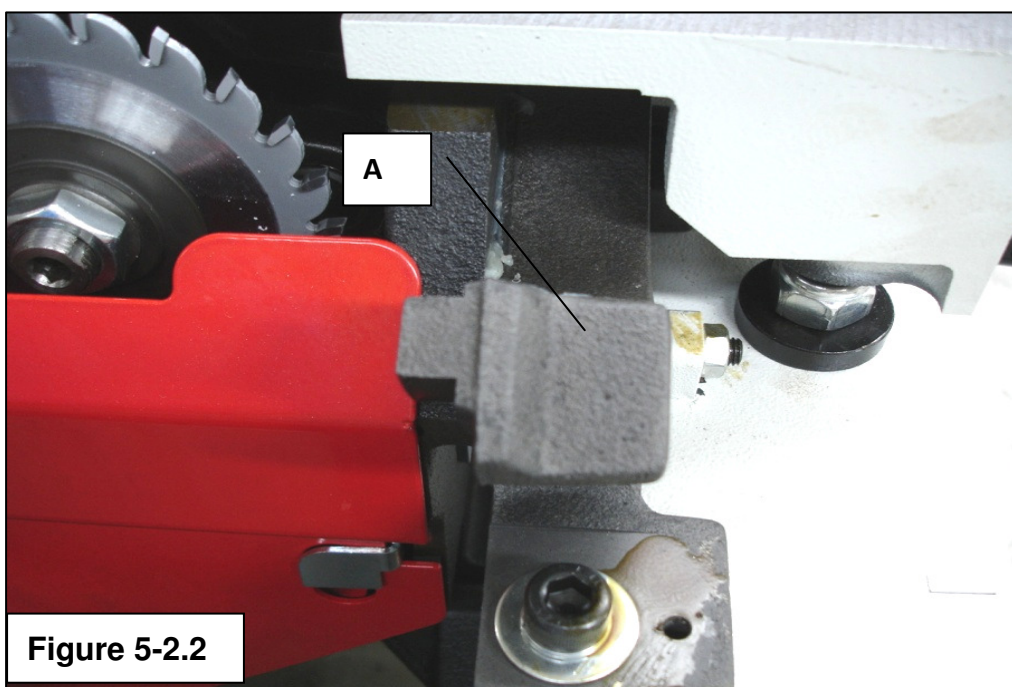
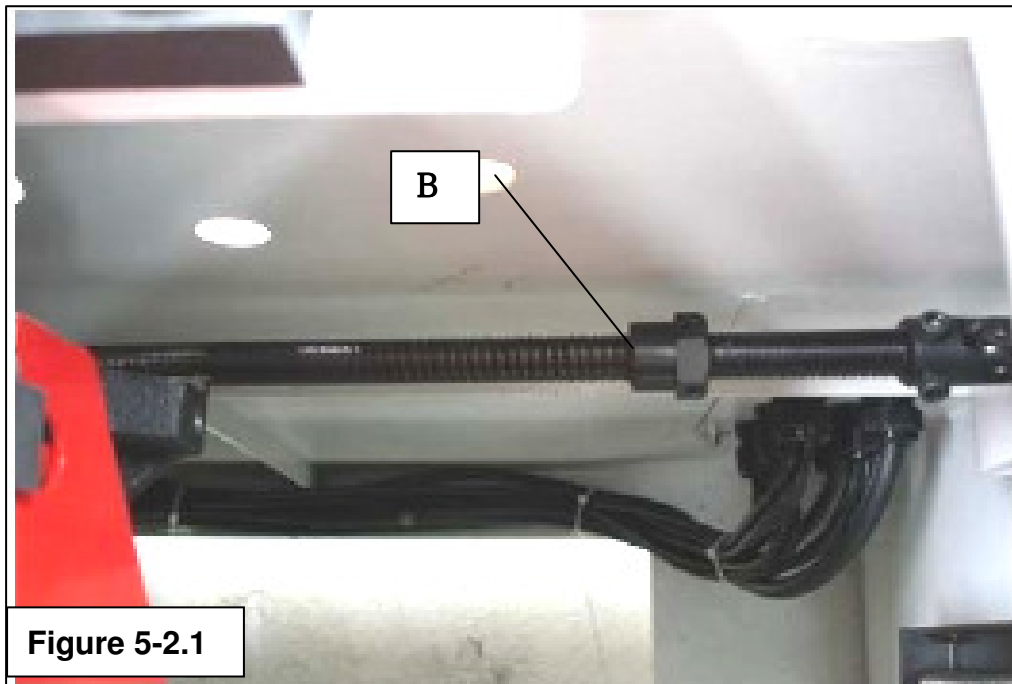

5. MACHINE MAINTAINNESS

5-3. REPLACING BELT

Disconnect the machine from the electrical and pneumatic system

I. REPLACING THE SCORER SPINDLE BELT

1. Remove the rear door
2. Lift the small motor A (Fig. 5-3.1). When the belt is slack, it can be replaced
3. Replace the new belt then lower the motor.

Note: Be aware of the arrow direction marked on the belt and follow it to fit the belt.

4. Manually make the belt cover 2 or 3 complete turns, so that it can get the right settling.
 5. Fit the rear cover again
- ※ The belt will always be stretched by the motor weight.

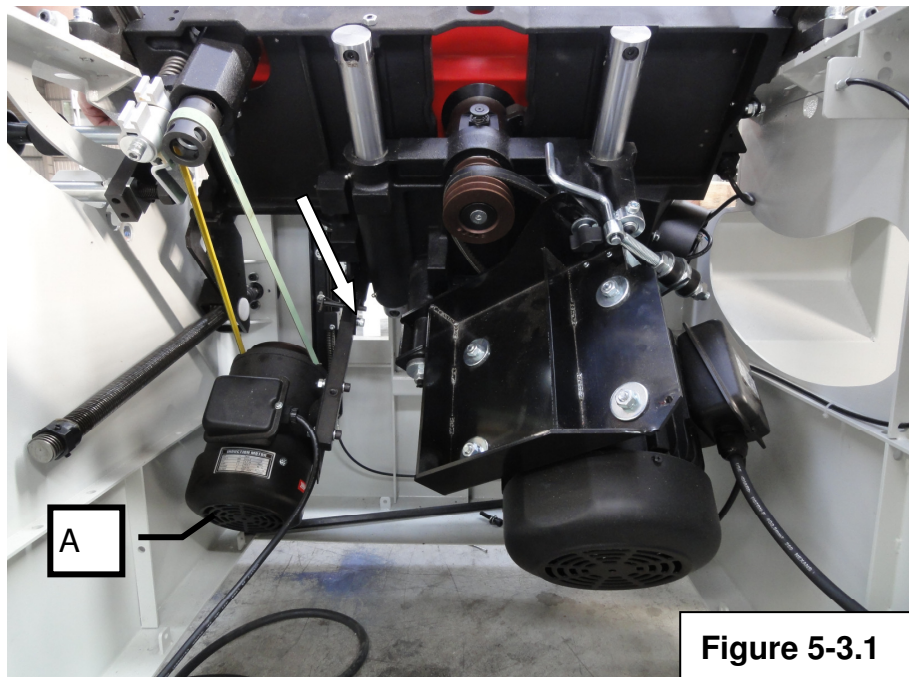

5. MACHINE MAINTAINNESS

II. REPLACING THE SAW SPINDLE BELTS

1. Set the saw unit 45° tilted by turning the wheel.
2. Open rear door
3. **Loosen knob B(Fig. 5-3.2)**
4. Lift lever **C** (Fig. 5-3.2) of belt stretcher to the left, then the belts are slack and can be replaced.
5. Set the belts in the proper places
6. Move lever **C** (Fig. 5-3.2) of belt stretcher to initial position (which is totally down at the right) to stretch the belts.
7. Tighten knob **B**(Fig. 5-3.2), and close the rear door"

Note: Never replace the two belts separately. Replace belts in pair instead of only one belt is necessary.

III. BELT STRETCHING

It is normal that belts get slack after long term operation and working period. When it is slack, the time required to stop the saw blade will be increased. So periodically check this part is necessary.

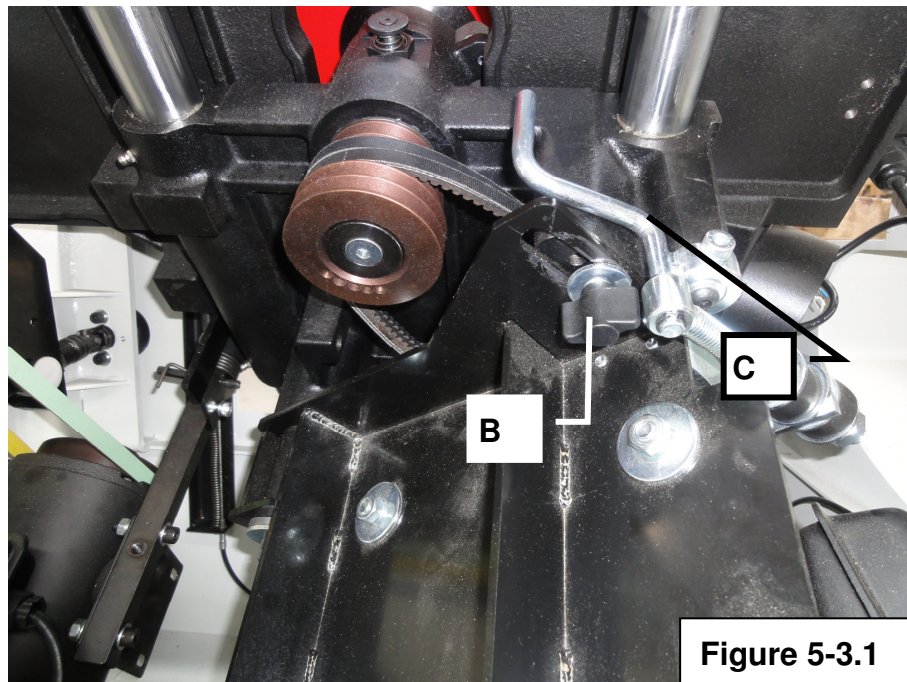

6. TOOLS LIST

TOOLS INVENTORY

- Tool Box
- Riving Knife 300~350mm
- Open spanner 19, 24~27,30mm
- Rob for fixing spindle
- Push Stick



7. TROUBLESHOOTING

WARNING-Disconnect the machine from the power source before troubleshooting or serious personal injury could occur.

Problem	Possible cause	Troubleshooting
The machine cannot be switched on.	<ol style="list-style-type: none"> 1. Door in machine frame or saw blades cover plate is opened. 2. Control circuit fuses defective. 	<ol style="list-style-type: none"> 1. Close the machine door or cover plate. 2. Turn off the main switch, open the switch cabinet and identify which of the fuses is defective and remove it. Replace new fuses, only using fuses of the same rating!
The machine switches off automatically during operation.	<ol style="list-style-type: none"> 1. Power failure in one or several phases due to responding factory fuses. 2. Overload protection has responded due to blunt saw or excessive feed speed. 3. Control circuit fuses defective. 	<ol style="list-style-type: none"> 1. Eliminate cause of phase failure. 2. Change saw blade or reduce feed speed. Allow motor to cool down. 3. Turn off the main switch, open the switch cabinet and identify which of the fuses is defective and remove it. Replace new fuses, only using fuses of the same rating!
Motor will not start, or it growls on start up.	<ol style="list-style-type: none"> 1. Emergency stop button is depressed. 2. Power supply fuse or circuit breaker has tripped. 3. Thermal overload has tripped. 4. Toggle switch is broken inside. 5. Start capacitor is at fault. 6. Motor fan cover is dented, stopping the fan from being able to spin. 7. Motor is at fault. 	<ol style="list-style-type: none"> 1. Rotate the button clockwise and allow it to pop out. 2. Disconnect power, and inspect circuit for electrical shorts and repair. Replace circuit breaker if it is old or has tripped many times. 3. Reset the thermal overload. 4. Disconnect power, and use an ohmmeter to check switch terminals for continuity, and replace switch if required. 5. Replace start capacitor. 6. Replace motor fan cover (and fan, if damaged). 7. Replace motor.

7. TROUBLESHOOTING

Problem	Possible cause	Troubleshooting
Motor fails to develop full power (output of motor decreases rapidly with decrease in voltage at motor terminals).	<ol style="list-style-type: none"> 1. Power line overloaded with lights, appliances, and other motors. 2. Undersized wires or circuits too long. 	<ol style="list-style-type: none"> 1. Reduce load on power line. 2. Increase wire sizes or reduce length of the circuit.
Motor overheats.	<ol style="list-style-type: none"> 1. Motor thermal protector rejected 2. Air circulation through the motor restricted. 	<ol style="list-style-type: none"> 1. Wait for the motor temperature cold down; then motor thermal protector will re-set automatically 2. Clean out motor to provide normal air circulation.
Motor stalls (resulting in blown fuses or tripped circuit).	<ol style="list-style-type: none"> 1. Short circuit in motor or loose connections. 2. Low voltage. 3. Incorrect fuses or circuit breakers in power line. 4. Ampere setting too low, conductor overloaded. 	<ol style="list-style-type: none"> 1. Repair loose or shorted terminals, or worn insulation on motor. 2. Correct the low voltage conditions. 3. Install correct fuses or circuit breakers. 4. Reset the ampere value correctly by checking the machine information from the name plate.
Main blade runs backwards.	<ol style="list-style-type: none"> 1. Two of the power wires are reversed. 	<ol style="list-style-type: none"> 1. Exchange wires L1 & L3 in the terminal box.
Blade makes a squealing noise on start-up.	<ol style="list-style-type: none"> 1. Belt worn out. 	<ol style="list-style-type: none"> 1. Replace belt.
Workpiece jammed when feeding forward.	<ol style="list-style-type: none"> 1. Blunt saw blade. 2. Riving knife thickness does not match the saw blade used. 	<ol style="list-style-type: none"> 1. Fit a sharp saw blade 2. Fit the correct riving knife; it must thicker than the main saw blade (or at least the same) .
The finished size of the cut workpiece does not match the cutting width set on the rip fence.	<ol style="list-style-type: none"> 1. Dimension scale for cutting widths is misadjusted. 2. Incorrect scale position. 	<ol style="list-style-type: none"> 1. Reset the dimension scale to correct size. 2. Reset scale position. Cut a workpiece on the rip fence, precisely measure the cut width and position the scale to match workpiece size.

7. TROUBLESHOOTING

Problem	Possible cause	Troubleshooting
The finished size of the cut workpiece does not match the cutting width set on the crosscut stop.	<ol style="list-style-type: none"> 1. Dimension scale for cutting widths is misadjusted. 2. Incorrect fence position. 	<ol style="list-style-type: none"> 1. Reset the flip stop to correct size. 2. Cut a workpiece on the crosscut fence, precisely measure the cut width and reset crosscut fence position to match workpiece size.
Sliding table saw does not cut square.	<ol style="list-style-type: none"> 1. Sliding table is not parallel to blade. 2. Rip fence is not parallel to blade. 3. Crosscut fence is not perpendicular to the blade. 	<ol style="list-style-type: none"> 1. Adjust the sliding table. 2. Adjust the rip fence. 3. Adjust the crosscut fence perpendicular to the blade.
Saw blade burns on the sliding table side.	<ol style="list-style-type: none"> 1. Insufficient free cut on sliding table. 	<ol style="list-style-type: none"> 1. Readjust the free cut.
Saw blade burns on the rip fence side.	<ol style="list-style-type: none"> 1. Excessive free cut on the rip fence. 2. Insufficient free cut on rip fence. 	<ol style="list-style-type: none"> 1. Readjust the rip fence. 2. Readjust the free cut.
Saw blade burns on both sides.	<ol style="list-style-type: none"> 1. Incorrect free cut setting. 2. Cut material jammed. 3. Operating error. 	<ol style="list-style-type: none"> 1. Readjust the free cut 2. Insert a riving knife in the cutting line or use a wider riving knife 3. Either moves the workpiece to the left- or right-hand stop. Do not guide the workpiece on the rip fence when cutting with the sliding table
Workpiece has burn marks.	<ol style="list-style-type: none"> 1. Blunt saw blade. 2. Feed too low. 3. Saw blade has too many teeth. 4. Incorrect free cut. 	<ol style="list-style-type: none"> 1. Change the saw blade. 2. Increase the feed rate. 3. Change the saw blade. 4. Readjust the free cut.
Workpiece has burned edges, binds, or kicks back.	<ol style="list-style-type: none"> 1. Sliding table is not parallel to blade. 2. Riving knife is not aligned with the blade. 3. Blade is warped. 	<ol style="list-style-type: none"> 1. Make sliding table parallel to the blade . 2. Shim the riving knife to align it with the main blade. 3. Replace the blade.

7. TROUBLESHOOTING

Problem	Possible cause	Troubleshooting
Workpiece has chip out on the bottom edge.	<ol style="list-style-type: none"> 1. Scoring blade height is incorrect. 2. Scoring blade is not aligned with the main blade. 3. Scoring blade kerf does not match the main blade. 	<ol style="list-style-type: none"> 1. Adjust the height of the scoring blade. 2. Align the scoring blade. 3. Adjust the scoring blade kerf .
Workpiece chipped after cutting	<ol style="list-style-type: none"> 1. Scoring not aligned with main saw blade. 2. Scoring blade too narrow. 	<ol style="list-style-type: none"> 1. Readjust free cuts; the free cut should be almost "0". 2. Adjust saw width.
Workpiece rises when cut with the scoring.	<ol style="list-style-type: none"> 1. Blunt scoring blade . 2. Cutting height too low . 	<ol style="list-style-type: none"> 1. Exchange the sawing blade. 2. Set the scoring blade higher.
Loud repetitious noise coming from machine.	<ol style="list-style-type: none"> 1. Pulley setscrews or keys are missing or loose. 2. Motor fan is hitting the cover. 3. Belts are defective or damaged. 	<ol style="list-style-type: none"> 1. Inspect keys and setscrews. Replace or tighten if necessary. 2. Adjust fan cover mounting position, tighten fan, or shim fan cover. 3. Replace belts.
Vibration when running or cut-ting.	<ol style="list-style-type: none"> 1. Loose or damaged blade. 2. Worn arbor bearings. 3. Worn or damaged belts. 	<ol style="list-style-type: none"> 1. Tighten or replace blade. 2. Check/replace arbor bearings. 3. Replace belts.
Fence hits table top when sliding across table.	<ol style="list-style-type: none"> 1. Front rail is too low. 2. Rip fence roller is too low. 	<ol style="list-style-type: none"> 1. Raise the rail. 2. Adjust the roller.
The main blade speed is slow down abnormally	<ol style="list-style-type: none"> 1. Belt of the motor is not tighten 2. Locate Handle of the motor is loosen 	<ol style="list-style-type: none"> 1. Adjust the tightness of the Belt 2. Tighten the locate handle

1Ph,220V,60Hz,5HP+3/4HP,without brake

*electrical power supply:
1~,220V,60Hz
*recommend breaker capacity:
35A<fuse<40A,

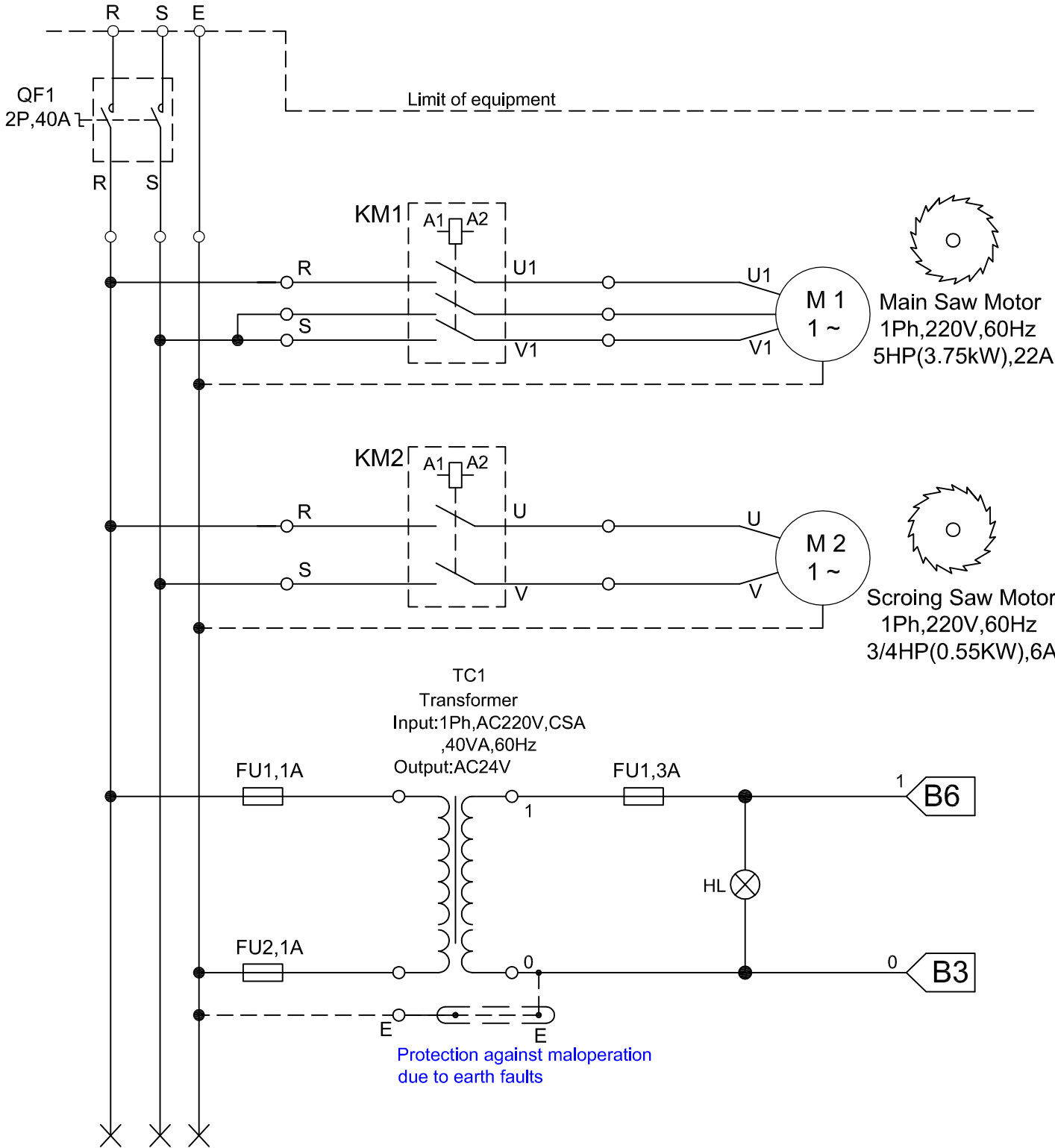

1Ph,220V,60Hz,5HP+3/4HP,without brake

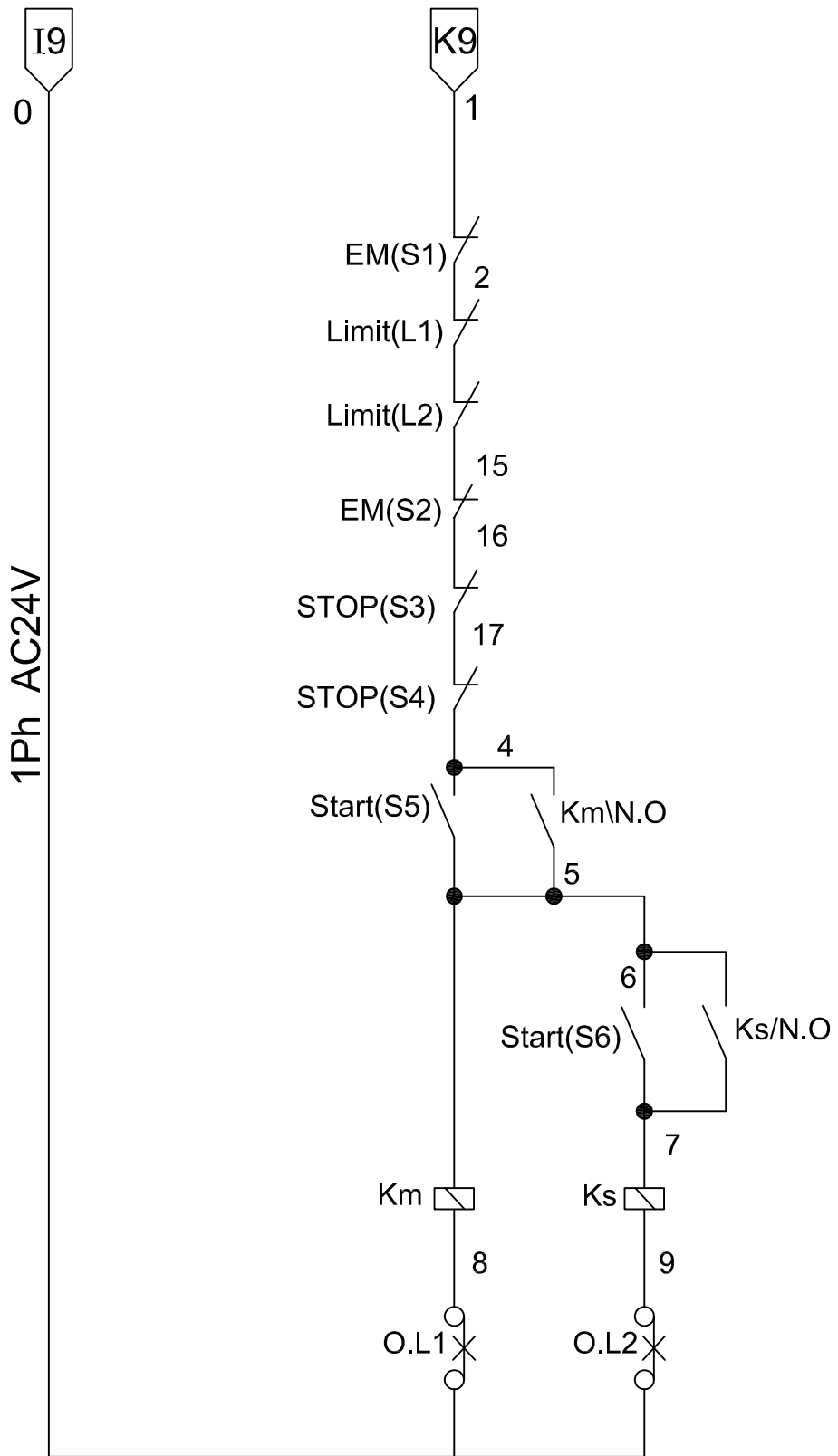

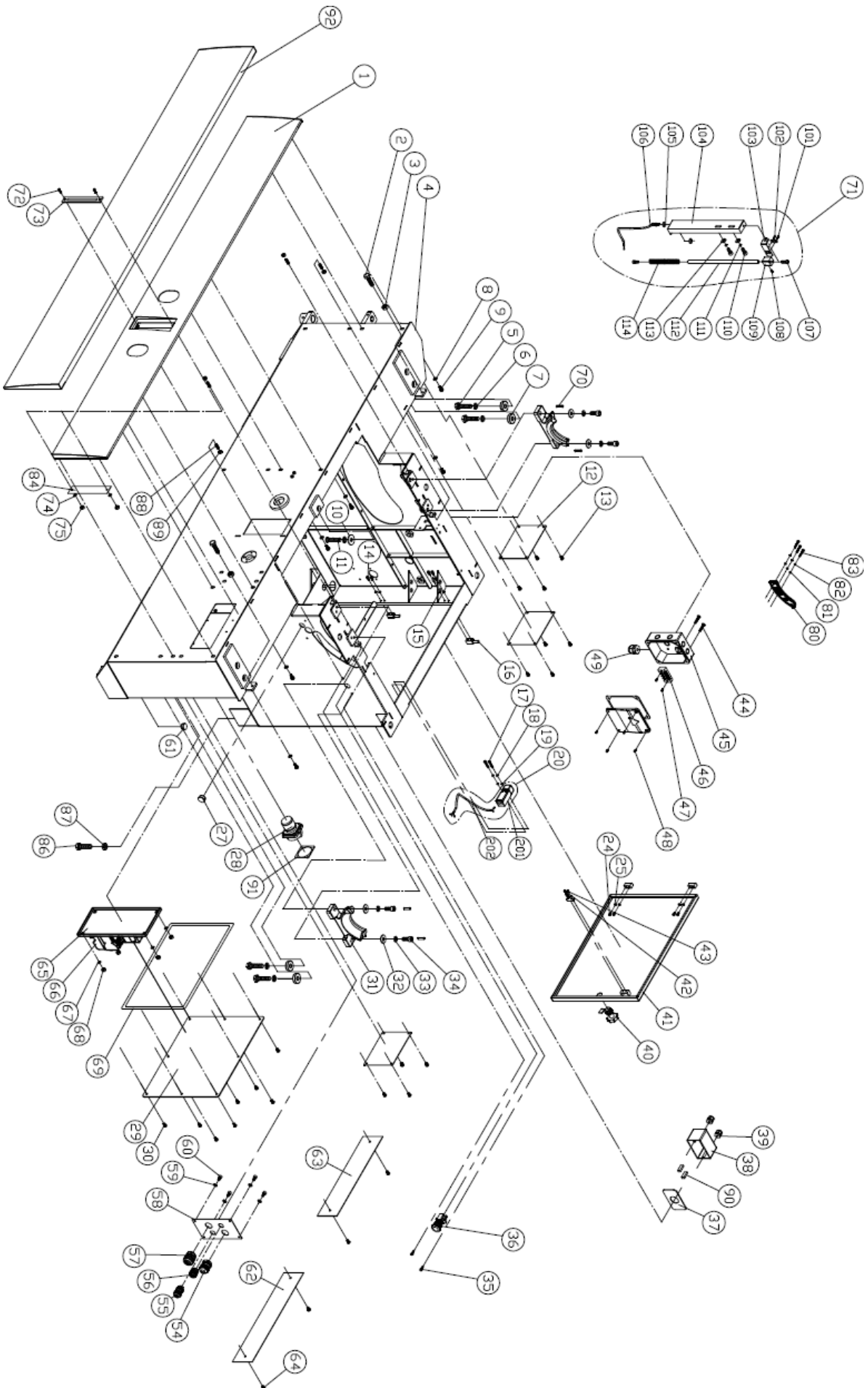

ITEM	PART NO	PART NAME	SIZE	Q`TY	NOTE
1	208100	Plate		1	RAL9011
2	SH100800	Hex Head Bolt	M10*40	2	
3	NH101700	Hex Nut	M10	2	
4	208095	Machine frame		1	RAL9011
5	SH121000	Hex Head Bolt	M12*50	4	
6	WS120000	Lock Washer	M12	5	
7	203410	Ring		4	
8	WS060000	Lock Washer	M6	14	
9	SR069400	Cap Screw	M6*16	14	
10	WF123025	Washer	M12* ψ 30	1	
11	SJ120900	Button Head Screw	M12*45	1	
12	207128	Plate		3	RAL9011
13	SJ069300	Button Head Screw	M6*12	12	
14	SR059300	Cap Screw	M5*12	4	
15	WS050000	Lock Washer	M5	4	
16	203412	Block		2	
17	SR040600	Cap Screw	M4*30	2	
18	WS040000	Lock Washer	M4	2	
19	WF040808	Washer	M4* ψ 8	2	
20	AB136458	Door Safety Switch ASM		1	
201	136457	Door Safety Switch	AZD-S11	1	
202	IC201413	Stop Cord	0.75x2Cx40CMx2Y2.E	1	
24	SR059200	Cap Screw	M5*8	4	
25	WS050000	Lock Washer	M5	4	
27	201458	Hole Plugs	HP-22	4	
28	994863	Power Switch	K-GN40-06	1	for 1PH/5HP
29	207129	Plate		1	RAL9011
30	SJ060200	Button Head Screw	M6x10	8	
31	207540	Base		2	X2
32	WF102030	Washer	M10* ψ 20	4	
33	WS100000	Lock Washer	M10	4	
34	SR100700	Cap Screw	M10*35	4	
35	ST050400	Tap Screw	M5*20	2	
36	994808	Emergency Stop Button	R2 PNR4-1B-R	1	
37	150956	Pad		1	
38	605408	Switch Box		1	
39	998621	Strain Relief		2	
40	203430	Lock		1	
41	205259	Door		1	RAL9011
42	WS040000	Lock Washer	M4	2	
43	SP049300	Pan Head Screw	M4*12	2	

ITEM	PART NO	PART NAME	SIZE	Q`TY	NOTE
44	SJ060400	Button Head Screw	M6*20	2	
45	201105	Power Box		1	CE
	201105A	Power Box		1	CSA
46	994805	Terminal	PB2504 4P	1	CE
	994805	Terminal	PB2504 4P	1	CSA
47	SP059200	Pan Head Screw	M5*8	2	
48	SJ059300	Button Head Screw	M5*12	4	
49	709421	Strain Relief	PG20	2	
54	203860	Strain Relief		1	
55	709421	Strain Relief	PG20	1	
56	998655	Strain Relief		1	
57	203889	Strain Relief		1	
58	208103	Plate		1	for T/LAG
59	WS060000	Lock Washer	M6	4	
60	SR069300	Cap Screw	M6*12	4	
61	201458	Hole Plugs	HP-22	1	
62	207299-32	Plate		1	RAL9011
63	207309-33	Plate		1	RAL9011
64	SF060200	Pan Head Screw(+)/W	M6*10	4	
65	200867A-1	Plate		1	without 2 stages
	200867A-2	Plate		1	with 2 stage
66	200867	Electric.Panel	400V 3~	1	
67	WF061310	Washer	M6x13	4	
68	NF061000	Hex Flange Nut	M6	4	
69	150527	Pad	2x300x7.5(M/M)	6	
70	PS062500	Spring Pin	ψ6*25	4	
71	AB207399	Steel Wire ASM		1	
101	WF051210	Washer	M5x12	2	
102	SP050200	Pan Head Screw	M5x10	2	
103	200840	Pointer		1	
104	200841	Fix Plate		1	
105	WF061310	Washer	M6x13	2	
106	207399	Steel Wire		1	
107	SR050200	Cap Screw	M5x10	2	
108	SS050200	Setscrew	M5x10	1	
109	200843	Indicator Block		1	
110	SR069300	Cap Screw	M6x12	2	
111	WS060000	Lock Washer	M6	2	
112	200842	Shaft		1	
113	WF061310	Washer	M6x13	2	
114	200993	Spring		1	

ITEM	PART NO	PART NAME	SIZE	Q`TY	NOTE
72	SP040400	Pan Head Screw/W	M4x20	2	
73	LM001076	Tilt Scale	acrylic	1	
74	WF040808	Washer	M4	2	
75	NF040700	Hex Nut	M4	2	
80	207303	Plate		1	
81	WF061920	Washer	M6x19x2t	3	
82	WS060000	Lock Washer	M6	3	
83	SR069400	Cap Screw	M6*16	3	
84	201785	Plate		1	
86	SH161100	Hex Head Bolt	M16x50	4	
87	NH162400	Hex Nut	M16	4	
88	SS080500	Set Screw	M8*25	4	
89	NH081300	Hex Nut	M8	4	
90	136019	Cord Connetor	224-201	2	
91	206623	Plate		1	for 1PH/5HP
92	205847	Plate		1	RAL9011

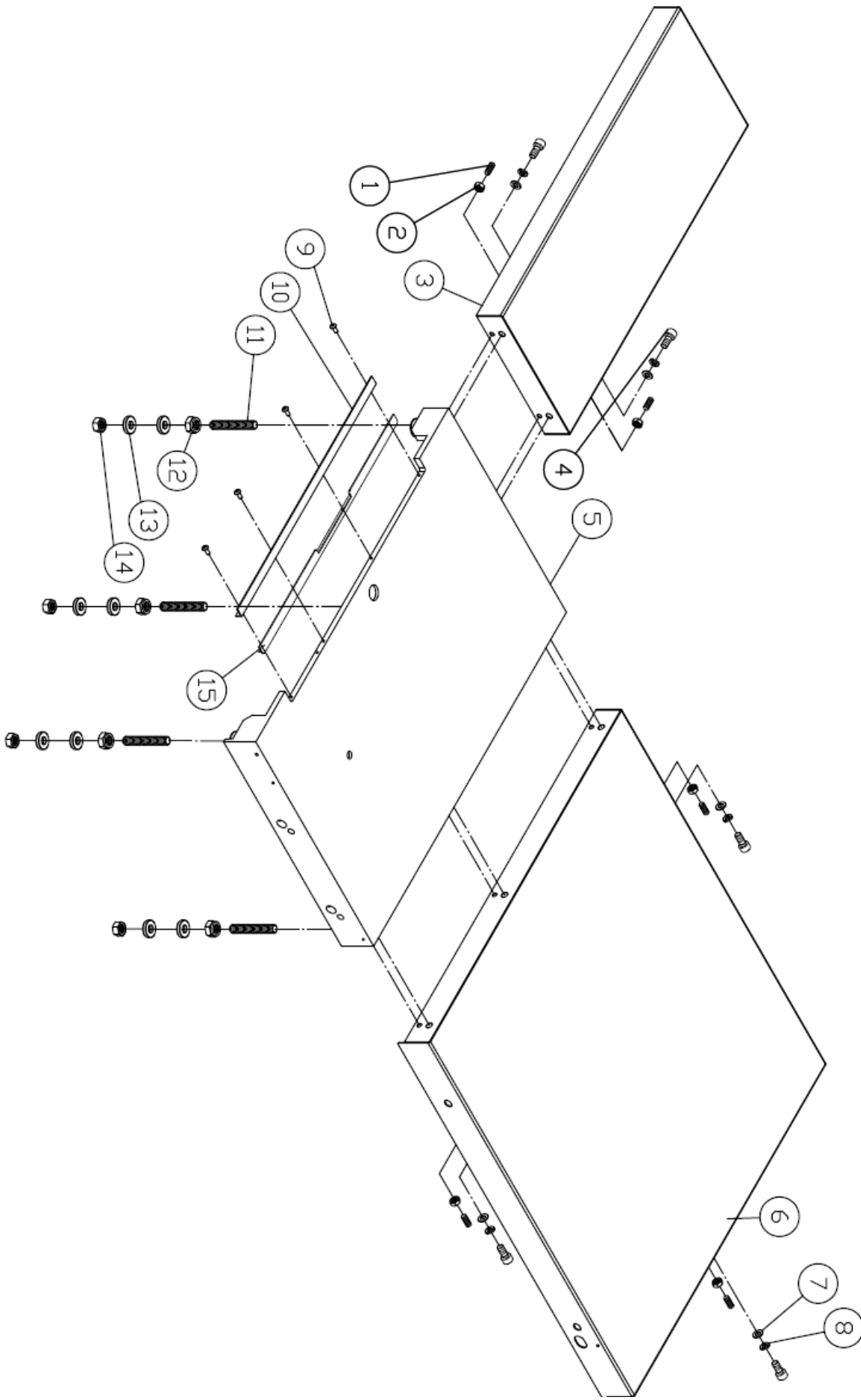

ITEM	PART NO	PART NAME	SIZE	Q`TY	NOTE
1	SS100400	Set Screw	M10*20	5	
2	NH101700	Hex Nut	M10	5	
3	207077	Left Ext. Plate		1	5655C
4	SR100500	Cap Screw	M10*25	5	
5	207733	Table		1	Z
6	207078	Ext. Plate		1	5655C
7	WF102030	Washer	M10* ψ 20	5	
8	WS100000	Lock Washer	M10	5	
9	SJ069300	Button Head Screw	M6*12	4	
10	206354	Table Insert	aluminum	1	
11	SS162000	Set Screw	M16*100	4	
12	NL162400	Lock Nut	M16	4	
13	205016	Washer		8	
14	NH162400	Hex Nut	M16	4	
15	207732	Table Insert	aluminum	1	Dado only

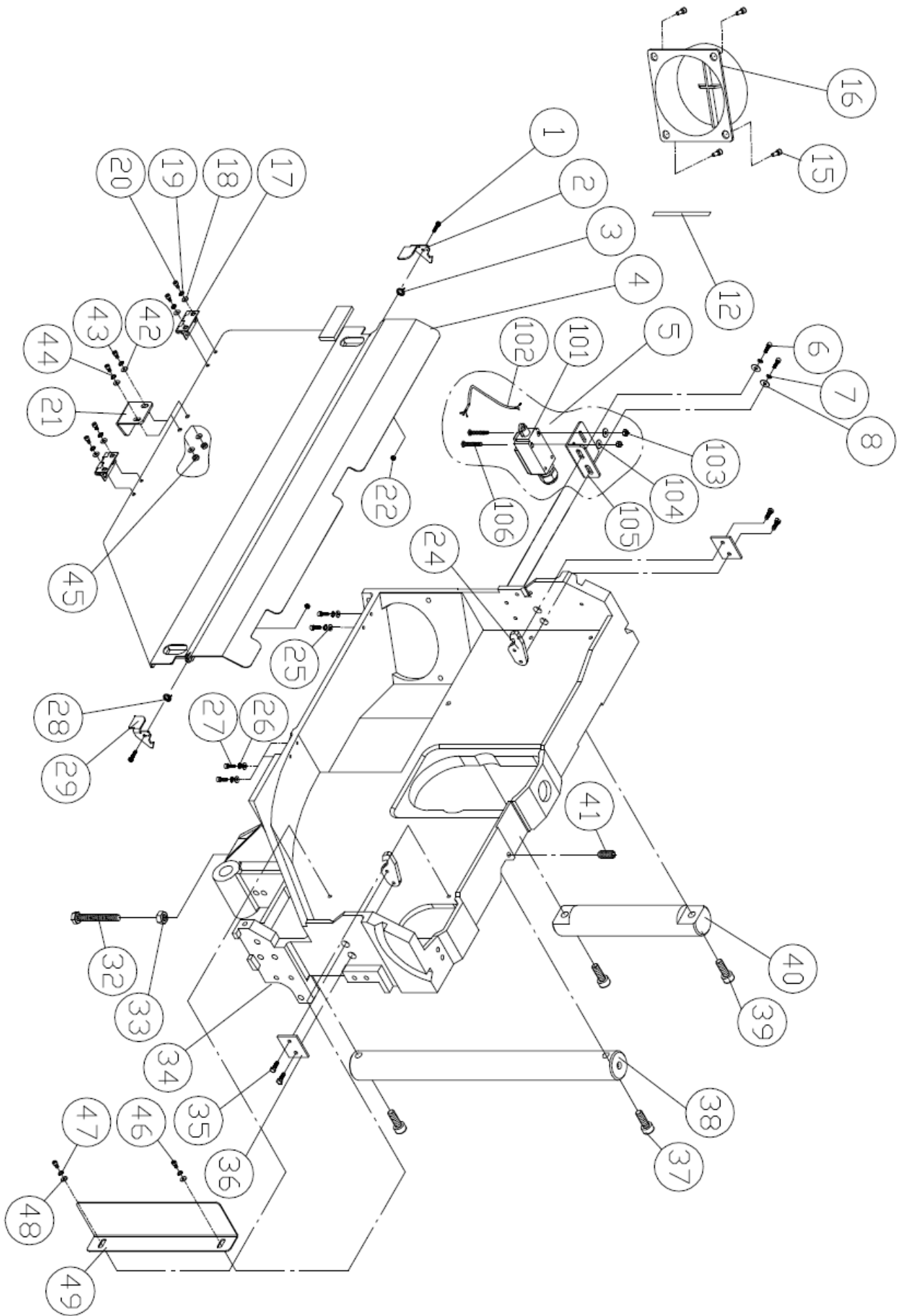

ITEM	PART NO	PART NAME	SIZE	Q`TY	NOTE
1	SR040600	Cap Screw	M4*30	2	
2	207055	Hook(L)		1	
3	207057	Spring		1	
4	208091	Cover		1	F1L
5	AB136013	Door Safety Switch ASM		1	
101	136012	Door Safety Switch		1	
102	IC207013	STOP CORD	0.75x2Cx2.5Mx3Y1	1	
103	NH040700	Hex Nut	M4	2	
104	WF040805	Washer	M4* ψ 8	2	
105	200853	Fix Plate		1	
106	SP040700	Pan Head Plate	M4*35	2	
6	SR060200	Cap Screw	M6*10	2	
7	WS060000	Lock Washer	M6	2	
8	WF061310	Washer	M6* ψ 13	2	
12	150527	Sponge		2	
15	SF089300	Hex Head Bolt(+)/W	M8x12	4	
16	206118	Dust Port		1	
17	207940	Hinge		2	
18	WF051010	Washer	M5*10	4	
19	WS050000	Lock Washer	M5	4	
20	SR059200	Cap Screw	M5*8	4	
21	207152	Plate		1	
22	NL040700	Lock Nut	M4	2	
24	207066	Hook		2	
25	WF051010	Washer	M5*10	4	
26	WS050000	Lock Washer	M5	4	
27	SR050200	Cap Screw	M5*10	4	
28	207057A	Spring		1	
29	207056	Hook(R)		1	
32	SH081000	Hex Head Bolt	M8*50	1	
33	NH081300	Hex Nut	M8	1	
34	208093	Channel Base		1	T
35	SH060400	Hex Head Bolt	M6*20	4	
36	207071	Plate		2	
37	SR080900	Cap Screw	M8*45	2	
38	207004	Shaft		1	
39	SR080900	Cap Screw	M8*45	2	
40	207005-1	Shaft		1	
41	SS080400	Setscrew	M8*20	1	
42	WF051010	Washer	M5*10	4	

ITEM	PART NO	PART NAME	SIZE	Q`TY	NOTE
43	SR059400	Cap Screw	M5*16	2	
44	WS050000	Lock Washer	M5	2	
45	NH050800	Hex Nut	M5	2	
46	SR060200	Cap Screw	M6*10	2	
47	WS060000	Lock Washer	M6	2	
48	WF061620	Washer	M6*ψ16	2	
49	207936	Plate		1	

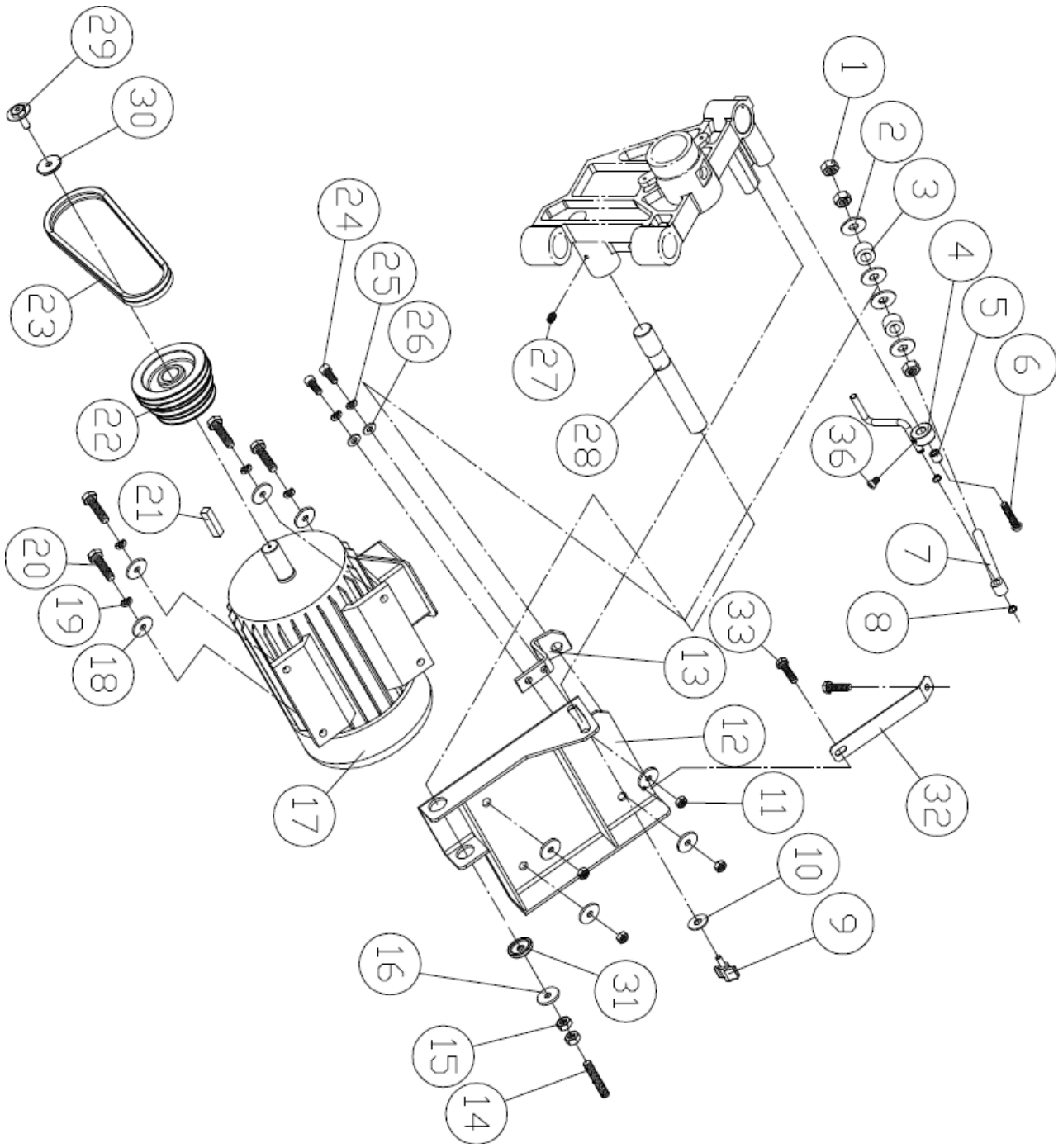

ITEM	PART NO	PART NAME	SIZE	Q`TY	NOTE
1	NH142200	Hex Nut	M14	3	
2	WF143530	Washer	M14* ψ 35	4	
3	207048	Pad		2	
4	207043	Adjusting Shaft		1	
5	200999	Bushing		1	
6	SJ080600	Button Head Screw	M8*30	1	
7	207046	Adjusting Screw		1	
8	RS100000	Retaining Ring	S10	2	
9	207156	Lock Knob		1	
10	WF083030	Washer	M8* ψ 30	1	
11	NH101700	Hex Nut	M10	4	
12	207138A	Motor Plate		1	Optional 3PH
	207951	Motor Plate		1	Optional 1PH
13	207042	Plate		1	
14	SS101100	Set Screw	M10*55	1	
15	NH101700	Hex Nut	M10	2	
16	WF104030	Washer	M10* ψ 40	1	
17	MH207003	Main Motor		1	
	MH207004	Main Motor	Y- Δ	1	Optional
18	WF104030	Washer	M10* ψ 40	8	
19	WS100000	Lock Washer	M10	4	
20	SH100800	Hex Head Bolt	M10*40	4	
21	KS080750	Key	8*7*50	1	
22	207053	Motor Pulley	50HZ	1	X2, CE
	207110	Motor Pulley	60HZ	1	CSA
23	207130	V-Belt	3VX-315	2	CE
	207141	V-Belt	3VX-300	2	CSA
24	SR080500	Cap Screw	M8*25	2	
25	WS080000	Lock Washer	M8	2	
26	WF081818	Washer	M8* ψ 18	2	
27	SS089300	Set Screw	M8*12	1	
28	207050	Shaft		1	
29	SG100400	Hex Head Cap Screw/W	M10*20	1	
30	WF104030	Washer	M10* ψ 40*3t	1	
31	207153	Washer		1	
32	207188	Plate		1	F1L
33	SF089300	Hex Head Bolt(+)/W	M8x12	2	
36	SR080200	Cap Screw	M8*10	1	

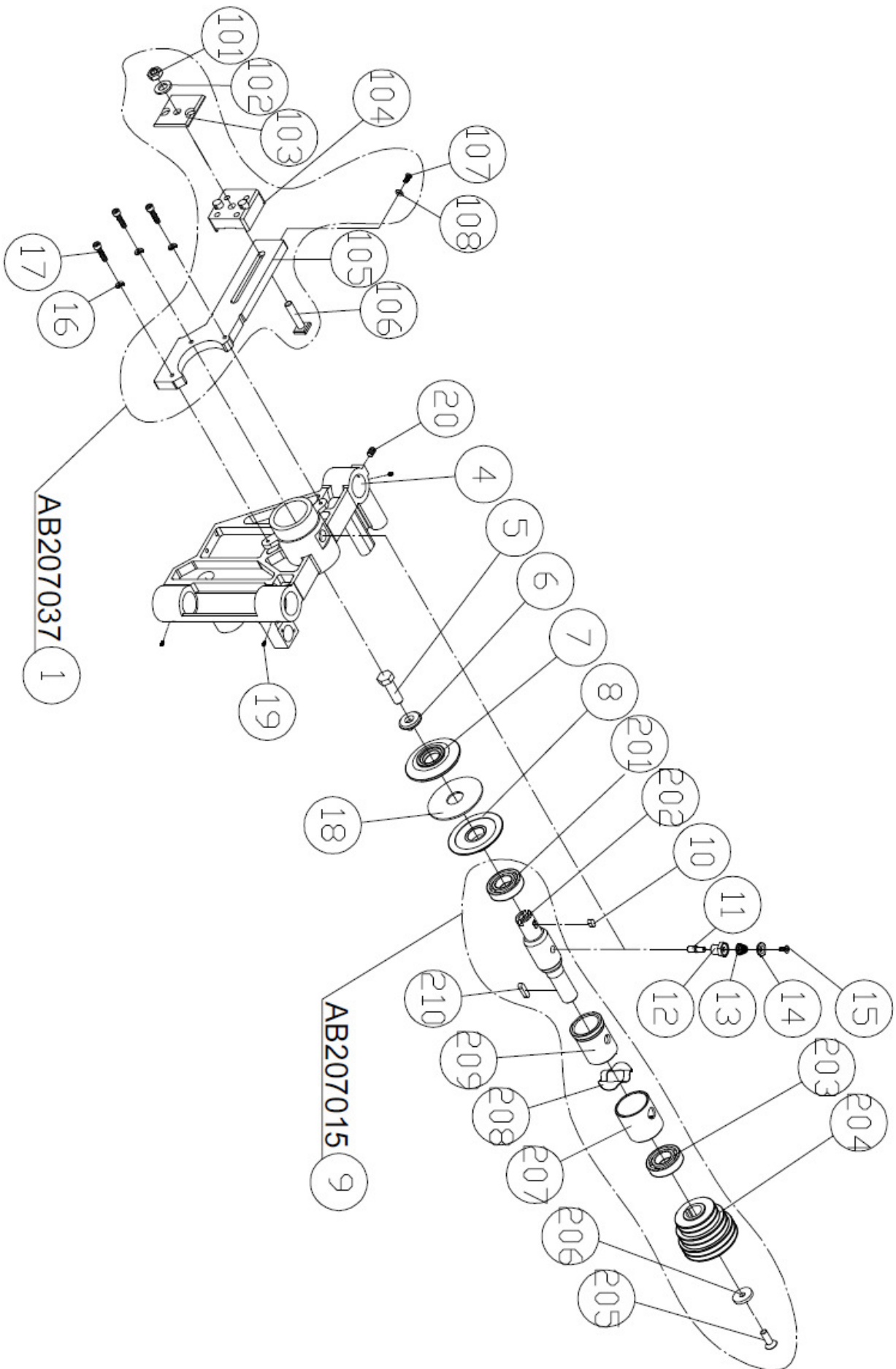

ITEM	PART NO	PART NAME	SIZE	Q`TY	NOTE
1	AB207037	Bracket Assembly		1	X2
101	NH121900	Hex Nut	M12*1.75	1	
102	WF163030	Washer	M16* ψ 30	1	
103	207030			1	
104	207040	Block		1	
105	207037	Bracket		1	X2
106	207031	Screw		1	
107	SJ069300	Button Head Screw	M6*12	1	
108	WF061920	Washer	M6* ψ 19	1	
4	207003	Bracket		1	
5	207019	Bolt	M16*2p(L)	1	
6	207012	Washer		1	
7	207014	Flange	ψ 30	1	
	207157	Flange	ψ 25.4	1	Optional
8	207013	Flange		1	
9	AB207015	Main Shaft Assembly	ψ 30	1	
201	BB620604	Ball Bearing	6206LLB(black)	1	
202	207015	Main Shaft	ψ 30	1	
	207158	Main Shaft	ψ 25.4	1	Optional
203	BB620604	Ball Bearing	6206LLB(black)	1	
204	207020	Pulley		1	X2
205	SI100500	Counter Sunk Screw	M10*25	1	
206	205035	Washer		1	
207	207016	Ring		1	
208	WW425203	Wave Washer	ψ 42* ψ 52 t=0.3 (6205)	1	
209	207017	Ring		1	
210	KD080730	Key	8*7*30	1	
10	KD080715	Key	8*7*15	1	
11	207009	Shaft		1	
12	207010	Block		1	
13	207011	Cone Spring		1	
14	207008	Washer		1	
15	SI059300	Counter Sunk Screw	M5*12	1	
16	WS060000	Lock Washer	M6	3	
17	SR060500	Cap Screw	M6*25	3	
18	207144	Washer		1	F1L
19	203198	Oil Filler Point		3	
20	SS080200	Setscrew	M8*10	1	

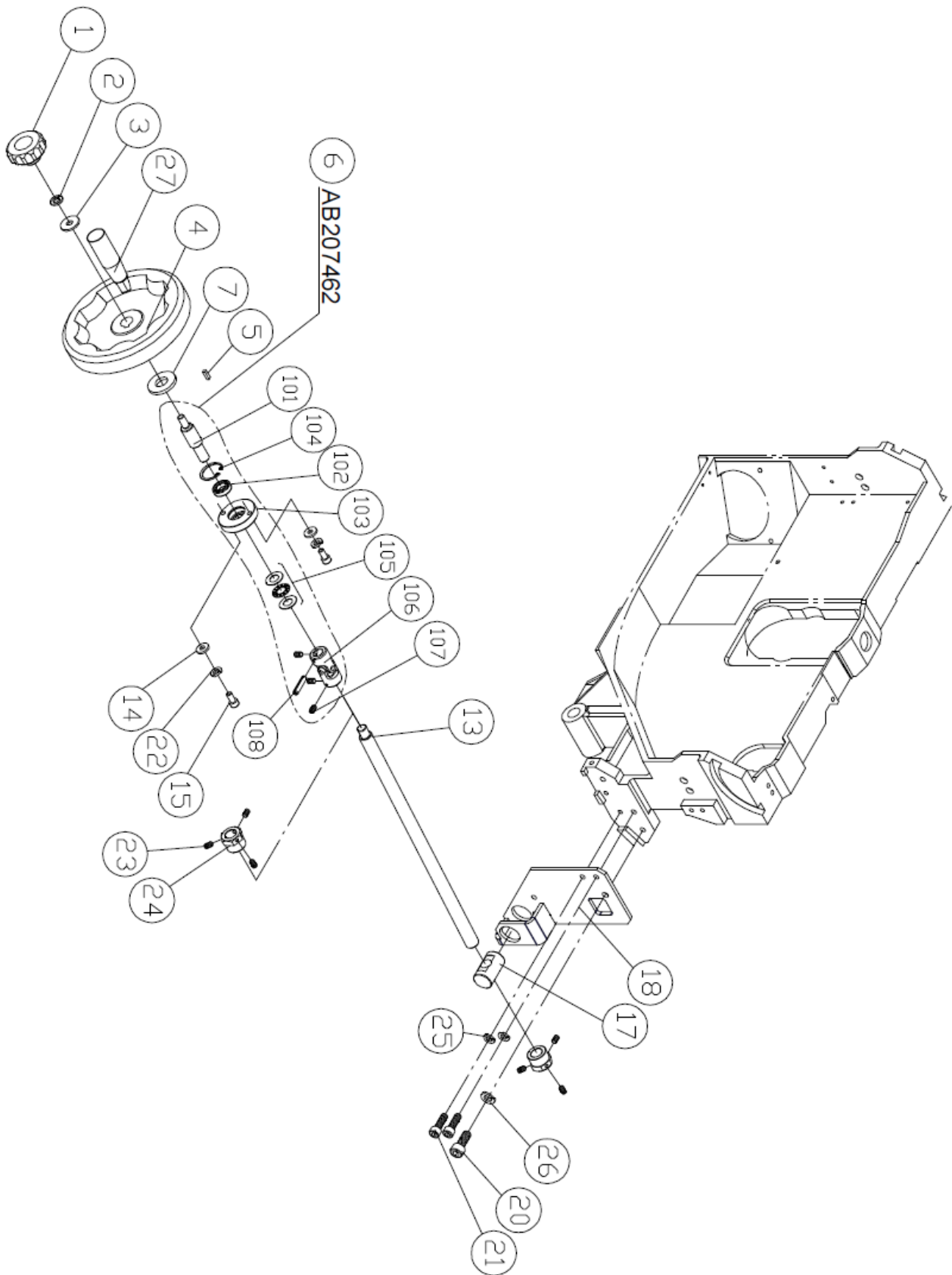

ITEM	PART NO	PART NAME	SIZE	Q`TY	NOTE
1	100203	Lock Knob	M10	1	
2	204263	Washer	$\psi 10 \times \psi 20$	1	
3	WF102730	Washer	M10 \times $\psi 27$ (for plastic hand wheel)	1	Standard
	WF104030	Washer	M10 \times $\psi 40$ (for cast iron hand wheel)	1	Optional
4	206434A	hand wheel	8"(plastic)	1	Standard
	200866	hand wheel	8"(cast iron)	1	Optional
5	KS070720	Key	7x7x20	1	
6	AB207462	Hand Wheel Shaft Assembly		1	
101	207462	Hand Wheel Shaft		1	
102	BB690202	Bearing	6902ZZ	1	
103	207252	Locate Ring		1	
104	RR280010	Ext. Retaining Ring	R28	1	
105	994204	Thrust Bearing	NTB1528+AS	1	
106	207461	Free Joint		1	
107	SS069100	Set Screw	M6 \times 6	3	
108	PS062600	Spring Pin	$\psi 6 \times \psi 26$	1	
7	201567	Washer	T5	1	
13	207393	Screw		1	
14	WF081818	Lock Washer	M8 \times $\psi 18$	2	
15	SR080500	Cap Screw	M8 \times 25	2	
17	207401A	Shaft	cast iron	1	
18	207403	Locate Block		1	
20	SR100400	Cap Screw	M10 \times 20	1	
21	SR080400	Cap Screw	M8 \times 20	2	
22	WS080000	Lock Washer	M8	2	
23	SS069100	Set Screw	M6 \times 6	6	
24	207400	Set Nut		2	
25	WS080000	Lock Washer	M8	2	
26	WS100000	Lock Washer	M10	1	
27	200866-1	Handle	folding handle	1	Standard

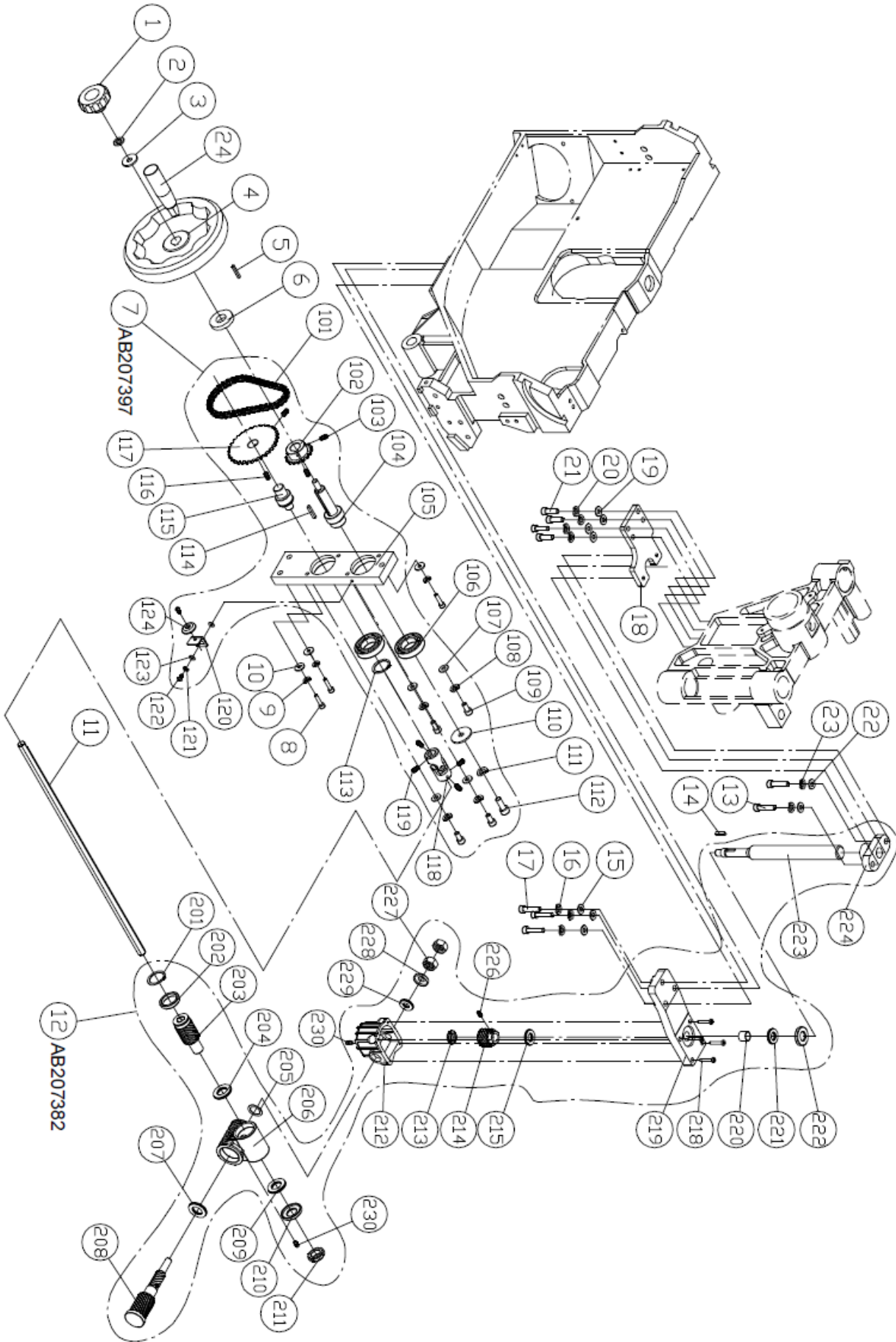

ITEM	PART NO	PART NAME	SIZE	Q`TY	NOTE
1	100203	Lock Knob	M10	1	
2	204263	Washer	$\psi 10 \times \psi 20$	1	
3	WF102730	Washer	M10 \times $\psi 27$ (for plastic hand wheel)	1	Standard
	WF104030	Washer	M10 \times $\psi 40$ (for cast iron hand wheel)	1	Optional
4	206434A	hand wheel	8"(plastic)	1	Standard
	200866	hand wheel	8"(cast iron)	1	Optional
5	KS070720	Key	7x7x20	1	
6	207450	Washer		1	
7	AB207397	Bearing Bracket ASM		1	
101	207396	Chain		1	
102	207115	Sprocket		1	
103	SS060200	Set Screw	M6 \times 10	2	
104	207279	Shaft		1	
105	207397	Bearing Bracket		1	
106	BB600602A	Bearing	6006ZZ	2	
107	WF081818	Washer	M8 \times $\psi 18$	4	
108	WS080000	Lock Washer	M8	4	
109	SR080400	Cap Screw	M8*20	4	
110	WF104030	Washer	M10 \times $\psi 40$	1	
111	WS100000	Lock Washer	M10	1	
112	SR100400	Cap Screw	M10*20	1	
113	RS300000	Ext. Retaining Ring	S30	1	
114	KS070715	Key	7x7x15	1	
115	207274	Shaft		1	
116	SS069200	Set Screw	M6 \times 8	2	
117	207385	Sprocket		1	
118	207461	Free Joint		1	
119	SS069100	Set Screw	M6 \times 6	4	
120	207833	Locate Plate		1	
121	WS060000	Lock Washer	M6	1	
122	SJ069300	Button Head Screw	M6*12	2	
123	WF061620	Washer	M6 \times $\psi 16$	2	
124	010341	Plastic Bearing		1	
8	SR060700	Cap Screw	M6*35	3	
9	WS060000	Lock Washer	M6	3	
10	WF061920	Washer	M6 \times $\psi 19$	3	
11	207277	Bar		1	
12	AB207382	Worm Gear(R) ASM		1	
201	RS300010	Ext. Retaining Ring	IS30	1	

ITEM	PART NO	PART NAME	SIZE	Q`TY	NOTE
202	207095	Ring		1	
203	207097	Worm Gear(L)		1	
204	994203	Thrust Bearing	NTB2035+AS	1	
205	205013	Washer		1	
206	207098	Cover Bracket		1	
207	994203	Thrust Bearing	NTB2035+AS	1	
208	207379	Worm Shaft		1	
209	994203	Thrust Bearing	NTB2035+AS	1	
210	207060	Cover		1	
211	205011	Nut	M20*1p	1	
212	207099	Cover		1	
213	203163	Nut	M15*1p	1	
214	207382	Worm Gear(R)		1	
215	994204	Thrust Bearing	NTB1528+AS	1	
218	ST551300	Tapping screw	3/16" X 1-3/8"	4	
219	207827	Bracket		1	
220	994351	Bushing Bearing	DU1515	1	
221	994206	Thrust Bearing	NTB1730+AS	1	
222	207381	Cover		1	
223	207093	Screw		1	
224	207090	Bracket		1	
226	SS050100	Set Screw	M5x5	1	
227	NH121900	Nut	M12	2	
228	207380	Cover		1	
229	994205	Thrust Bearing	NTB1226+AS	1	
230	203198	Oil Filler Point		2	
13	SR080600	Cap Screw	M8*30	2	
14	KD050520	Key	5x5x20	1	
15	WF081818	Washer	M8xψ18	3	
16	WS080000	Lock Washer	M8	3	
17	SR080800	Cap Screw	M8*40	3	
18	207109	Locate Plate		1	
19	WF081818	Washer	M8xψ18	4	
20	WS080000	Lock Washer	M8	4	
21	SR080500	Cap Screw	M8*25	4	
22	WF081818	Washer	M8xψ18	2	
23	WS080000	Lock Washer	M8	2	
24	200866-1	Handle	Folding handle	1	Standard

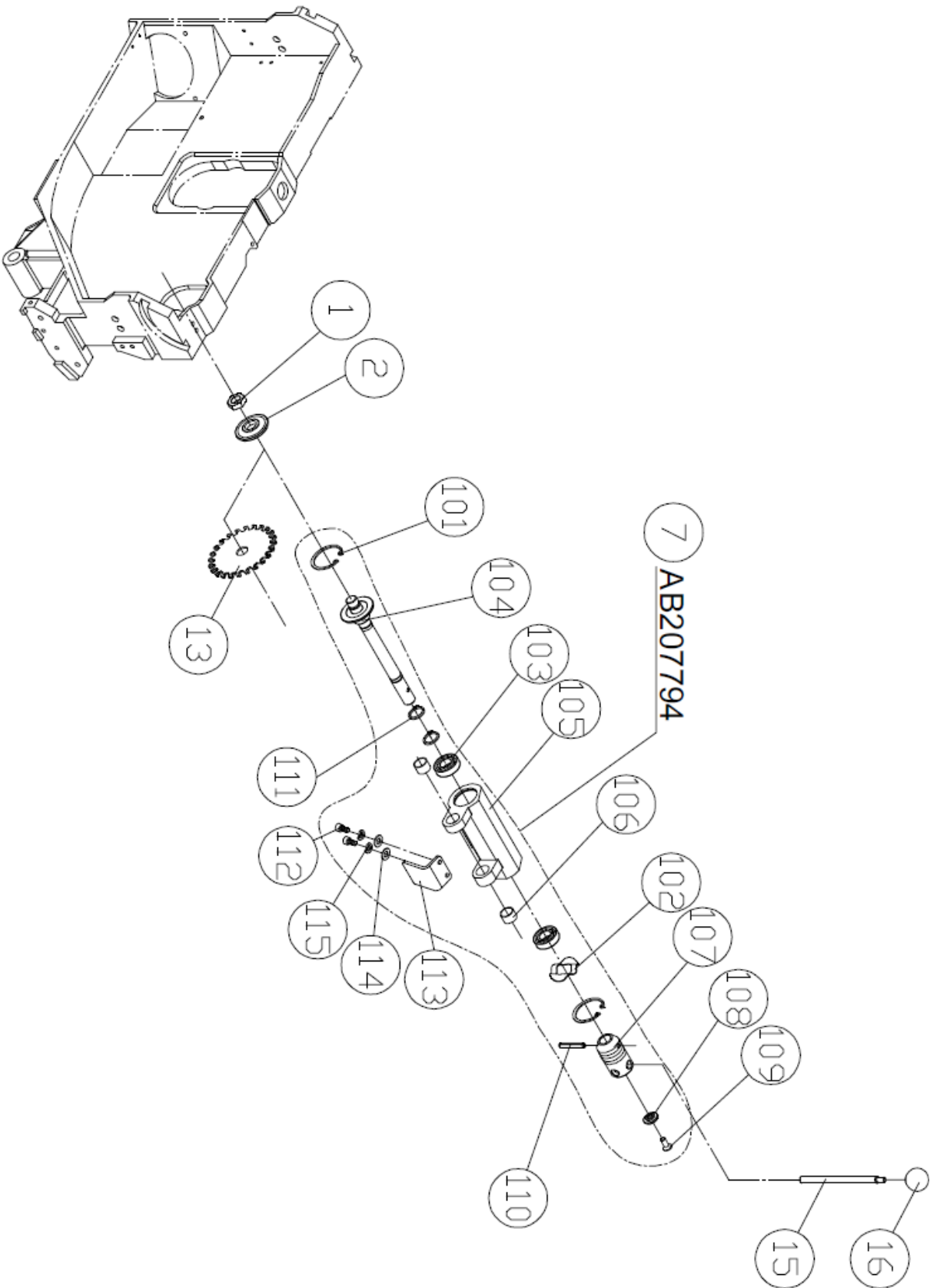

ITEM	PART NO	PART NAME	SIZE	Q`TY	NOTE
1	207024	Hex Nut	M18*1.5p	1	
2	207796	Flange		1	
7	AB207794	Shaft Assembly		1	
101	RR420000	Int. Retaining Ring	R42	2	
102	WW304003	Wave Washer	ψ30.1*ψ40.6 t=0.3 (6302)	3	
103	BB600404	Ball Bearing	6004LLB(Black)	2	
104	207794	Shaft		1	
105	207022	Bracket		1	
106	994352	Bushing Bearing	DU2015	2	
107	207232	Pulley		1	
108	203035	Washer		1	
109	SI080500	Counter Sunk Screw	M8*25	1	
110	PS064000	Spring Pin	ψ6*40	1	
111	RS200000	Retaining Ring	S20	2	
112	SR069400	Cap Screw	M6*16	2	
113	207036	Block		1	
114	WF061310	Washer	M6*ψ13	2	
115	WS060000	Lock Washer	M6	2	
13	200973	Scoring Saw Blade	φ20	1	Standard
	201937	Scoring Saw Blade	120mm(φ20)	1	Optional
15	205088	Rod		1	
16	100271	Ball Knob	M8*1.25P	1	

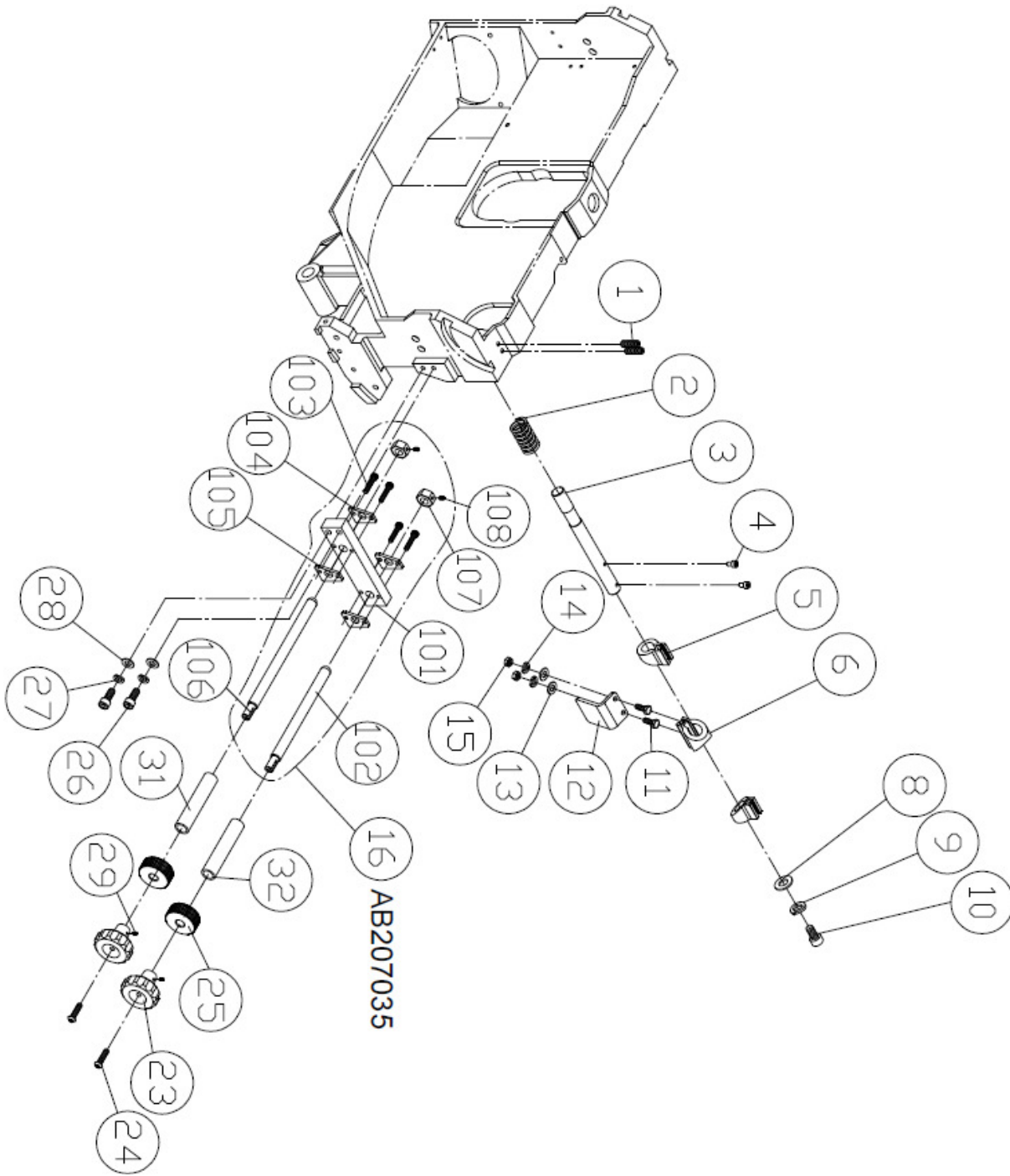

ITEM	PART NO	PART NAME	SIZE	Q`TY	NOTE
1	SS080400	Setscrew	M8x20	2	
2	207041	Spring		1	
3	207032	Shaft		1	
4	SR060200	Cap Screw	M6*10	2	
5	207033	Ring		2	
6	207034	Ring		1	
8	WF083030	Washer	M8* ψ 30	1	
9	WS080000	Lock Washer	M8	1	
10	SR089400	Cap Screw	M8*16	1	
11	SH069400	Hex Head Bolt	M6*16	2	
12	207036A	Block		1	
13	WF061310	Washer	M6* ψ 13	2	
14	WS060000	Lock Washer	M6	2	
15	NH061000	Hex Nut	M6	2	
16	AB207035	Block ASM		1	
101	207035	Block		1	
102	207038	Screw Threads		1	
103	SR050700	Cap Screw	M5*35	4	
104	207133-B	Plate		2	
105	207133-A	Plate		2	
106	207047	Screw Threads		1	
107	207135	Hex Nut		2	
108	SS060100	Setscrew	M6*5	2	
23	201868	adjust Knob		2	
24	SJ060600	Button Head Screw	M6*30	2	
25	207044	Hex Nut		2	
26	SR080700	Cap Screw	M8*35	2	
27	WS080000	Lock Washer	M8	2	
28	WF081818	Washer	M8* ψ 18	2	
29	SS050200	Setscrew	M5*10	2	
31	207039A	Bushing		1	
32	207039	Bushing		1	

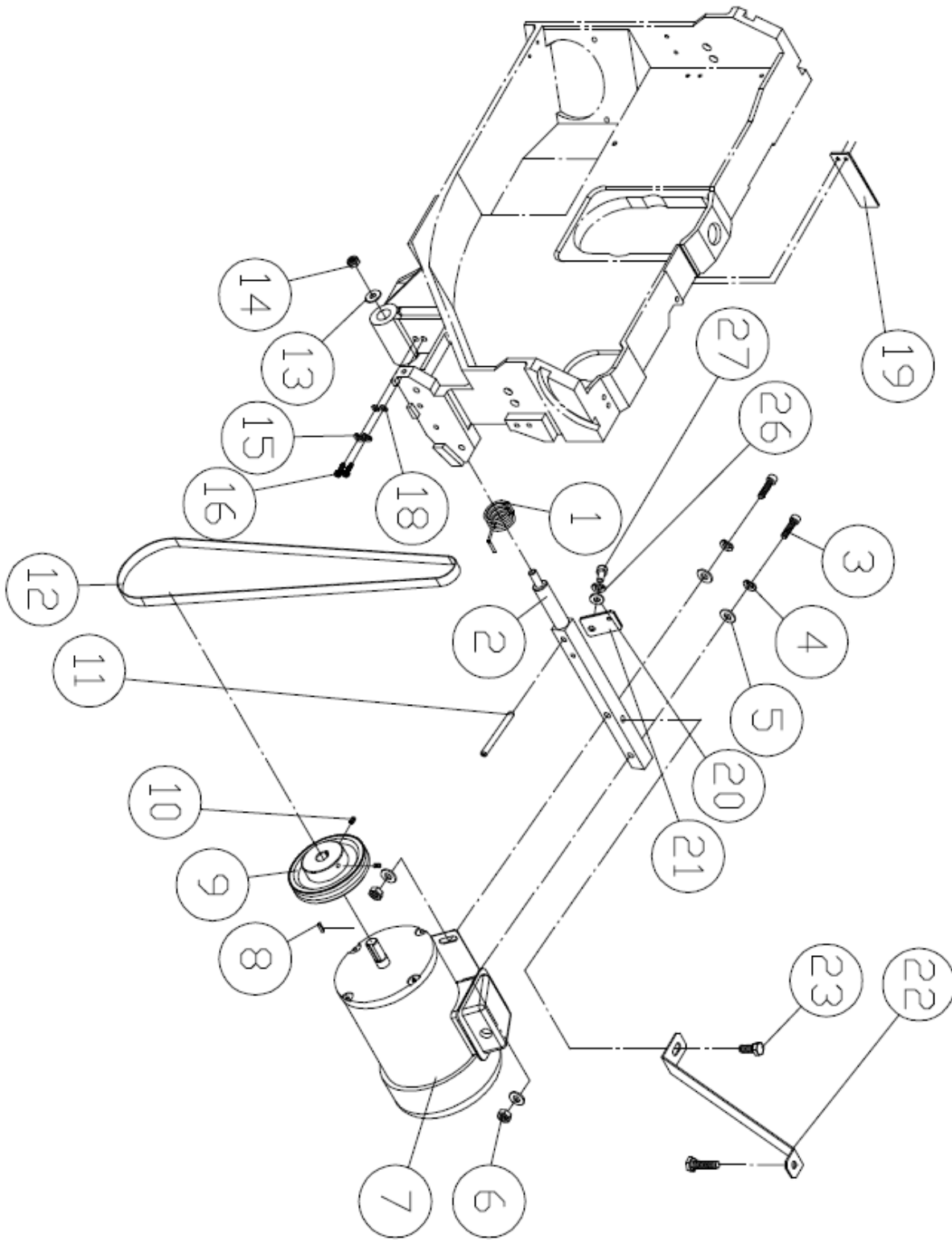

ITEM	PART NO	PART NAME	SIZE	Q`TY	NOTE
1	207072	Spring		1	
2	207052	Fix Pole		1	
3	SR080900	Cap Screw	M8*45	2	
4	WS080000	Lock Washer	M8	2	
5	WF081818	Washer	M8*ψ18	4	
6	NH081300	Hex Nut	M8	2	
7	MH207002	Motor		1	
8	KS050530	Key	5*5*30	1	
9	201028	Pulley	50HZ	1	CE
	201029	Pulley	60HZ	1	CSA
10	SS060400	Setscrew	M6*20	2	
11	PS087500	Spring pin	ψ8X75L	1	
12	LF420010	Belt	15W*1085L(50HZ)	1	CE
	LF410010	Belt	15W*1050L(60HZ)	1	CSA
13	WF104030	Washer	M10*ψ40	1	
14	NL101700	Lock Nut	M10	1	
15	WS080000	Lock Washer	M6	2	
16	SR060400	Cap Screw	M6*20	2	
18	WF061620	Washer	M6*ψ16	2	
19	207230	Stop Plate		1	
20	WF081818	Washer	M8*ψ18	1	
21	207765	Plate		1	
22	207189	Plate		1	F1L
23	SF089300	Hex Head Bolt(+)/W	M8x12	2	
26	WS080000	Lock Washer	M8	1	
27	SR089300	Cap Screw	M8*12	1	

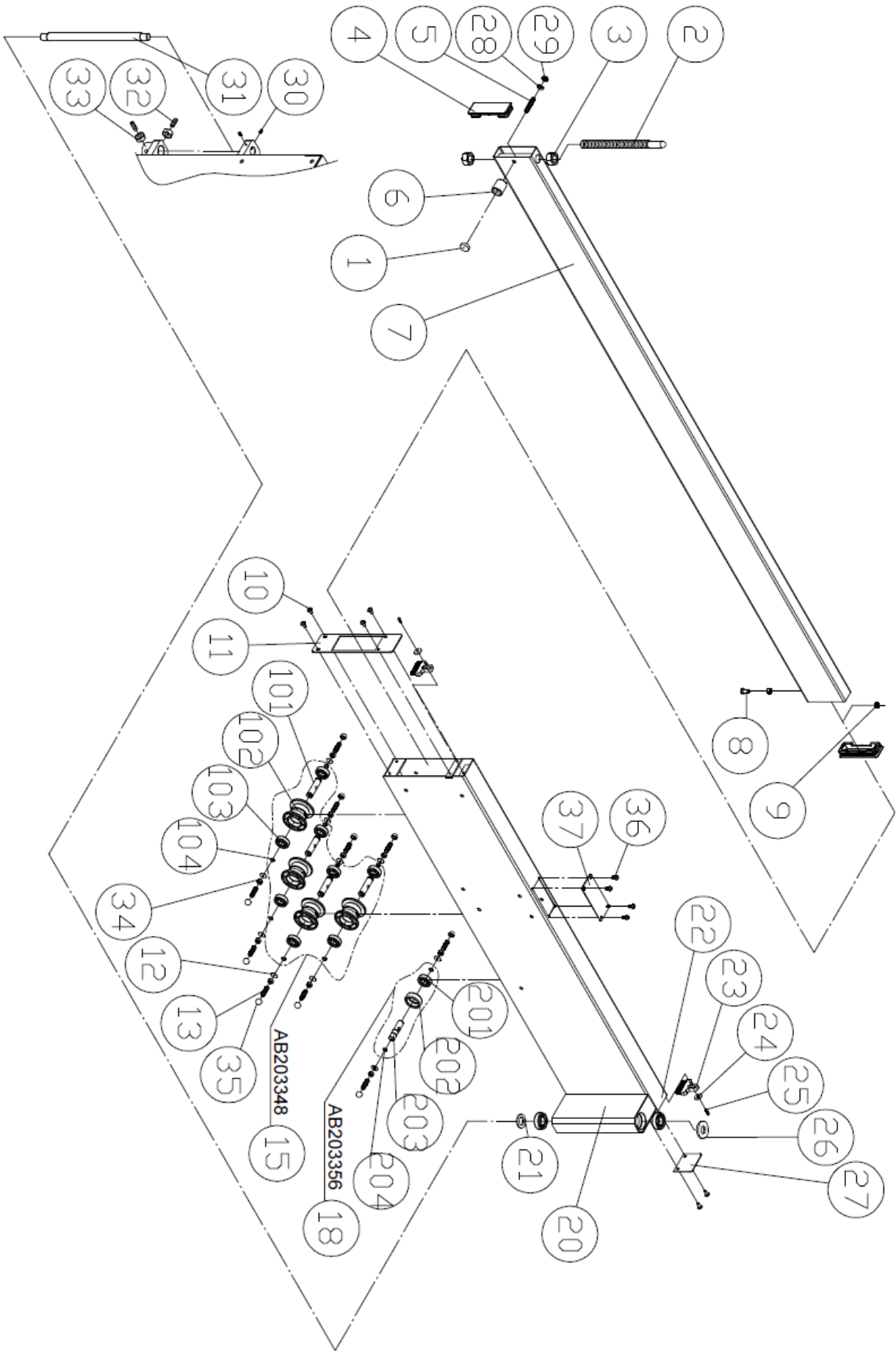

ITEM	PART NO	PART NAME	SIZE	Q`TY	NOTE
1	200934-2	Magnet		1	
2	205505B	Screw Threads		1	
3	NH203000	Hex Nut	M20x2.5p	2	
4	203470	Plug	40*120	2	
5	SS080700	Set Screw	M8*35	1	
6	201146-1	Magnetic Bracket		1	
7	205208	Sliding Tube		1	T
8	SH080400	Hex Head Screw	M8*20	1	
9	NH081300	Hex Nut	M8	2	
10	SJ060200	Button Head Screw	M6*10	6	
11	207085	Cover		1	GK
12	WF081818	Washer	M8* ψ 18	10	
13	SS080500	Setscrew	M8*25	10	
15	AB203348	Roller Assembly		4	
101	203349	Shaft		1	
102	203348	Roller		1	
103	BB620202	Bearing	6202ZZ	2	
104	RS150000	Ext. Retaining Ring	S15	2	
18	AB203356	Ring Assembly		1	
201	BB620202	Bearing	6202ZZ	1	
202	203356	Ring		1	
203	203357	Shaft		1	
204	RS150000	Ext. Retaining Ring	S15	2	
20	206421	Swing Arm		1	GK
21	WF203730	Washer	M20* ψ 37	1	
22	BB600402A	Bearing	6004ZZ	1	
23	135051-A	Brush		2	
24	WF061310	Washer	M6*13	2	
25	SR060400	Cap Screw	M6*20	2	
26	WF203730	Washer	M20* ψ 37	1	
27	207084	Plate		1	GK
28	WS080000	Spring Washer	M8	1	
29	203239	Hex Nut	M8*1.25P	1	
30	SS100200	Setscrew	M10*10	3	
31	207081	Shaft		1	
32	SS100400	Setscrew	M10*20	4	
33	NH101700	Hex Nut	M10	4	
34	NH081300	Hex Nut	M8	10	
35	207582	Cover	13mm	10	
36	SJ059200	Button Head Screw	M5*8	4	
37	207528	Plate		1	GK

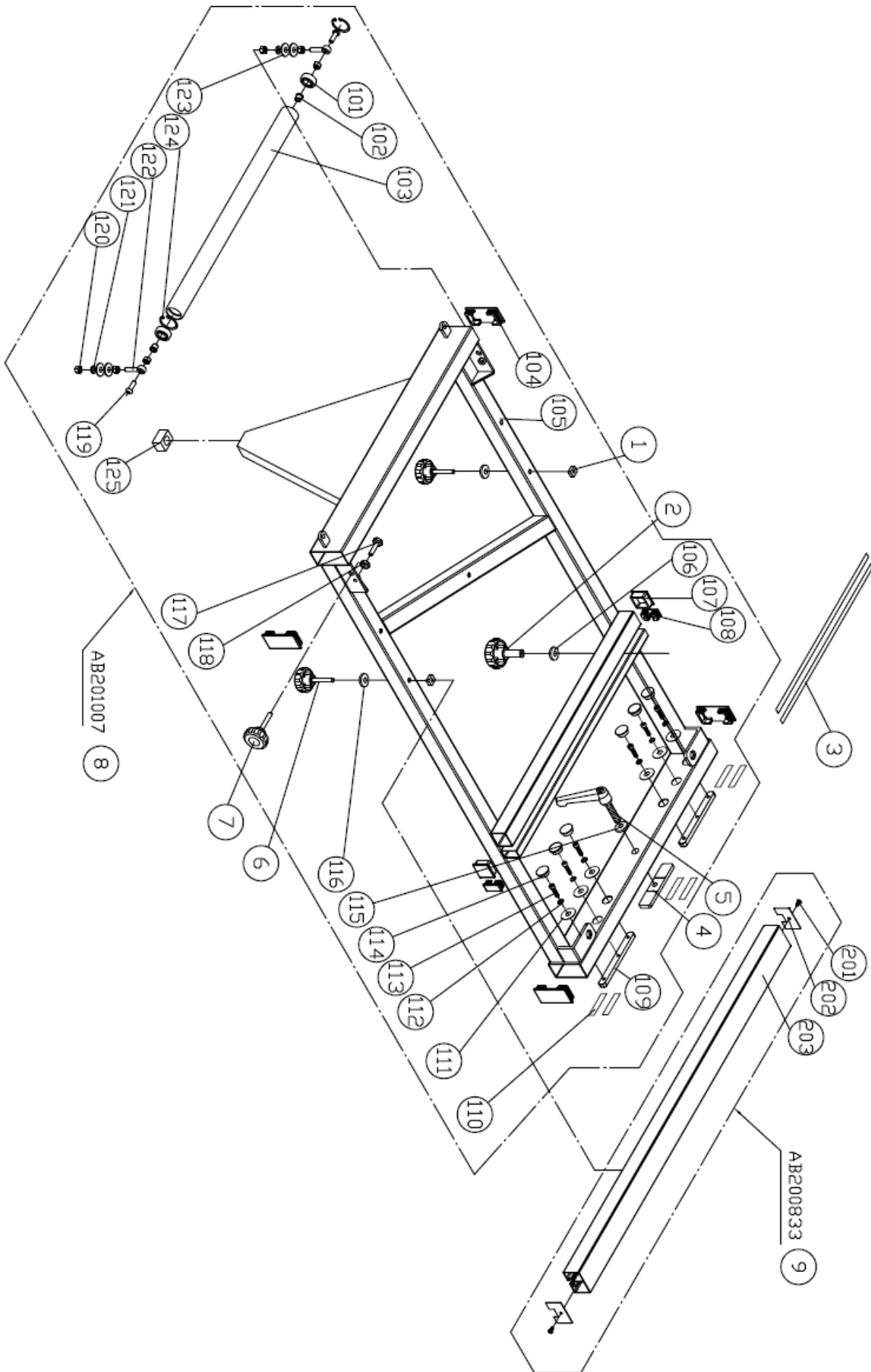

ITEM	PART NO	PART NAME	SIZE	Q`TY	NOTE
1	201103	T-Nut	M8x1.25p	2	
2	200952	Knob Screw	M8x1.25px25	1	
3	LM207005	Ruler		1	
4	201456	T-Block		1	
5	200815	Adjust Handle	M12x1.75px57L	1	
6	200954	Knob Screw	M8x50	2	
7	200954	Knob Screw	M8x50	1	
8	AB201007R	Support Frame ASM		1	A
101	BB620102A	Bearing	6201ZZ	2	
102	017058	Bearing		2	
103	203302	Roller		1	
104	200910	Plug	80x40	4	
105	201007	Support Frame		1	R
106	WF083030	Washer	M8x30	1	
107	200969	Plug	38x38	2	
108	200919	Plug	40x20	2	
109	201452	Plate		2	
110	201038	Pad	55mm	6	
111	WF061620	Washer	M6x16	6	
112	WS060000	Lock Washer	M6	6	
113	SJ069400	Button Head Screw	M6x16	6	
114	201458	Plug		6	
115	WF123030	Washer	M12	1	
116	WF083030	Washer	M8	2	
117	SH080600	Hex Head Screw	M8x30	2	
118	NH081300	Hex Nut	M8	2	
119	SJ080500	Button Head Screw	M8x25	2	
120	NH081300	Hex Nut	M8	6	
121	WS080000	Lock Washer	M8	2	
122	201542	Eye Bolts	M8x40	2	
123	WF081818	Washer	M8x18	4	
124	RR320000	Int. Retaining Ring	R32	2	
125	203094	Plug		1	
9	AB200833	Square Brace		1	A
201	ST040200	Tap Screw	#8x3/8"	2	
202	200955	Cover		2	
203	200833	Square Brace		1	

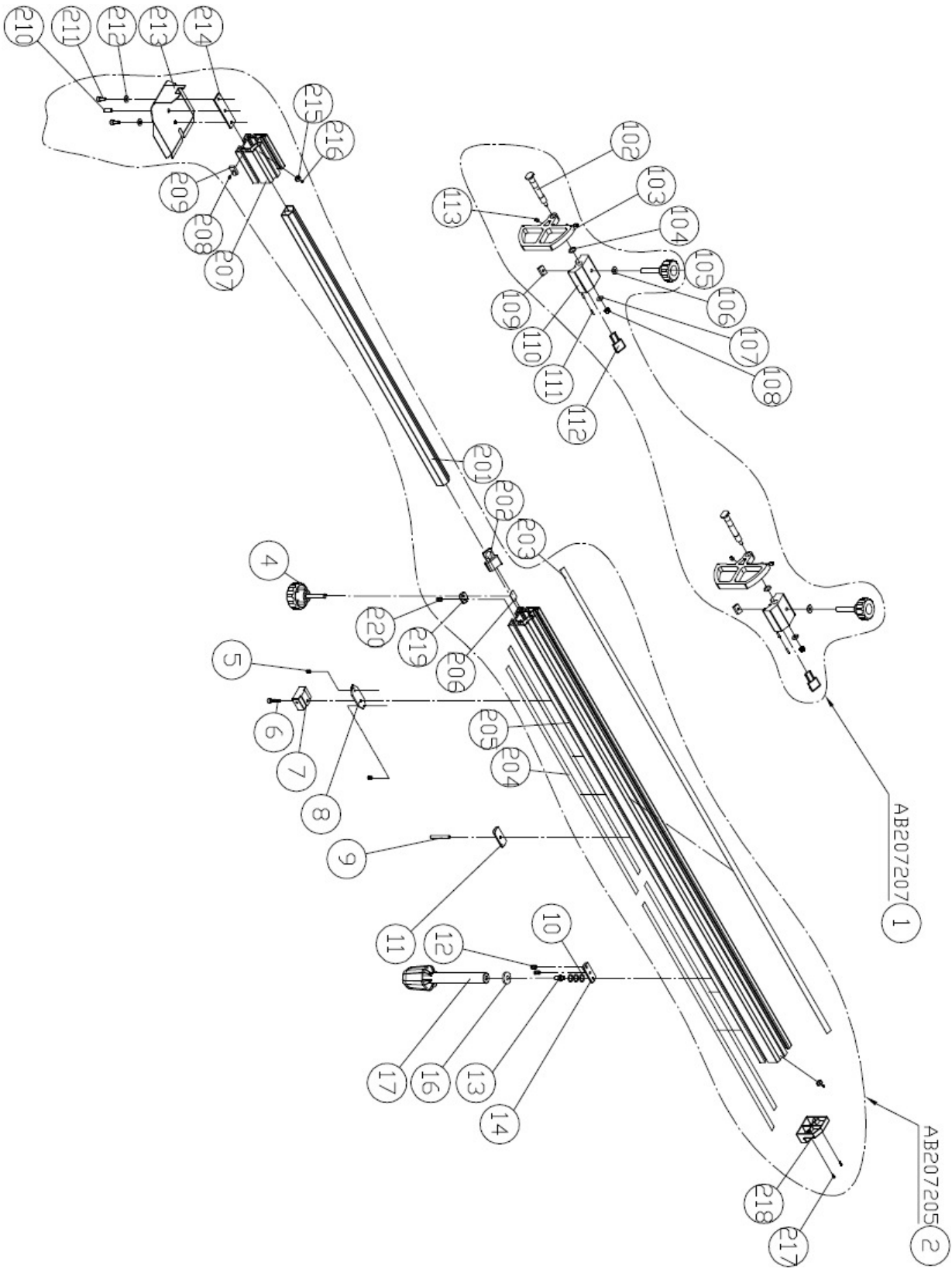

ITEM	PART NO	PART NAME	SIZE	Q'TY	NOTE
1	AB207207	Flip Stop Assembly		2	A
102	207203	Shaft		1	
103	207207	Flip Stop		1	
104	207208	Washer		1	
105	207263	Knob	M8x1.25px42L	1	
106	200472	Washer	M8x20x1	1	
107	WF081818	Washer	M8x18	1	
108	207235	Nut	M8	1	
109	207200	Nut		1	
110	207201	Stop Bracket		1	
111	207223	Pipe		2	
112	207202	Magnifier		1	
113	203286	Set Screw	M8*10	2	
2	AB207205	Ext. Fence Assembly		1	A
201	207212	Extended Tube		1	
202	207213	Magnifier		1	
203	207216	Rule		1	
204	205544	Wearing Tape	875x15	4	
205	207205-1	Ext. Fence		1	
206	207884	Sheet		1	
207	207205-2	Ext. Fence		1	
208	SS069100	Setscrew	M6x6	1	
209	207211	Stop Block		1	
210	SS080500	Setscrew	M8x25	1	
211	SR089400	Cap Screw	M8x16	2	
212	WF081818	Washer	M8x18	2	
213	207210	Locate Plate		1	
214	207209	Plate		1	
215	207204	Nut		2	
216	SS050100	Setscrew	M5x5	2	
217	ST049200	Tap Screw	M4x8	2	
218	207851	Rotate Block		1	
219	207222	Fixed Block		1	
220	SS089300	Setscrew	M8*12	2	
4	200827	Knob	M8x1.25px40L	1	H
5	SS069100	Setscrew	M6*6	2	H
6	SR060500	Cap Screw	M6*25	1	H
7	207221	Fixed Block		1	H
8	207220	Plate		1	H
9	SS081300	Setscrew	M8*65	1	H
10	200069	Fiber Washer	10x18	3	H

ITEM	PART NO	PART NAME	SIZE	Q`TY	NOTE
11	207218	Fixed Block		1	H
12	SS089300	Setscrew	M8*12	2	H
13	206633	Rotate Shaft		1	H
14	207737	Fixed Block		1	H
16	WF083030	Washer	M8x30	1	H
17	203128	Handle		1	H

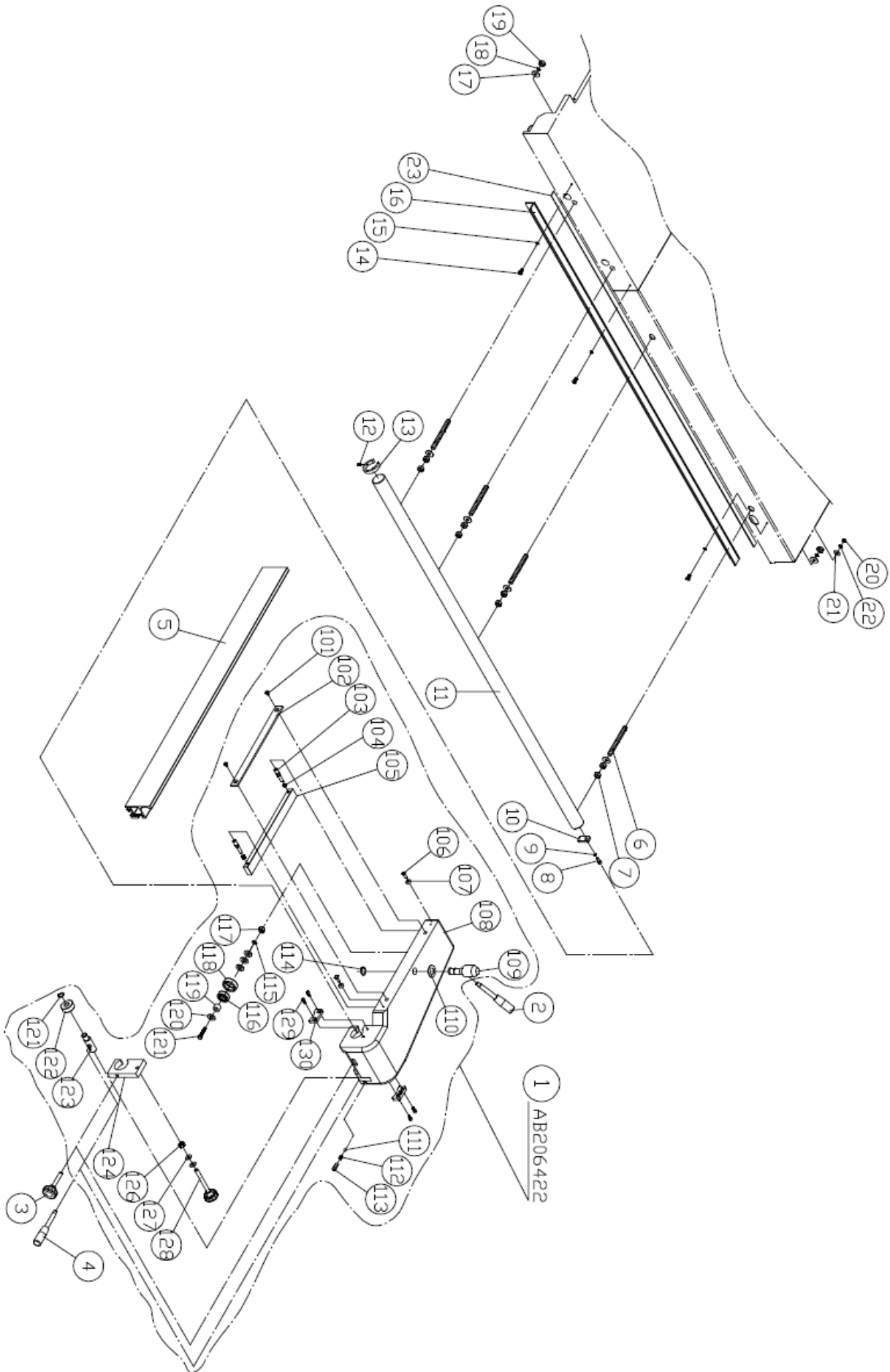

ITEM	PART NO	PART NAME	SIZE	Q`TY	NOTE
1	AB206422	Rip Fence Housing Assembly		1	A
101	SI069400	Counter Sunk Screw	M6*16	2	
102	206433	Fixed Plate		1	
103	203193	Shafts		2	
104	NL081000	Lock Nut	M8	2	
105	200875	Plate		1	
106	SH069400	Hex Head Bolt	M6*16	2	
107	203179	Eccentric Ring		2	
108	206422	Seat		1	GK
109	203213	Eccentric Shaft		1	
110	WF203630	Washer	ψ20*ψ36	1	
111	994181	Steel Ball	ψ8	1	
112	150099	Spring		1	
113	SS100200	Set Screw	M10*10	1	
114	RS200000	Retaining Ring	S20	1	
115	WS080000	Lock Washer	M8	1	
116	BB620202	Ball Bearing	6202ZZ	1	
117	NA081300	Hex Nut	M8	1	
118	203356	Ring		1	
119	206435	Ring		1	
120	WF083030	Washer	M8*ψ30	4	
121	SH080700	Hex Head Bolt	M8*35	1	
122	RS150000	Retaining Ring	S15	1	
123	203649	Ring		1	
124	203650	Shaft		1	
125	206428	Fixed Block		1	
126	NL101700	Lock Nut	M10	1	
127	200069	Washer	M10	2	
128	205114	Adjust Knob	M10*110	1	
129	SR060200	Cap Screw	M6*10	4	
130	205822	Scraper	ψ40 shaft	2	
2	200884	Handle		1	
3	206432	Knob Screw	M10*1.5p*55L	1	
4	200884	Handle		1	
5	205663	Fence Plate	1M	1	
	203191	Fence Plate	1.2M	1	X7 / Optioanl
6	200881	Screw	M12x1.75px115L	4	
7	NH121900	Hex Nut	M12	8	
8	SR089300	Cap Screw	M8x16	1	
9	WS080000	Lock Washer	M8	1	
10	206437	End Washer		1	

ITEM	PART NO	PART NAME	SIZE	Q`TY	NOTE
11	201004	Round Rail		1	
12	SS060200	Setscrew	M6x10	1	
13	200957	Ring Stop		1	
14	SJ069300	Button Head Screw	M6*12	3	H
15	WF061620	Washer	M6*16	3	H
16	207984	Measuring Rule Rail		1	
17	WF132225	Washer	M13x22x2.5	8	
18	WS120000	Lock Washer	M12	4	
19	NH121900	Hex Nut	M12	4	
20	NH061000	Hex Nut	M6	1	H
21	WF061620	Washer	M6x16x2	1	H
22	WS060000	Lock Washer	M6	1	H
23	LM206306	Ruler	mm	1	Standard
	LM001042	Ruler	inch/ mm	1	Optional

2375250M
2375320M

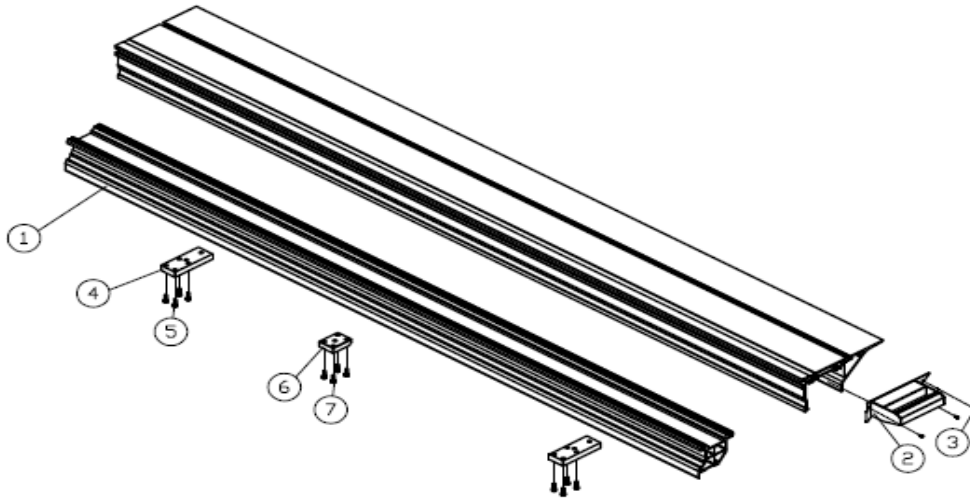

ITEM	PART NO	PART NAME	SIZE	Q`TY	NOTE
1	2375250M	Table	375x2500mm	1	Optional
	2375320M	Table	375x3200mm	1	Optional
2	2375320M-1	Hander		1	T3
3	SJ060200	Hex Head Bolt	M6*10	3	
4	203520	Fixed Block		2	
5	SR080500	Cap Screw	M8*25	8	
6	206581	Fixed Block		1	
7	SR080500	Cap Screw	M8*25	4	

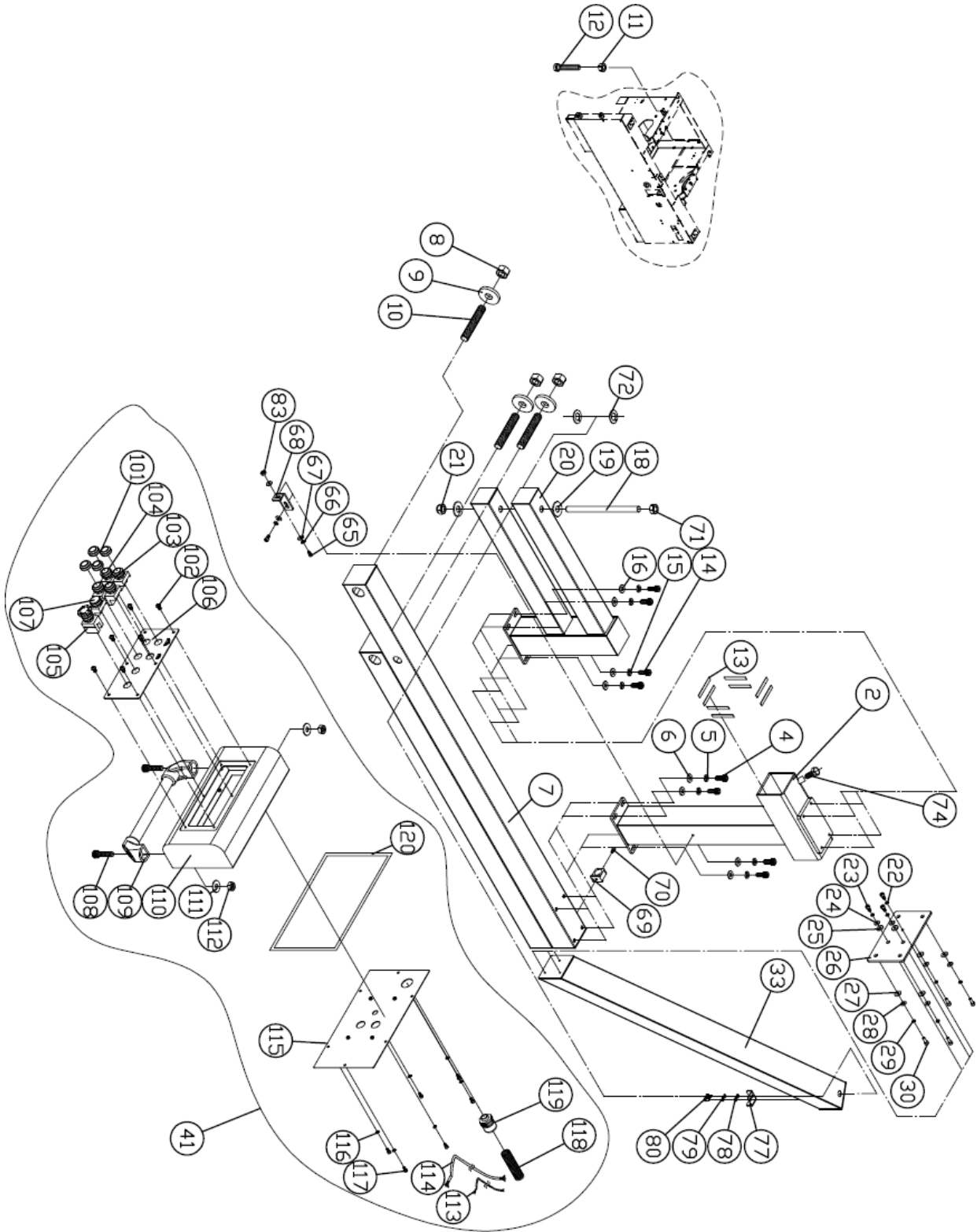

ITEM	PART NO	PART NAME	SIZE	Q'TY	NOTE
2	207770	Fixed Bracket		1	RAL9023
4	SR080500	Cap Screw	M8x25	4	H
5	WS080000	Lock Washer	M8	4	H
6	WF081818	Washer	M8x18	4	H
7	207774	Fixed Bracket		1	RAL9023
8	NH203000	Hex Nut	M20	3	
9	203338	Washer	ψ22*ψ60*t8	3	
10	205116	Screw	M20*130	3	
11	NH121900	Hex Nut	M12	1	
12	SH121400	Hex Head Bolt	M12X70	1	
13	201039	Pad		8	
14	SR080400	Cap Screw	M8x16	4	
15	WS080000	Lock Washer	M8	4	
16	WF081818	Washer	M8x18	4	
18	207773	Bolt		1	
19	WF164030	Washer	M16x40	2	
20	207769	Fixed Bracket		1	RAL9023
21	NL162400	Lock Nut	M16	1	
22	WS050000	Lock Washer	M5	3	
23	SR059400	Cap Screw	M5X16	3	
24	WF051210	Washer	M5×ψ12	2	
25	WF061920	Washer	M6×ψ19	2	
26	207772	Fixed Plate		1	RAL9023
27	WF061920	Washer	M6×ψ19	4	
28	WF051210	Washer	M5×ψ12	4	
29	WS050000	Lock Washer	M5	4	
30	SR059400	Cap Screw	M5X16	4	
33	207771	Fixed Bracket		1	RAL9023
41	AB208102	Case ASM		1	
101	994855A	Dust Cove	R2 PRCF	4	
102	SJ050200	Button Head Screw	M5*10	6	
103	994855	Switch Button-ON	R2 PNF-1A-G	2	
104	994856	Switch Button-OFF	R2 PNF-1B-R	2	
105	994808	Emergency Stop Button	R2 PNR4-1B-R	1	
106	206407	Panel		1	
107	996002	Pilot Lamp	YK.24V φ22 (W)	1	
108	SR100900	Cap Screw	M10*45	2	
109	205557	Handle	MS-737-1-A-330	1	
110	208102	Case		1	RAL9023
111	WF102520	Washer	M10×ψ25	2	
112	NH101700	Hex Nut	M10	2	

ITEM	PART NO	PART NAME	SIZE	Q`TY	NOTE
113	IC208002	Stop Cord		1	
114	IC208001	Control Panel Cord		1	
115	208101	Plate		1	RAL9023
116	WS050000	Lock Washer	M5	6	
117	SR050200	Cap Screw	M5×10	6	
118	204196	Plastic Corrugated Tubing	NFE-08B NGN-12B	1	
119	998808	Strain Relief	N-MGQ32-34B	2	
120	150527	Pad	2x300x7.5(M/M)	5	
65	SR060400	Cap Screw	M6*20	2	
66	WS060000	Lock Washer	M6	2	
67	WF061620	Washer	M6×ψ16	3	
68	207776	Fixed Plate		1	
69	998807	Holder	N-TH-34B	7	
70	SR060200	Cap Screw	M6*10	7	
71	NH162400	Hex Nut	M16	1	
72	994214	Thrust Bearing	LFW-2015	2	
74	SH100600	Hex Head Bolt	M10X30	1	
77	207875	Fixed Plate		1	
78	WF051210	Washer	M5×ψ12	2	
79	WS050000	Lock Washer	M5	2	
80	SR050200	Cap Screw	M5X10	2	
83	NH061000	Hex Nut	M6	1	

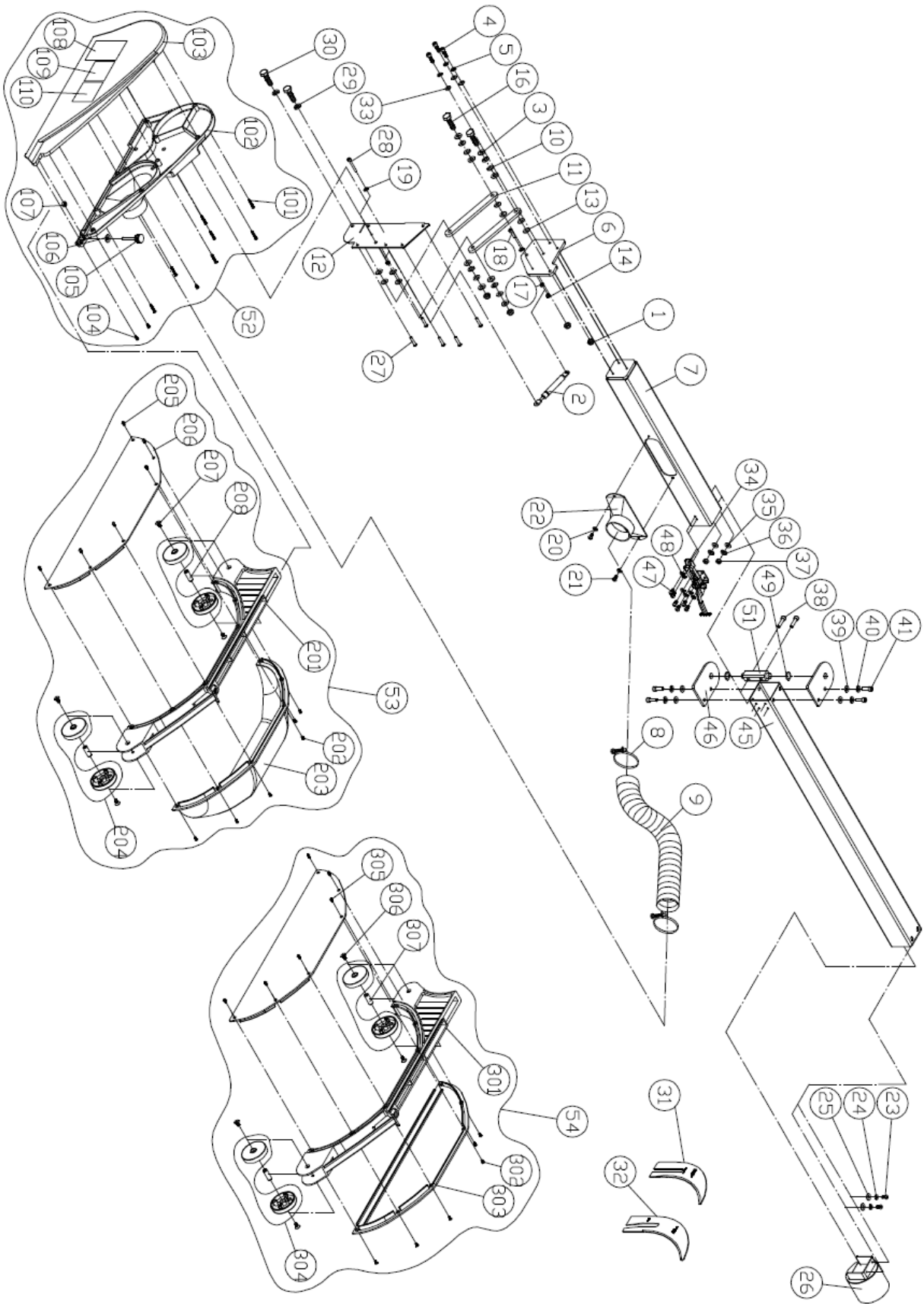

ITEM	PART NO	PART NAME	SIZE	Q'TY	NOTE
1	NL101700	Lock Nut	M10	4	
2	205004	Gas Expansion Cylinder		1	
3	WF102020	Washer	M10* ψ 20	8	
4	SR060400	Cap Screw	M6*20	3	H
5	WS060000	Lock Washer	M6	3	H
6	207987	Fixed Plate		1	
7	207970	Arm		1	R
8	204158	Hose Clamp	3-1/4"	2	
9	HS330004	Hose	ψ 3"x42cm(clear)	1	
10	204263	Washer	ψ 10 \times ψ 20	8	
11	207981	Link		2	
12	207985	Fixed Plate		1	
13	992609	Copper Washer	ψ 20 \times ψ 10 \times 0.5t	8	
14	NL061000	Lock Nut	M6	2	
16	SH100700	Hex Head Bolt	M10*35	2	
17	NH061000	Hex Nut	M6	1	
18	SR060500	Cap Screw	M6*25	1	
19	WS060000	Lock Washer	M6	2	
20	WS060000	Lock Washer	M6	2	H
21	SJ069300	Cap Screw	M6*12	2	H
22	204061	Dust Port		1	
23	SJ069300	Cap Screw	M6*12	2	
24	WS060000	Lock Washer	M6	2	
25	WF061920	Washer	M6* ψ 19	2	
26	206390	Dust Port		1	R
27	SJ060600	Button Head Screw	M6*30	5	
28	SR060900	Cap Screw	M6*45	1	
29	WS100000	Lock Washer	M10	2	
30	SH100700	Hex Head Bolt	M10*35	2	
31	205073	Plate	ϕ 300~350	1	
32	205032	Plate	ϕ 350~400	1	Optional
33	WF061920	Washer	M6* ψ 19	3	H
34	205358	Elbow Type Clamp		1	
35	WF081818	Washer	M8x18	2	
36	WS080000	Lock Washer	M8	2	
37	NH081300	Hex Nut	M8	2	
38	SR080600	Cap Screw	M8x30	2	
39	WF081818	Washer	M8x18	4	
40	WS080000	Lock Washer	M8	4	
41	SR080500	Cap Screw	M8x25	4	
45	207971	Square Tube		1	R

ITEM	PART NO	PART NAME	SIZE	Q`TY	NOTE
46	207973	Plate		2	R
47	SJ060200	Cap Screw	M6x10	6	
48	WS060000	Lock Washer	M6	6	
49	992627	Copper Washer	ψ24*ψ16*0.3t	2	
51	207975	Shaft		1	
52	AB207866	Rear Cover ASM		1	
101	ST030500	Tap Screw	M3.5x25	7	
102	207866	Rear Cover		1	
103	207865	Front Cover		1	
104	ST040200	Tap Screw	M4x10	3	
105	207882	Knob		1	
106	WF081818	Washer	M8x18	1	
107	NH081300	Hex Nut	M8	1	
108	LM207031	Warning Label		1	
109	LM207032	Warning Label		1	
110	LM207033	Warning Label		1	
53	AB205355	Protection Hood ASM		1	
201	207867	Guard		1	
202	SP040200	Pan Head Screw	M4*10	6	
203	205355	Protection Hood		1	
204	AB207868	Roller ASM		2	
205	SP040200	Pan Head Screw	M4*10	6	
206	205356	Protection Hood		1	
207	SI060200	Counter Sunk Screw	M6*10	4	
208	207883	Shaft		2	
54	AB205356	Protection Hood ASM		1	Optional
301	207867	Guard		1	
302	SP040200	Pan Head Screw	M4*10	6	
303	205356	Protection Hood		2	
304	AB207868	Roller ASM		2	
305	SP040200	Pan Head Screw	M4*10	6	
306	SI060200	Counter Sunk Screw	M6*10	4	
307	207883	Shaft		2	

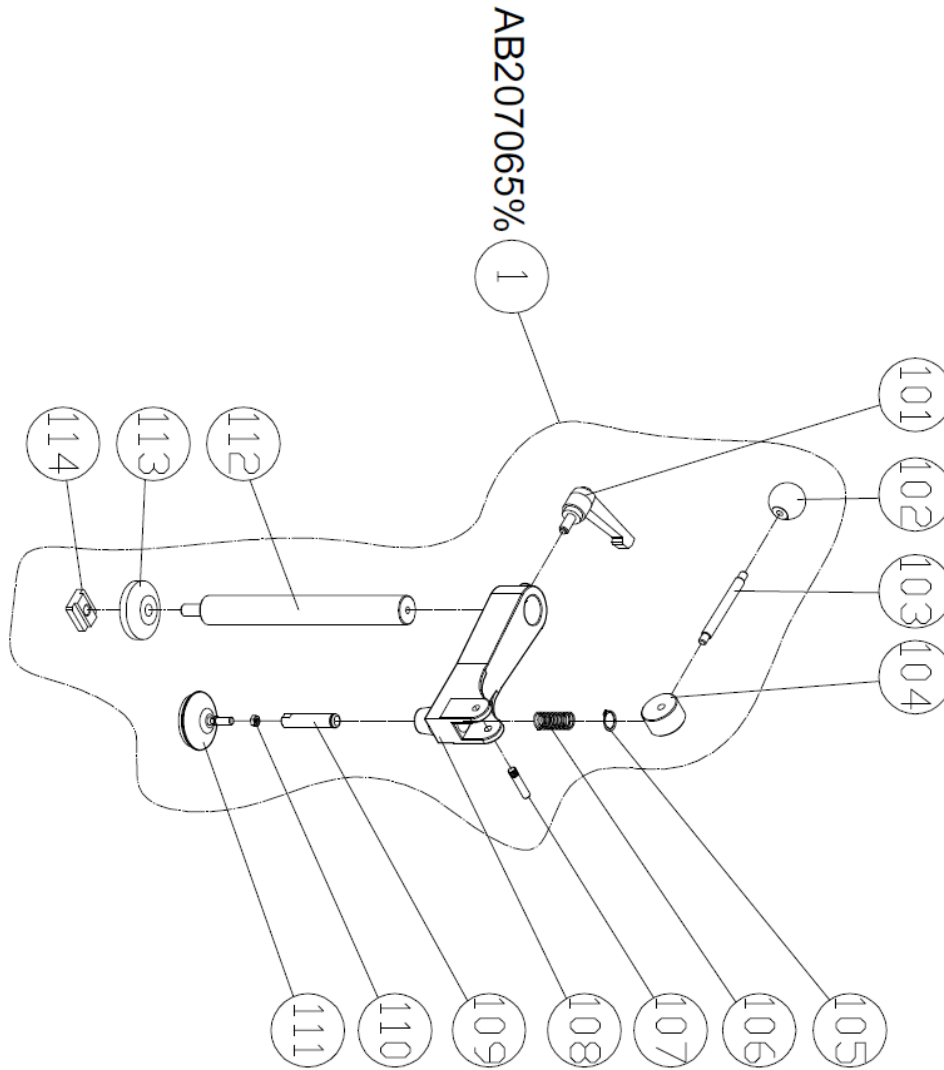

ITEM	PART NO	PART NAME	SIZE	Q`TY	NOTE
1	AB207065-2	Down Press ASM		1	
101	207143	Adjust Handle		1	
102	100271	Ball Knob	M8×P1.25	1	
103	207070	Handle Bar		1	
104	207067	Cam		1	
105	RS140000	Ext. Retaining Ring	S14	1	
106	207069	Spring		1	
107	207145	Pin		1	
108	207065	Down Press		1	
109	207068	Shaft		1	
110	NH602300	Hex Nut	5/16	1	
111	200807	Large Washer		1	
112	205253	Shaft		1	
113	200809	Washer		1	
114	205830	T-Nut	AB207065	1	

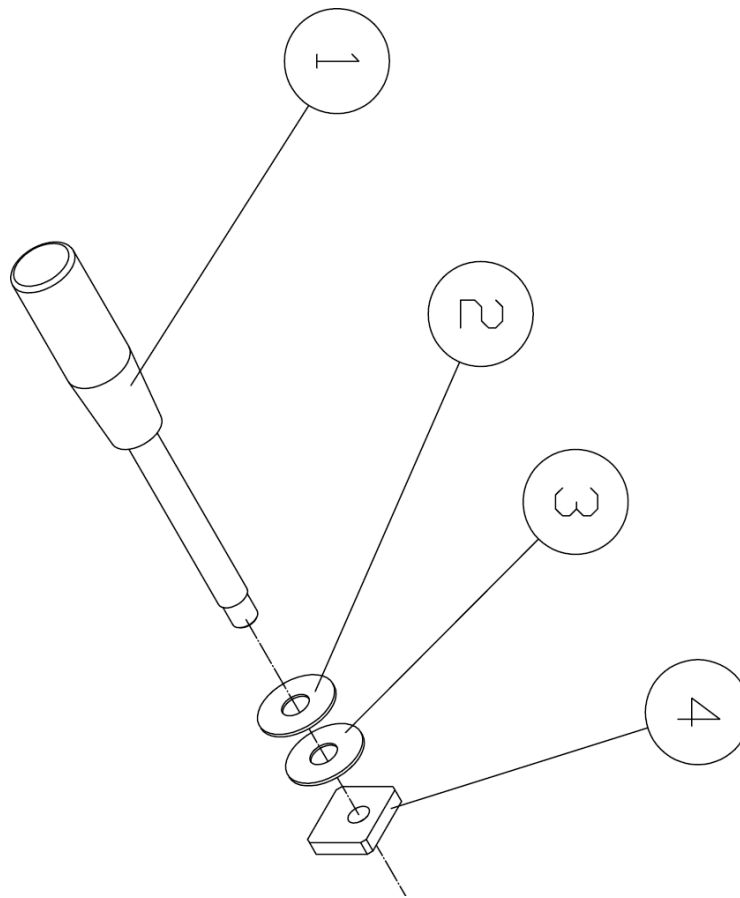

ITEM	PART NO	PART NAME	SIZE	Q`TY	NOTE
1	200939	Handle		1	
2	WF123030	Washer	M12x30	1	
3	992496	Plastic Washer	φ13xφ25	1	t=2
4	201849	T-Nut	M12x1.75p	1	

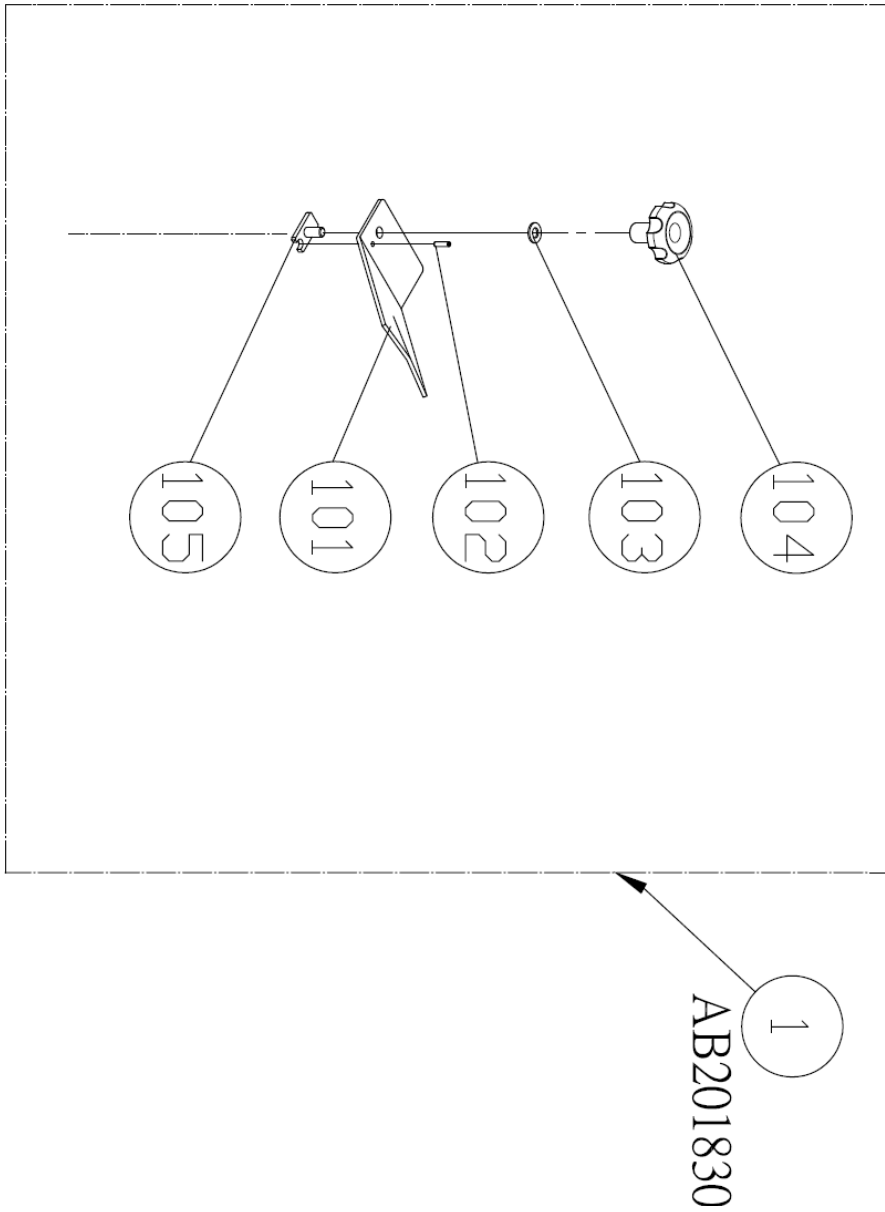

ITEM	PART NO	PART NAME	SIZE	Q`TY	NOTE
1	AB201830	Edge Shoe Plate Assembly		1	
101	201830	Edge Shoe Plate		1	
102	PS051600	Spint Pin	φ5xφ16	1	
103	WF102025	Washer	M10x25	1	
104	203718	Knob	M10	1	
105	201829	T-Nut	M10x1.5p	1	

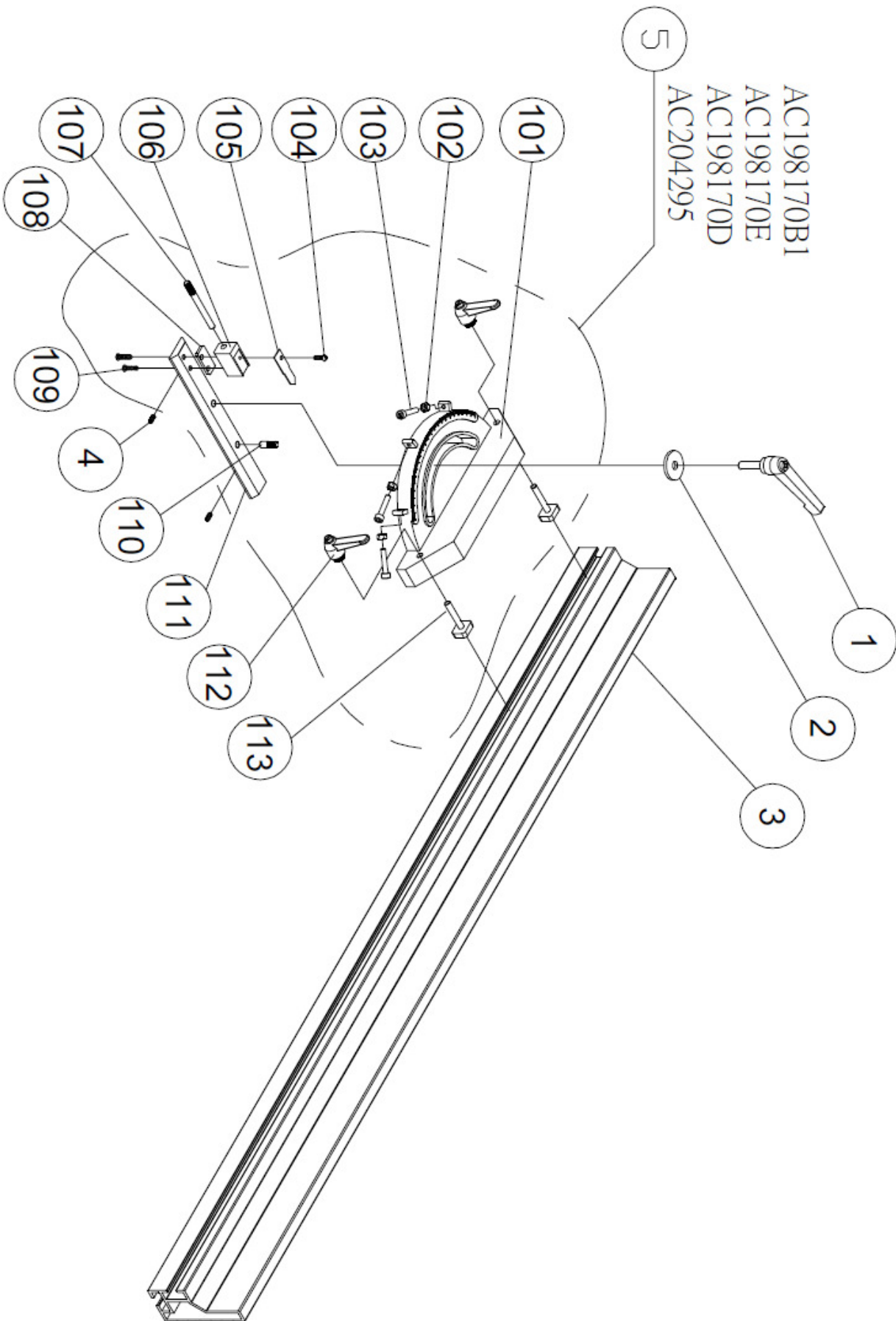

ITEM	PART NO	PART NAME	SIZE	Q`TY	NOTE
1	200814	Fasten Handle		1	
2	WF083030	Flat Washer	M8× φ 30	1	
3	200526	Fence Plate		1	
4	201632	Spring plungers with ball	M4×9	2	S/B sliding table
5	AC198170B1	Miter Gauge Assembly	for B1 sliding table	1	S, A
	AC198170D	Miter Gauge Assembly	for D.M sliding table	1	S, A
	AC198170E	Miter Gauge Assembly	for E sliding table	1	S, A
	AC204295	Miter Gauge Assembly	for 1600mm sliding table	1	S, A
101	198170	Miter Gauge Body		1	
102	NH050800	Hex Nut	M5	3	
103	SR050500	Cap Screw	M5×25	3	
104	SP049300	Pan Head Bolt	M4×12	1	
105	201366	Pointer		1	
106	201365	Fixed Block		1	
107	201367	Stop Bar		1	
108	206621	End Washer	T=3MM	1	S/E sliding table
109	SP049400	Pan Head Bolt	M4×16	2	
110	198174	Shaft		1	
111	201364B1	Fixed Base	for B1 sliding table	1	Optional
	205829	Fixed Base	for D.E.M sliding table	1	Optional
	204295	Fixed Base	for 1600mm sliding table	1	Optional
112	198170-1	Adjust Handle		2	
113	207667	T- Bolt		2	

LAGUNA

LAGUNA TOOLS
17101 Murphy Ave.
Irvine, California 92614
Ph: 800.234.1976
www.lagunatools.com

© 2013 Laguna Tools, Inc. All rights reserved.