

*If you have questions or comments, contact us.
Pour toute question ou tout commentaire, nous contacter.
Si tiene dudas o comentarios, contáctenos.*

1-800-4-DEWALT • www.dewalt.com

**INSTRUCTION MANUAL
GUIDE D'UTILISATION
MANUAL DE INSTRUCCIONES**

INSTRUCTIVO DE OPERACIÓN, CENTROS DE SERVICIO Y PÓLIZA DE GARANTÍA. **ADVERTENCIA:** LÉASE ESTE INSTRUCTIVO ANTES DE USAR EL PRODUCTO.

DEWALT®

DWE402, DWE402N, DWE402G, DWE4214

Heavy-Duty Small Angle Grinder

Petites meuleuses angulaires de service intensif

Esmeriladoras angulares pequeñas para trabajo pesado

Definitions: Safety Guidelines

The definitions below describe the level of severity for each signal word. Please read the manual and pay attention to these symbols.

⚠ DANGER: Indicates an imminently hazardous situation which, if not avoided, **will** result in **death or serious injury**.

⚠ WARNING: Indicates a potentially hazardous situation which, if not avoided, **could** result in **death or serious injury**.

⚠ CAUTION: Indicates a potentially hazardous situation which, if not avoided, **may** result in **minor or moderate injury**.

NOTICE: Indicates a practice **not related to personal injury** which, if not avoided, **may** result in **property damage**.

IF YOU HAVE ANY QUESTIONS OR COMMENTS ABOUT THIS OR ANY DEWALT TOOL, CALL US TOLL FREE AT: **1-800-4-DeWALT (1-800-433-9258)**.



WARNING: To reduce the risk of injury, read the instruction manual.

General Power Tool Safety Warnings



WARNING! Read all safety warnings and all instructions.

Failure to follow the warnings and instructions may result in electric shock, fire and/or serious injury.

SAVE ALL WARNINGS AND INSTRUCTIONS FOR FUTURE REFERENCE

The term "power tool" in the warnings refers to your mains-operated (corded) power tool or battery-operated (cordless) power tool.

1) WORK AREA SAFETY

- Keep work area clean and well lit.** Cluttered or dark areas invite accidents.
- Do not operate power tools in explosive atmospheres, such as in the presence of flammable liquids, gases or dust.** Power tools create sparks which may ignite the dust or fumes.
- Keep children and bystanders away while operating a power tool.** Distractions can cause you to lose control.

2) ELECTRICAL SAFETY

- Power tool plugs must match the outlet. Never modify the plug in any way. Do not use any adapter plugs with earthed (grounded) power tools.** Unmodified plugs and matching outlets will reduce risk of electric shock.
- Avoid body contact with earthed or grounded surfaces such as pipes, radiators ranges and refrigerators.** There is an increased risk of electric shock if your body is earthed or grounded.
- Do not expose power tools to rain or wet conditions.** Water entering a power tool will increase the risk of electric shock.
- Do not abuse the cord. Never use the cord for carrying, pulling or unplugging the power tool. Keep cord away from heat, oil, sharp edges or moving parts.** Damaged or entangled cords increase the risk of electric shock.
- When operating a power tool outdoors, use an extension cord suitable for outdoor use.** Use of a cord suitable for outdoor use reduces the risk of electric shock.
- If operating a power tool in a damp location is unavoidable, use a ground fault circuit interrupter (GFCI) protected supply.** Use of a GFCI reduces the risk of electric shock.

3) PERSONAL SAFETY

- a) **Stay alert, watch what you are doing and use common sense when operating a power tool. Do not use a power tool while you are tired or under the influence of drugs, alcohol or medication.** A moment of inattention while operating power tools may result in serious personal injury.
- b) **Use personal protective equipment. Always wear eye protection.** Protective equipment such as dust mask, non-skid safety shoes, hard hat, or hearing protection used for appropriate conditions will reduce personal injuries.
- c) **Prevent unintentional starting. Ensure the switch is in the off position before connecting to power source and/or battery pack, picking up or carrying the tool.** Carrying power tools with your finger on the switch or energizing power tools that have the switch on invites accidents.
- d) **Remove any adjusting key or wrench before turning the power tool on.** A wrench or a key left attached to a rotating part of the power tool may result in personal injury.
- e) **Do not overreach. Keep proper footing and balance at all times.** This enables better control of the power tool in unexpected situations.
- f) **Dress properly. Do not wear loose clothing or jewelry. Keep your hair, clothing and gloves away from moving parts.** Loose clothes, jewelry or long hair can be caught in moving parts.
- g) **If devices are provided for the connection of dust extraction and collection facilities, ensure these are connected and properly used.** Use of dust collection can reduce dust-related hazards.

4) POWER TOOL USE AND CARE

- a) **Do not force the power tool. Use the correct power tool for your application.** The correct power tool will do the job better and safer at the rate for which it was designed.

- b) **Do not use the power tool if the switch does not turn it on and off.** Any power tool that cannot be controlled with the switch is dangerous and must be repaired.
- c) **Disconnect the plug from the power source and/or the battery pack from the power tool before making any adjustments, changing accessories, or storing power tools.** Such preventive safety measures reduce the risk of starting the power tool accidentally.
- d) **Store idle power tools out of the reach of children and do not allow persons unfamiliar with the power tool or these instructions to operate the power tool.** Power tools are dangerous in the hands of untrained users.
- e) **Maintain power tools. Check for misalignment or binding of moving parts, breakage of parts and any other condition that may affect the power tool's operation. If damaged, have the power tool repaired before use.** Many accidents are caused by poorly maintained power tools.
- f) **Keep cutting tools sharp and clean.** Properly maintained cutting tools with sharp cutting edges are less likely to bind and are easier to control.
- g) **Use the power tool, accessories and tool bits, etc. in accordance with these instructions, taking into account the working conditions and the work to be performed.** Use of the power tool for operations different from those intended could result in a hazardous situation.

5) SERVICE

- a) **Have your power tool serviced by a qualified repair person using only identical replacement parts.** This will ensure that the safety of the power tool is maintained.

SAFETY INSTRUCTIONS FOR ALL OPERATIONS

Safety Warnings Common for Grinding, Sanding, Wire Brushing, Polishing or Abrasive, Cutting-Off Operations

- a) *This power tool is intended to function as a grinder, sander, wire brush, polisher or cut-off tool. Read all safety warnings, instructions, illustrations and specifications provided with this power tool. Failure to follow all instructions listed below may result in electric shock, fire and/or serious injury.*
- b) *Do not use accessories which are not specifically designed and recommended by the tool manufacturer. Just because the accessory can be attached to your power tool, it does not assure safe operation.*
- c) *The rated speed of the accessory must be at least equal to the maximum speed marked on the power tool. Accessories running faster than their rated speed can break and fly apart.*
- d) *The outside diameter and the thickness of your accessory must be within the capacity rating of your power tool. Incorrectly sized accessories cannot be adequately guarded or controlled.*
- e) *Threaded mounting of accessories must match the grinder spindle thread. For accessories mounted by flanges, the arbor hole of the accessory must fit the locating diameter of the flange. Accessories that do not match the mounting hardware of the power tool will run out of balance, vibrate excessively and may cause loss of control.*
- f) *Do not use a damaged accessory. Before each use inspect the accessory such as abrasive wheels for chips and cracks, backing pad for cracks, tear or excess wear, wire brush for loose or cracked wires. If power tool or accessory is dropped, inspect for damage or install an undamaged accessory. After inspecting and installing an accessory, position yourself and bystanders away from the plane of the rotating accessory and run the power tool at maximum no-load speed for one minute. Damaged accessories will normally break apart during this test time.*
- g) *Wear personal protective equipment. Depending on application, use face shield, safety goggles or safety glasses. As appropriate, wear dust mask, hearing protectors, gloves and workshop apron capable of stopping small abrasive or workpiece fragments. The eye protection must be capable of stopping flying debris generated by various operations. The dust mask or respirator must be capable of filtering particles generated by your operation. Prolonged exposure to high intensity noise may cause hearing loss.*
- h) *Keep bystanders a safe distance away from work area. Anyone entering the work area must wear personal protective equipment. Fragments of workpiece or of a broken accessory may fly away and cause injury beyond immediate area of operation.*
- i) *Hold the power tool by insulated gripping surfaces only, when performing an operation where the cutting accessory may contact hidden wiring or its own cord. Cutting accessory contacting a "live" wire may make exposed metal parts of the power tool "live" and could give the operator an electric shock.*

- j) **Position the cord clear of the spinning accessory.** If you lose control, the cord may be cut or snagged and your hand or arm may be pulled into the spinning accessory.
- k) **Never lay the power tool down until the accessory has come to a complete stop.** The spinning accessory may grab the surface and pull the power tool out of your control.
- l) **Do not run the power tool while carrying it at your side.** Accidental contact with the spinning accessory could snag your clothing, pulling the accessory into your body.
- m) **Regularly clean the power tool's air vents.** The motor's fan will draw the dust inside the housing and excessive accumulation of powdered metal may cause electrical hazards.
- n) **Do not operate the power tool near flammable materials.** Sparks could ignite these materials.
- o) **Do not use accessories that require liquid coolants.** Using water or other liquid coolants may result in electrocution or shock.
- p) **Do not use Type 11 (flaring cup) wheels on this tool.** Using inappropriate accessories can result in injury.
- q) **Always use side handle. Tighten the handle securely.** The side handle should always be used to maintain control of the tool at all times.
- r) **When starting the tool with a new or replacement wheel, or a new or replacement wire brush installed, hold the tool in a well protected area and let it run for one minute.** If the wheel has an undetected crack or flaw, it should burst in less than one minute. If the wire brush has loose wires, they will be detected. Never start the tool with a person in line with the wheel. This includes the operator.
- s) **Use of accessories not specified in this manual is not recommended and may be hazardous.** Use of power boosters that would cause the tool to be driven at speeds greater than its rated speed constitutes misuse.

- t) **Use clamps or another practical way to secure and support the workpiece to a stable platform.** Holding the work by hand or against your body leaves it unstable and may lead to loss of control.
- u) **Avoid bouncing the wheel or giving it rough treatment.** If this occurs, stop the tool and inspect the wheel for cracks or flaws.
- v) **Always handle and store wheels in a careful manner.**
- w) **Do not operate this tool for long periods of time.** Vibration caused by the operating action of this tool may cause permanent injury to fingers, hands, and arms. Use gloves to provide extra cushion, take frequent rest periods, and limit daily time of use.
- x) **Air vents often cover moving parts and should be avoided.** Loose clothes, jewelry or long hair can be caught in moving parts.

Causes and Operator Prevention of Kickback

Kickback is a sudden reaction to a pinched or snagged rotating wheel, backing pad, brush or any other accessory. Pinching or snagging causes rapid stalling of the rotating accessory which in turn causes the uncontrolled power tool to be forced in the direction opposite of the accessory's rotation at the point of the binding.

For example, if an abrasive wheel is snagged or pinched by the workpiece, the edge of the wheel that is entering into the pinch point can dig into the surface of the material causing the wheel to climb out or kick out. The wheel may either jump toward or away from the operator, depending on direction of the wheel's movement at the point of pinching. Abrasive wheels may also break under these conditions.

Kickback is the result of tool misuse and/or incorrect operating procedures or conditions and can be avoided by taking proper precautions as given below:

- a) **Maintain a firm grip on the power tool and position your body and arm to allow you to resist kickback forces. Always use auxiliary handle, if provided, for maximum control over kickback or torque reaction during start up.** The operator can control torque reaction or kickback forces, if proper precautions are taken.
- b) **Never place your hand near the rotating accessory.** Accessory may kickback over your hand.
- c) **Do not position your body in the area where power tool will move if kickback occurs.** Kickback will propel the tool in direction opposite to the wheel's movement at the point of snagging.
- d) **Use special care when working corners, sharp edges etc. Avoid bouncing and snagging the accessory.** Corners, sharp edges or bouncing have a tendency to snag the rotating accessory and cause loss of control or kickback.
- e) **Do not attach a saw chain woodcarving blade or toothed saw blade.** Such blades create frequent kickback and loss of control.

Safety Warnings Specific for Grinding and Abrasive Cutting-Off Operations

- a) **Use only wheel types that are recommended for your power tool and the specific guard designed for the selected wheel.** Wheels for which the power tool was not designed cannot be adequately guarded and are unsafe.
- b) **The grinding surface of center depressed wheels must be mounted below the plane of the guard lip.** An improperly mounted wheel that projects through the plane of the guard lip cannot be adequately protected.

- c) **The guard must be securely attached to the power tool and positioned for maximum safety, so the least amount of wheel is exposed towards the operator.** The guard helps to protect the operator from broken wheel fragments, accidental contact with wheel and sparks that could ignite clothing.
- d) **Wheels must be used only for recommended applications. For example: do not grind with the side of cut-off wheel.** Abrasive cut-off wheels are intended for peripheral grinding, side forces applied to these wheels may cause them to shatter.
- e) **Always use undamaged wheel flanges that are of correct size and shape for your selected wheel.** Proper wheel flanges support the wheel thus reducing the possibility of wheel breakage. Flanges for cut-off wheels may be different from grinding wheel flanges.
- f) **Do not use worn down wheels from larger power tools.** Wheel intended for larger power tool is not suitable for the higher speed of a smaller tool and may burst.

Additional Safety Warnings Specific for Abrasive Cutting-Off Operations

- a) **Do not "jam" the cut-off wheel or apply excessive pressure. Do not attempt to make an excessive depth of cut.** Overstressing the wheel increases the loading and susceptibility to twisting or binding of the wheel in the cut and the possibility of kickback or wheel breakage.
- b) **Do not position your body in line with and behind the rotating wheel.** When the wheel, at the point of operation, is moving away from your body, the possible kickback may propel the spinning wheel and the power tool directly at you.
- c) **When wheel is binding or when interrupting a cut for any reason, switch off the power tool and hold the power tool motionless until the wheel comes to a complete**

stop. Never attempt to remove the cut-off wheel from the cut while the wheel is in motion otherwise kickback may occur. Investigate and take corrective action to eliminate the cause of wheel binding.

- d) **Do not restart the cutting operation in the workpiece. Let the wheel reach full speed and carefully reenter the cut.** The wheel may bind, walk up or kickback if the power tool is restarted in the workpiece.
- e) **Support panels or any oversized workpiece to minimize the risk of wheel pinching and kickback.** Large workpieces tend to sag under their own weight. Supports must be placed under the workpiece near the line of cut and near the edge of the workpiece on both sides of the wheel.
- f) **Use extra caution when making a “pocket cut” into existing walls or other blind areas.** The protruding wheel may cut gas or water pipes, electrical wiring or objects that can cause kickback.

Safety Warnings Specific for Sanding Operations

- a) **Do not use excessively oversized sanding disc paper. Follow manufacturers recommendations, when selecting sanding paper.** Larger sanding paper extending beyond the sanding pad presents a laceration hazard and may cause snagging, tearing of the disc or kickback.

Safety Warnings Specific for Polishing Operations

- a) **Do not allow any loose portion of the polishing bonnet or its attachment strings to spin freely. Tuck away or trim any loose attachment strings.** Loose and spinning attachment strings can entangle your fingers or snag on the workpiece.

Safety Warnings Specific for Wire Brushing Operations

- a) **Be aware that wire bristles are thrown by the brush even during ordinary operation. Do not overstress the wires by applying excessive load to the brush.** The wire bristles can easily penetrate light clothing and/or skin.
- b) **If the use of a guard is recommended for wire brushing, do not allow any interference of the wire wheel or brush with the guard.** Wire wheel or brush may expand in diameter due to work and centrifugal forces.
- c) **Safety goggles or safety glasses with side shields and a full face shield compliant with ANSI Z87.1 MUST be worn by the operator and others that are within 50' (15.2 m) of the use of this product.**

Additional Safety Information

⚠WARNING: ALWAYS use safety glasses. Everyday eyeglasses are NOT safety glasses. Also use face or dust mask if cutting operation is dusty. ALWAYS WEAR CERTIFIED SAFETY EQUIPMENT:

- ANSI Z87.1 eye protection (CAN/CSA Z94.3),
- ANSI S12.6 (S3.19) hearing protection,
- NIOSH/OSHA/MSHA respiratory protection.

⚠WARNING: Some dust created by power sanding, sawing, grinding, drilling, and other construction activities contains chemicals known to the State of California to cause cancer, birth defects or other reproductive harm. Some examples of these chemicals are:

- lead from lead-based paints,
- crystalline silica from bricks and cement and other masonry products, and
- arsenic and chromium from chemically-treated lumber.

Your risk from these exposures varies, depending on how often you do this type of work. To reduce your exposure to these chemicals: work in a well ventilated area, and work with approved safety equipment, such as those dust masks that are specially designed to filter out microscopic particles.

- **Avoid prolonged contact with dust from power sanding, sawing, grinding, drilling, and other construction activities. Wear protective clothing and wash exposed areas with soap and water.** Allowing dust to get into your mouth, eyes, or lay on the skin may promote absorption of harmful chemicals.

⚠WARNING: Use of this tool can generate and/or disperse dust, which may cause serious and permanent respiratory or other injury. Always use NIOSH/OSHA approved respiratory protection appropriate for the dust exposure. Direct particles away from face and body.

⚠WARNING: Always wear proper personal hearing protection that conforms to ANSI S12.6 (S3.19) during use. Under some conditions and duration of use, noise from this product may contribute to hearing loss.

⚠WARNING: Always use eye protection. All users and bystanders must wear eye protection that conforms to ANSI Z87.1.

⚠WARNING: When not in use, place grinder on a stable surface where it will not move inadvertently, roll or cause a tripping or falling hazard. The grinder may stand upright on the battery pack but may be easily knocked over. Serious personal injury may result.

⚠WARNING: The grinding wheel or accessory may loosen during coast-down of the tool when shut off. If grinding wheel or accessory loosens, it may dismount from the machine and may cause serious personal injury.

⚠CAUTION: To reduce the risk of personal injury, use extra care when working into a corner or edge because a sudden, sharp movement of the tool may be experienced when the wheel or other accessory contacts a secondary surface or a surface edge.

- The label on your tool may include the following symbols. The symbols and their definitions are as follows:

V.....	volts	Hz.....	hertz
sfpm.....	surface feet per minute	SPM.....	strokes per minute
min.....	minutes	A.....	amperes
== or DC....	direct current	W.....	watts
Ⓛ.....	Class I Construction (grounded)	Ⓚ.....	Class II Construction (double insulated)
≈ or AC/DC ..	alternating or direct current	~ or AC.....	alternating current
.../min.....	per minute	no	no load speed
BPM	beats per minute	n.....	rated speed
IPM.....	impacts per minute	⊕.....	earthing terminal
RPM.....	revolutions per minute	⚠.....	safety alert symbol

- **An extension cord must have adequate wire size (AWG or American Wire Gauge) for safety.** The smaller the gauge number of the wire, the greater the capacity of the cable, that is 16 gauge has more capacity than 18 gauge. An undersized cord will cause a drop in line voltage resulting in loss of power and overheating. When using more than one extension to make up the total length, be sure each individual extension contains at least the minimum wire size. The following table shows the correct size to use depending on cord length and nameplate ampere rating. If in doubt, use the next heavier gauge. The smaller the gauge number, the heavier the cord.

Minimum Gauge for Cord Sets						
Ampere Rating		Volts	Total Length of Cord in Feet (meters)			
		120 V	25 (7.6)	50 (15.2)	100 (30.5)	150 (45.7)
		240 V	50 (15.2)	100 (30.5)	200 (61.0)	300 (91.4)
More Than	Not More Than	AWG				
0	6		18	16	16	14
6	10		18	16	14	12
10	12		16	16	14	12
12	16		14	12	Not Recommended	

SAVE THESE INSTRUCTIONS FOR FUTURE USE

COMPONENTS (Fig. 1)

⚠️WARNING: Never modify the power tool or any part of it. Damage or personal injury could result.

- A. Paddle switch (DWE402, DWE402N, DWE402G)
- B. Slider switch (DWE4214)
- C. Lock-off lever
- D. Spindle lock button
- E. Spindle
- F. Side handle
- G. Anti-lockup backing flange
- H. Threaded locking flange
- I. Type 27 Guard (4-1/2" / 115mm)
- J. Guard release lever
- K. Lock on button (DWE402, DWE402G)

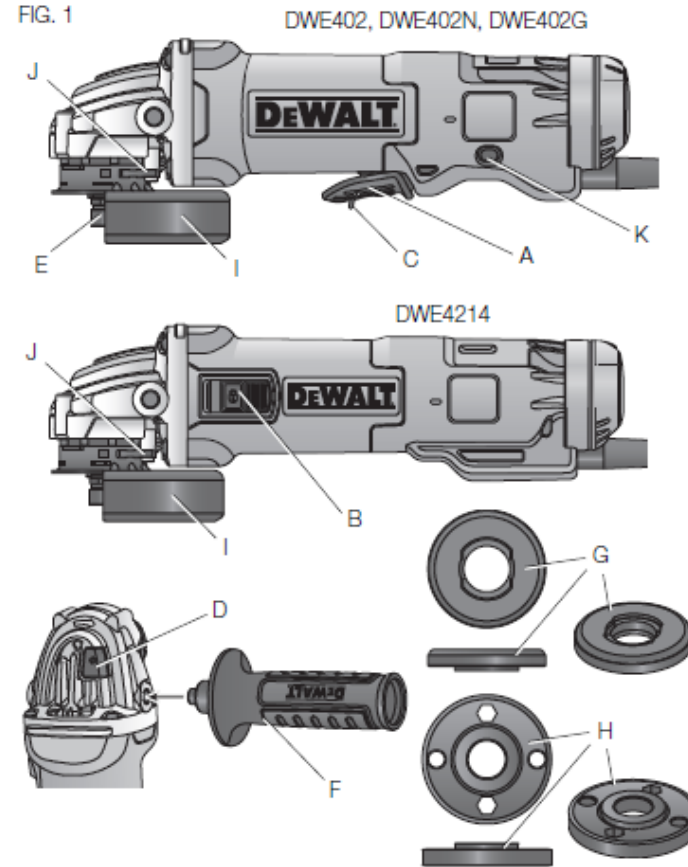

Motor

Be sure your power supply agrees with the nameplate marking. Voltage decrease of more than 10% will cause loss of power and overheating. DEWALT tools are factory tested; if this tool does not operate, check power supply.

INTENDED USE

These heavy-duty small angle grinders have been designed for professional grinding, sanding, wire brush, and cut-off applications at various work sites (i.e., construction sites).

DO NOT use under wet conditions or in presence of flammable liquids or gases.

These heavy-duty small angle grinders are professional power tools. **DO NOT** let children come into contact with the tool. Supervision is required when inexperienced operators use this tool.

ASSEMBLY AND ADJUSTMENTS

⚠️WARNING: To reduce the risk of injury, turn unit off and disconnect it from power source before making any adjustments or removing/installing attachments or accessories. An accidental start-up can cause injury.

Attaching Side Handle (Fig. 2)

The side handle (F) can be fitted to either side of the gear case in the threaded holes. Before using the tool, check that the handle is tightened securely.

To improve user comfort, the gear case will rotate 90° for cutting operations.

Rotating the Gear Case (Fig. 2)

1. Remove the four corner screws attaching the gear case to motor housing.

2. Without separating the gear case from motor housing, rotate the gear case head to desired position.

NOTE: If the gear case and motor housing become separated by more than 1/8" (3.17 mm), the tool must be serviced and re-assembled by a DEWALT service center. Failure to have the tool serviced may cause brush, motor and bearing failure.

3. Reinstall screws to attach the gear case to the motor housing. Tighten screws to 20 in.-lbs. torque. Overtightening could cause screws to strip.

FIG. 2

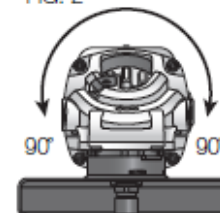

Accessories

The capacity of this tool is 4 1/2" (115 mm) diameter x 1/4" (6.35 mm) thick grinding or cutting wheels. It is important to choose the correct guards, backing pads and flanges to use with grinder accessories. See pages 10 and 11 for information on choosing the correct accessories.

⚠️WARNING: Accessories must be rated for at least the speed recommended on the tool warning label. Wheels and other accessories running over their rated accessory speed may fly apart and cause injury. Threaded accessories must have a 5/8"-11 hub. Every unthreaded accessory must have a 7/8" (22.2 mm) arbor hole. If it does not, it may have been designed for a circular saw. Use only the accessories shown on pages 10 and 11 of this manual. Accessory ratings must always be above tool speed as shown on tool nameplate.

⚠️WARNING: Handle and store all abrasive wheels carefully to prevent damage from thermal shock, heat, mechanical damage, etc. Store in a dry protected area free from high humidity, freezing temperatures or extreme temperature changes.

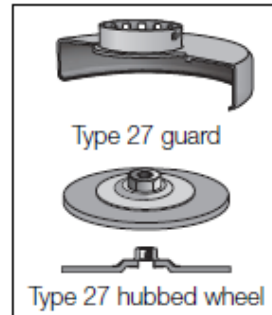
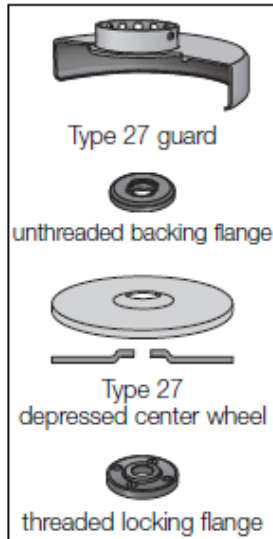
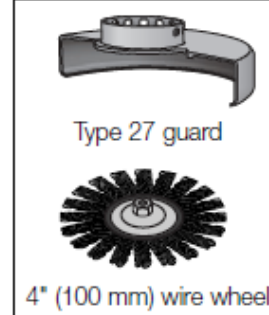
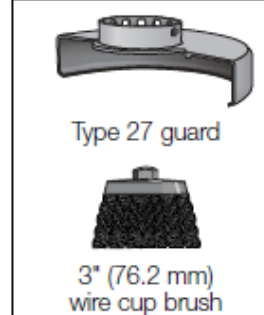
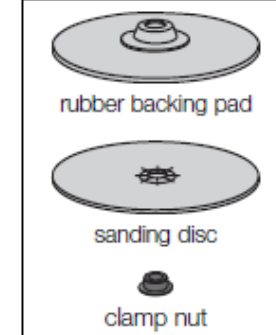
4-1/2" (115 mm) Grinding Wheels**Wire Wheels****Sanding Discs****Mounting Guard**

⚠CAUTION: Guards must be used with all grinding wheels, cutting wheels, sanding flap discs, wire brushes, and wire wheels. The tool may be used without a guard only when sanding with conventional sanding discs. A Type 1 guard (intended for use with Type 1 cutting wheels and Type 27 wheels marked for cutting only) is available at extra cost from your local dealer or authorized service center. Grinding with wheels other than Type 27 and Type 29 require different accessory guards not included with the tool. A type 27 guard is provided for use with a 1/4" (6.35 mm) thick Type 27 wheel.

NOTE: Edge grinding and cutting can be performed with Type 27 wheels designed and specified for this purpose; 1/4" (6.35 mm) thick wheels are designed for surface grinding while thinner Type 27 wheels need to be examined for the manufacturer's label to see if they can be used for surface grinding or only edge grinding/cutting. A Type 1 guard must be used for any wheel where surface grinding is forbidden. Cutting can also be performed by using a Type 1 wheel and a Type 1 guard.

MOUNTING, ADJUSTING AND REMOVING (TYPE 27) ONE-TOUCH™ GUARD (FIG. 3)

Your grinder is supplied with a keyless ONE TOUCH™ guard.

1. Press the guard release lever (J).
2. While holding the guard release lever open, align the lugs (L) on the guard with the slots (M) on the gear case.
3. Keeping the guard release lever open, push the guard down until the guard lugs engage and rotate them in the groove on the gear case hub. Release the guard release lever.

4-1/2" (115 mm) Cutting Wheels

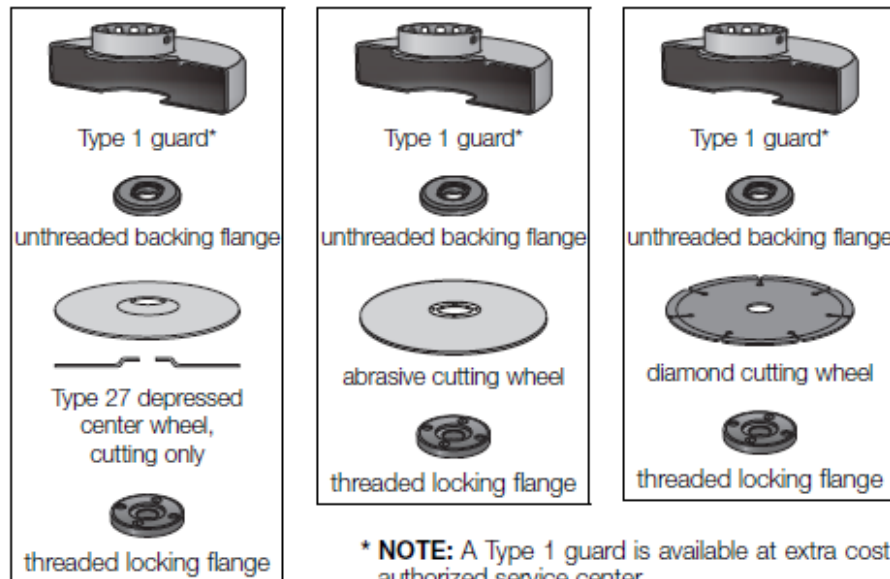

4-1/2" (115 mm) Sanding Flap Discs

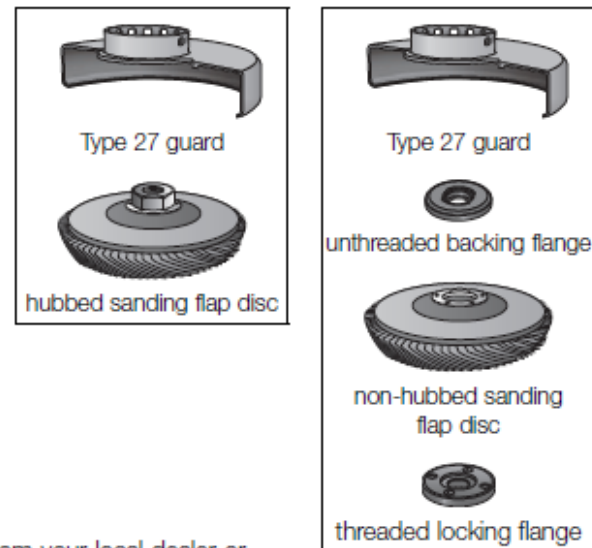

* **NOTE:** A Type 1 guard is available at extra cost from your local dealer or authorized service center.

4. With the spindle facing the operator, rotate the guard clockwise into the desired working position. The guard body should be positioned between the spindle and the operator to provide maximum operator protection.
5. For easy adjustment, the guard can be rotated in the clockwise direction. **The guard's design allows the guard to be rotated and adjusted by turning the guard in a clockwise, single action motion. The lever does not need to be depressed to turn the guard. The lever is only used for**

- removal of the guard.** The guard can be repositioned the opposite direction by depressing the guard release lever. **NOTE:** The guard release lever should snap into one of the alignment holes (N) on the guard collar. This ensures that the guard is secure.
6. To remove the guard, follow steps 1-3 of these instructions in reverse.

OPERATION

⚠ WARNING: To reduce the risk of injury, turn unit off and disconnect it from power source before making any adjustments or removing/installing attachments or accessories. An accidental start-up can cause injury.

Guards and Flanges

It is important to choose the correct guards and flanges to use with the grinder accessories. See pages 10 and 11 and this page for the correct accessories.

NOTE: Edge grinding and cutting can be performed with Type 27 wheels designed and specified for this purpose.

Switches

⚠ CAUTION: Hold the side handle and body of the tool firmly to maintain control of the tool at start up and during use and until the wheel or accessory stops rotating. Make sure the wheel has come to a complete stop before laying the tool down.

NOTE: To reduce unexpected tool movement, do not switch the tool on or off while under load conditions. Allow the grinder to run up to full speed before touching the work surface. Lift the tool from the surface before turning the tool off. Allow the tool to stop rotating before putting it down.

FIG. 3

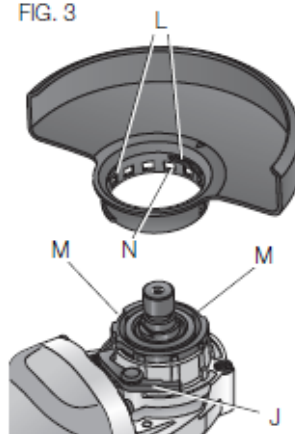

PADDLE SWITCH (FIG. 1, 4) DWE402, DWE402G

⚠ CAUTION: Before connecting the tool to a power source depress and release the paddle switch (A) once [DWE402: without depressing the lock-on button (K)] to ensure that the switch is off. Depress and release the paddle switch as described above after any interruption in power supply to the tool, such as the activation of a ground fault interrupter, throwing of a circuit breaker, accidental unplugging, or power failure. If the paddle switch is locked on, the tool will start unexpectedly when it is reconnected.

To turn the tool on, push the lock-off lever (C) toward the back of the tool, then depress the paddle switch (A). The tool will run while the switch is depressed. Turn the tool off by releasing the paddle switch.

⚠ WARNING: Do not disable the lock-off lever. If the lock-off lever is disabled, the tool may start unexpectedly when it is laid down.

FIG. 4

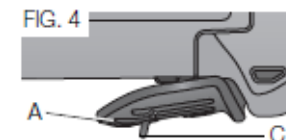

SLIDER SWITCH (FIG. 5) DWE4214

⚠ CAUTION: Before connecting the tool to a power supply, be sure the switch is in the off position by pressing the rear part of the switch and releasing. Ensure the switch is in the off position as described above after any interruption in power supply to the tool, such as the activation of a ground fault interrupter, throwing of a circuit breaker, accidental unplugging, or power failure. If the switch is locked on when the power is connected, the tool will start unexpectedly.

To start the tool, slide the ON/OFF switch (B) toward the front of the tool by pressing on the rear most part of the switch. To stop the tool, release the ON/OFF switch.

For continuous operation, slide the switch (B) toward the front of the tool and press the forward part of the switch inward. To stop the tool while operating in continuous mode, press the rear part of the switch and release.

LOCK-ON BUTTON (FIG. 6) DWE402, DWE402G

The lock-on button (K) offers increased comfort in extended use applications. To lock the tool on, push the lock-off lever (C) toward the back of the tool then depress the paddle switch (A). With the tool running, depress the lock-on button (K). The tool will continue to run after the paddle switch is released. To unlock the tool, depress and release the paddle switch. This will cause the tool to stop.

⚠ CAUTION: Allow the tool to reach full speed before touching tool to the work surface. Lift the tool from the work surface before turning the tool off.

SPINDLE LOCK BUTTON (FIG. 7)

The spindle lock button (D) is provided to prevent the spindle from rotating when installing or removing wheels. Operate the spindle lock button only when the tool is turned off, the tool is unplugged, and the wheel has come to a complete stop.

FIG. 5

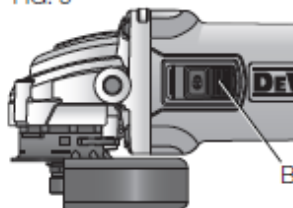

FIG. 6

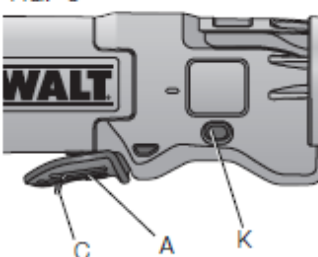

FIG. 7



NOTICE: To reduce the risk of damage to the tool, do not engage the spindle lock button while the tool is operating. Damage to the tool will result and attached accessory may spin off possibly resulting in injury.

To engage the lock, depress the spindle lock button (D) and rotate the spindle until you are unable to rotate the spindle further.

Mounting and Using Depressed Center Grinding Wheels, Sanding Flap Discs and Hubbed Wheels

⚠ CAUTION: Always use the correct guard per the instructions in this manual.

MOUNTING NON-HUBBED WHEELS (FIG. 8, 9)

Depressed center Type 27 and Type 42 grinding wheels must be used with included flanges. See pages 10 and 11 of this manual for more information.

1. Install the unthreaded backing flange (G) on spindle (E) with the raised section (pilot) against the wheel. Be sure the backing flange recess is seated onto the flats of the spindle by pushing and twisting the flange before placing wheel.
2. Place wheel against the backing flange, centering the wheel on the raised section (pilot) of the backing flange.

FIG. 8

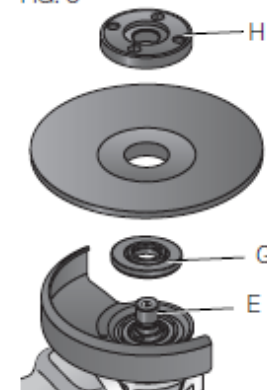

3. While depressing the spindle lock button, thread the locking flange (H) on spindle. If the wheel you are installing is more than 1/8" (3.17 mm) thick, place the threaded locking flange on the spindle so that the raised section (pilot) fits into the center of the wheel. If the wheel you are installing is 1/8" (3.17 mm) thick or less, place the threaded locking flange on the spindle so that the raised section (pilot) is not against the wheel.
4. While depressing the spindle lock button, tighten the locking flange with a wrench.
5. To remove the wheel, depress the spindle lock button and loosen the threaded locking flange with a wrench.

NOTE: If the wheel spins after the threaded locking flange is tightened, check the orientation of the threaded locking flange. If a thin wheel is installed with the pilot on the locking flange against the wheel, it will spin because the height of the pilot prevents the locking flange from holding the wheel.

FIG. 9

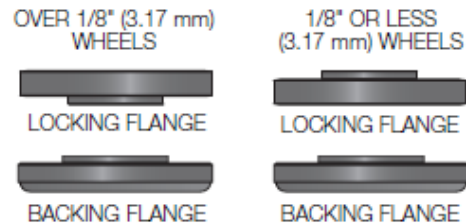

SURFACE GRINDING WITH GRINDING WHEELS (FIG. 10)

1. Allow the tool to reach full speed before touching the tool to the work surface.
2. Apply minimum pressure to the work surface, allowing the tool to operate at high speed. Grinding rate is greatest when the tool operates at high speed.

3. Maintain a 20° to 30° angle between the tool and work surface.
4. Continuously move the tool in a forward and back motion to avoid creating gouges in the work surface.
5. Remove the tool from work surface before turning tool off. Allow the tool to stop rotating before laying it down.

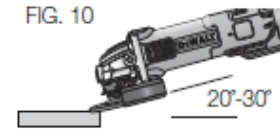

FIG. 10

EDGE GRINDING WITH GRINDING WHEELS (FIG. 11)

CAUTION: Wheels used for edge grinding and cutting may break or kick back if they bend or twist while the tool is being used. In all edge grinding/cutting operations, the open side of the guard must be positioned away from the operator. Edge grinding/cutting with a Type 27 wheel must be limited to shallow cutting and notching—less than 1/2" (13 mm) in depth when the wheel is new. Reduce the depth of cutting/notching equal to the reduction of the wheel radius as it wears down. Refer to pages 10 and 11 for more information. Edge grinding/cutting with a Type 1 wheel requires usage of a Type 1 guard.

1. Allow the tool to reach full speed before touching the tool to the work surface.
2. Apply minimum pressure to the work surface, allowing the tool to operate at high speed. Grinding rate is greatest when the tool operates at high speed.
3. Position yourself so that the open-underside of the wheel is facing away from you.
4. Once a cut is begun and a notch is established in the workpiece, do not change the angle of the cut. Changing

FIG. 11

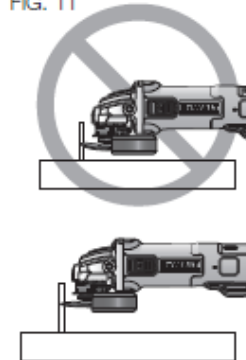

the angle will cause the wheel to bend and may cause wheel breakage. Edge grinding wheels are not designed to withstand side pressures caused by bending.

5. Remove the tool from the work surface before turning the tool off. Allow the tool to stop rotating before laying it down.

⚠WARNING: Do not use edge grinding/cutting wheels for surface grinding applications if the wheel label has forbidden such use because these wheels are not designed for side pressures encountered with surface grinding. Wheel breakage and serious personal injury may result.

SURFACE FINISHING WITH SANDING FLAP DISCS (FIG. 12)

1. Allow the tool to reach full speed before touching the tool to the work surface.
2. Apply minimum pressure to work surface, allowing the tool to operate at high speed. Sanding rate is greatest when the tool operates at high speed.
3. Maintain a 5° to 10° angle between the tool and work surface.
4. Continuously move the tool in a forward and back motion to avoid creating gouges in the work surface.
5. Remove the tool from work surface before turning tool off. Allow the tool to stop rotating before laying it down.

FIG. 12

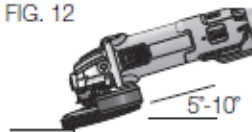

MOUNTING SANDING BACKING PADS (FIG. 1, 13)

NOTE: Use of a guard with sanding discs that use backing pads, often called fiber resin discs, is not required. Since a guard is not required for these accessories, the guard may or may not fit correctly if used.

⚠WARNING: Proper guard must be reinstalled for grinding wheel, cutting wheel, sanding flap disc, wire brush or wire wheel applications after sanding applications are complete.

1. Place or appropriately thread backing pad (O) on the spindle.
2. Place the sanding disc (P) on the backing pad (O).
3. While depressing spindle lock (D), thread clamp nut (Q) on spindle, piloting the raised hub on the clamp and backing pad.
4. Tighten the clamp nut by hand. Then depress the spindle lock button while turning the sanding disc until the sanding disc and clamp nut are snug.
5. To remove the wheel, grasp and turn the backing pad and sanding disc while depressing the spindle lock button.

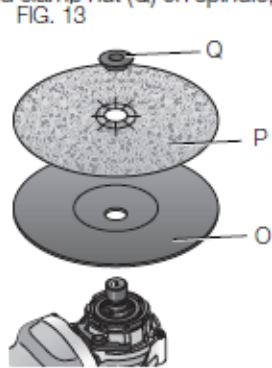

USING SANDING BACKING PADS (FIG. 14)

Choose the proper grit sanding discs for your application. Sanding discs are available in various grits. Coarse grits yield faster material removal rates and a rougher finish. Finer grits yield slower material removal and a smoother finish.

Begin with coarse grit discs for fast, rough material removal. Move to a medium grit paper and finish with a fine grit disc for optimal finish.

Coarse	16-30 grit
Medium	36-80 grit
Fine Finishing	100-120 grit
Very Fine Finishing	150-180 grit

1. Allow the tool to reach full speed before touching tool to the work surface.
2. Apply minimum pressure to work surface, allowing the tool to operate at high speed. Sanding rate is greatest when the tool operates at high speed.
3. Maintain a 5° to 15° angle between the tool and work surface. The sanding disc should contact approximately 1" (25.4 mm) of work surface.
4. Move the tool constantly in a straight line to prevent burning and swirling of work surface. Allowing the tool to rest on the work surface without moving, or moving the tool in a circular motion causes burning and swirling marks on the work surface.
5. Remove the tool from work surface before turning tool off. Allow the tool to stop rotating before laying it down.

FIG. 14

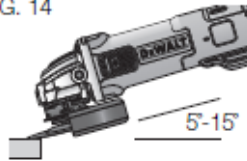

MOUNTING AND REMOVING HUBBED WHEELS (FIG. 15)

Hubbed wheels install directly on the 5/8"-11 threaded spindle. Thread of accessory must match thread of spindle.

1. Remove backing flange by pulling away from tool.
2. Thread the wheel on the spindle (E) by hand.
3. Depress the spindle lock button and use a wrench to tighten the hub of the wheel.
4. Reverse the above procedure to remove the wheel.

FIG. 15

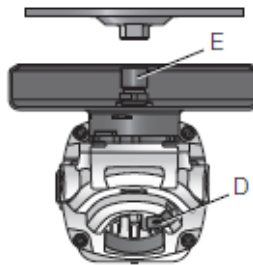

NOTICE: Failure to properly seat the wheel before turning the tool on may result in damage to the tool or the wheel.

Precautions To Take When Sanding Paint

1. Sanding of lead based paint is NOT RECOMMENDED due to the difficulty of controlling the contaminated dust. The greatest danger of lead poisoning is to children and pregnant women.
2. Since it is difficult to identify whether or not a paint contains lead without a chemical analysis, we recommend the following precautions when sanding any paint:

PERSONAL SAFETY

1. No children or pregnant women should enter the work area where the paint sanding is being done until all clean up is completed.
2. A dust mask or respirator should be worn by all persons entering the work area. The filter should be replaced daily or whenever the wearer has difficulty breathing.

NOTE: Only those dust masks suitable for working with lead paint dust and fumes should be used. Ordinary painting masks do not offer this protection. See your local hardware dealer for the proper N.I.O.S.H. approved mask.

3. NO EATING, DRINKING or SMOKING should be done in the work area to prevent ingesting contaminated paint particles. Workers should wash and clean up BEFORE eating, drinking or smoking. Articles of food, drink, or smoking should not be left in the work area where dust would settle on them.

ENVIRONMENTAL SAFETY

1. Paint should be removed in such a manner as to minimize the amount of dust generated.
2. Areas where paint removal is occurring should be sealed with plastic sheeting of 4 mils thickness.
3. Sanding should be done in a manner to reduce tracking of paint dust outside the work area.

CLEANING AND DISPOSAL

1. All surfaces in the work area should be vacuumed and thoroughly cleaned daily for the duration of the sanding project. Vacuum filter bags should be changed frequently.
2. Plastic drop cloths should be gathered up and disposed of along with any dust chips or other removal debris. They should be placed in sealed refuse receptacles and disposed of through regular trash pick-up procedures.
During clean up, children and pregnant women should be kept away from the immediate work area.
3. All toys, washable furniture and utensils used by children should be washed thoroughly before being used again.

Mounting and Using Wire Brushes and Wire Wheels

Wire cup brushes or wire wheels screw directly on the grinder spindle without the use of flanges. Use only wire brushes or wheels provided with a 5/8"-11 threaded hub. A Type 27 guard is required when using wire brushes and wheels.

⚠CAUTION: To reduce the risk of personal injury, wear work gloves when handling wire brushes and wheels. They can become sharp.

⚠CAUTION: To reduce the risk of damage to the tool, wheel or brush must not touch guard when mounted or while in use. Undetectable damage could occur to the accessory, causing wires to fragment from accessory wheel or cup.

MOUNTING WIRE CUP BRUSHES AND WIRE WHEELS

⚠WARNING: To reduce the risk of serious personal injury, turn tool off before making any adjustments or removing/installing attachments or accessories. An accidental start-up can cause injury.

1. Thread the wheel on the spindle by hand.
2. Depress spindle lock button and use a wrench on the hub of the wire wheel or brush to tighten the wheel.
3. To remove the wheel, reverse the above procedure.

NOTICE: To reduce the risk of damage to the tool, properly seat the wheel hub before turning the tool on.

USING WIRE CUP BRUSHES AND WIRE WHEELS (FIG. 16, 17)

Wire wheels and brushes can be used for removing rust, scale and paint, and for smoothing irregular surfaces.

NOTE: The same precautions should be taken when wire brushing paint as when sanding paint (refer to **Precautions To Take When Sanding Paint**).

1. Allow the tool to reach full speed before touching the tool to the work surface.
2. Apply minimum pressure to work surface, allowing the tool to operate at high speed. Material removal rate is greatest when the tool operates at high speed.
3. Maintain a 5° to 10° angle between the tool and work surface for wire cup brushes.
4. Maintain contact between the edge of the wheel and the work surface with wire wheels.

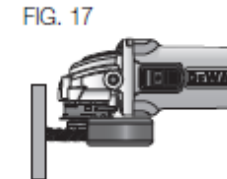
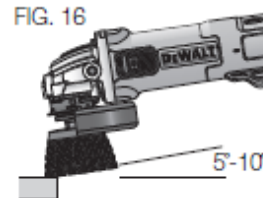

5. Continuously move the tool in a forward and back motion to avoid creating gouges in the work surface. Allowing the tool to rest on the work surface without moving, or moving the tool in a circular motion causes burning and swirling marks on the work surface.
6. Remove the tool from the work surface before turning the tool off. Allow the tool to stop rotating before setting it down.

CAUTION: Use extra care when working over an edge, as a sudden sharp movement of grinder may be experienced.

Mounting and Using Type 1/Type 41 Cutting Wheels

NOTE: The Type 1 guard MUST be used and is available at extra cost from your local dealer or authorized service center.

Cutting wheels include diamond wheels and abrasive discs. Abrasive cutting wheels for metal and concrete use are available. Diamond blades for concrete cutting can also be used.

WARNING: A closed, two-sided cutting wheel guard is required when using cutting wheels. Failure to use proper flange and guard can result in injury resulting from wheel breakage and wheel contact. See pages 10 and 11 for more information.

MOUNTING AND REMOVING (TYPE 1) ONE-TOUCH™ GUARD (FIG. 18)

Cutting wheels include diamond wheels and abrasive discs. Abrasive cutting wheels for metal and concrete use are available. Diamond blades for concrete cutting can also be used.

MOUNTING CLOSED (TYPE 1) GUARD

CAUTION: Turn off and unplug the tool before making any adjustments or removing or installing attachments or accessories. Before reconnecting the tool, depress and release the paddle switch to ensure that the tool is off.

Your grinder is supplied with a keyless ONE TOUCH™ guard.

1. Press the guard release lever (J).
2. While holding the guard release lever open, push the guard down until the guard lugs (L) on the guard with the slots (M) on the gear case.
3. Keeping the guard release lever open, push the guard down until the guard lugs engage and rotate them in the groove on the gear case hub. Release the guard release lever.
4. With the spindle facing the operator, rotate the guard clockwise into the desired working position. The guard body should be positioned between the spindle and the operator to provide maximum operator protection.
5. For easy adjustment, the guard can be rotated in the clockwise direction.
6. To remove the guard, follow steps 1–3 of these instructions in reverse.

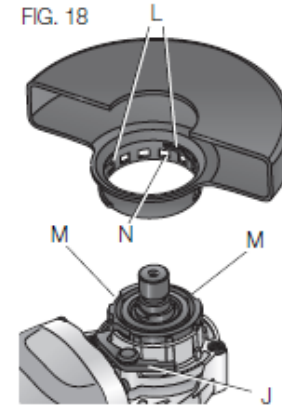

NOTE: The guard release lever should snap into one of the alignment holes (O) on the guard collar. This insures that the guard is secure. The guard can be repositioned the opposite direction by depressing the guard release lever.

6. To remove the guard, follow steps 1–3 of these instructions in reverse.

MOUNTING TYPE 1 OR TYPE 41 CUTTING WHEELS

⚠️WARNING: *To reduce the risk of serious personal injury, turn tool off before making any adjustments or removing/installing attachments or accessories. An accidental start-up can cause injury.*

⚠️CAUTION: *Matching diameter backing flange and threaded locking flange (included with tool) must be used for Type 1 and Type 41 cutting wheels.*

1. Place the unthreaded backing flange on spindle with the raised section (pilot) facing up. The raised section (pilot) on the backing flange will be against the wheel when the wheel is installed.
2. Place the wheel on the backing flange, centering the wheel on the raised section (pilot).
3. Install the threaded locking flange with the raised section (pilot) facing away from the wheel.
4. Depress the spindle lock button and tighten threaded locking flange with a wrench.
5. To remove the wheel, depress the spindle lock button and loosen the threaded locking flange with a wrench.

USING TYPE 1 OR TYPE 41 CUTTING WHEELS

⚠️WARNING: *Do not use edge grinding/cutting wheels for surface grinding applications because these wheels are not designed for side pressures encountered with surface grinding. Wheel breakage and injury may result.*

1. Allow tool to reach full speed before touching tool to work surface.
2. Apply minimum pressure to work surface, allowing tool to operate at high speed. Cutting rate is greatest when the tool operates at high speed.
3. Once a cut is begun and a notch is established in the workpiece, do not change the angle of the cut. Changing the angle will cause the wheel to bend and may cause wheel breakage.

4. Remove the tool from work surface before turning tool off. Allow the tool to stop rotating before setting it down.

MAINTENANCE

⚠️WARNING: *To reduce the risk of injury, turn unit off and disconnect it from power source before installing and removing accessories, before adjusting or when making repairs. An accidental start-up can cause injury.*

Cleaning

⚠️WARNING: *Blow dirt and dust out of all air vents with clean, dry air at least once a week. To minimize the risk of eye injury, always wear ANSI Z87.1 approved eye protection when performing this.*

⚠️WARNING: *Never use solvents or other harsh chemicals for cleaning the non-metallic parts of the tool. These chemicals may weaken the plastic materials used in these parts. Use a cloth dampened only with water and mild soap. Never let any liquid get inside the tool; never immerse any part of the tool into a liquid.*

Accessories

⚠️WARNING: *Since accessories, other than those offered by DEWALT, have not been tested with this product, use of such accessories with this tool could be hazardous. To reduce the risk of injury, only DEWALT recommended accessories should be used with this product.*

Recommended accessories for use with your tool are available at extra cost from your local dealer or authorized service center. If you need assistance in locating any accessory, please contact DEWALT Industrial Tool Co., 701 East Joppa Road, Baltimore, MD 21286, call 1-800-4-DEWALT (1-800-433-9258) or visit our website: www.dewalt.com.

Repairs

To assure product SAFETY and RELIABILITY, repairs, maintenance and adjustment (including brush inspection and replacement) should be performed by a DeWALT factory service center, a DeWALT authorized service center or other qualified service personnel. Always use identical replacement parts.

Register Online

Thank you for your purchase. Register your product now for:

- **WARRANTY SERVICE:** Registering your product will help you obtain more efficient warranty service in case there is a problem with your product.
- **CONFIRMATION OF OWNERSHIP:** In case of an insurance loss, such as fire, flood or theft, your registration of ownership will serve as your proof of purchase.
- **FOR YOUR SAFETY:** Registering your product will allow us to contact you in the unlikely event a safety notification is required under the Federal Consumer Safety Act.

Register online at www.dewalt.com/register.

Three Year Limited Warranty

DeWALT will repair, without charge, any defects due to faulty materials or workmanship for three years from the date of purchase. This warranty does not cover part failure due to normal wear or tool abuse. For further detail of warranty coverage and warranty repair information, visit www.dewalt.com or call 1-800-4-DeWALT (1-800-433-9258). This warranty does not apply to accessories or damage caused where repairs have been made or attempted by others. This warranty gives you specific legal rights and you may have other rights which vary in certain states or provinces.

In addition to the warranty, DeWALT tools are covered by our:

1 YEAR FREE SERVICE

DeWALT will maintain the tool and replace worn parts caused by normal use, for free, any time during the first year after purchase.

90 DAY MONEY BACK GUARANTEE

If you are not completely satisfied with the performance of your DeWALT Power Tool, Laser, or Nailer for any reason, you can return it within 90 days from the date of purchase with a receipt for a full refund – no questions asked.

LATIN AMERICA: This warranty does not apply to products sold in Latin America. For products sold in Latin America, see country specific warranty information contained in the packaging, call the local company or see website for warranty information.

FREE WARNING LABEL REPLACEMENT: If your warning labels become illegible or are missing, call 1-800-4-DeWALT (1-800-433-9258) for a free replacement.



DEWALT Industrial Tool Co., 701 East Joppa Road, Baltimore, MD 21286

(SEP14) Part No. N382909 DWE402, DWE402N, DWE402G, DWE4214 Copyright © 2014 DeWALT

The following are trademarks for one or more DEWALT power tools: the yellow and black color scheme; the "D" shaped air intake grill; the array of pyramids on the handgrip; the kit box configuration; and the array of lozenge-shaped humps on the surface of the tool.

