

CHAMPION
GLOBAL POWER EQUIPMENT

Installation Manual

Home Standby Generator

8.5 kW

MODEL NUMBER 100199



CALIFORNIA PROPOSITION 65 WARNING

Certain components in this product and its related accessories contain chemicals known to the state of California to cause cancer, birth defects or other reproductive harm. Wash hands after handling.

CALIFORNIA PROPOSITION 65 WARNING

The engine exhaust from this product contains chemicals known to the state of California to cause cancer, birth defects or other reproductive harm.

DISCLAIMERS

All information, illustrations and specifications in this manual are based on the latest information available at the time of publishing. The illustrations used in this manual are intended as representative reference views only. Products are under a continuous improvement policy. Thus, information, illustrations and/or specifications to explain and/or exemplify a product, service or maintenance improvement may be changed at any time without notice.

ALL RIGHTS RESERVED

No part of this publication may be reproduced or used in any form by any means – graphic, electronic or mechanical, including photocopying, recording, taping or information storage and retrieval systems – without the written permission of Champion Power Equipment (CPE).

Have questions or need assistance?

Do not return this product to the store!

WE ARE HERE TO HELP!

Visit our website:

www.championpowerequipment.com

for more info:

- Product Info & Updates
- Tech Bulletins
- Frequently Asked Questions
- Product Registration

– or –

Call our Customer Care Team Toll-Free at:

1-877-338-0999

*We are always working to improve our products. Therefore, the enclosed product may differ slightly from the image on the cover.



CONTENTS

INTRODUCTION5

- Home standby generator5
- Parts Included5
- HSB Models6
- Standard Features Tailor-Made Solutions6
- General Information, Standards and Codes7

SAFETY8

- Safety Symbol Definitions8
- Installation Hazards.9
- Before Starting10
- Operating Hazards10
- Accidental Starting11
- Carbon Monoxide Hazards.11
- Electrical Shock Hazards12
- Fire/Explosion Hazards12
- Burn Hazards13
- Entanglement Hazards13
- Battery Hazards13
- Safety Labels13
 - Safety Labels on Unit 14
 - Safety, Serial/Model, Nameplate Label Locations . . . 15
- Placement and Installation Guidelines for
Champion 8,5kW Home Standby Generator
to Reduce the Risk of Fire16
 - National Fire Protection Association (NFPA)
Standard NFPA 37 Requirements and Testing. 16
- YF Power Technology Co. Ltd. Decal.17

SPECIFICATIONS18

- Champion 439CC Engine19
- Champion 439CC Engine Torque Specifications . . 19

- Master Mixing Assembly Jets
(Carburetor System)19
- Alternator Overview20
- Rotor Assembly20
- Stator Assembly20
- Brush Holder and Brushes.20

UNPACKING21

INSTALLATION22

- Generating Sizing22
- Site Selection, Preparation and Placement22
 - Site Selection. 22
 - Preparation 23
 - Placement 24
- Installation Preparation25
 - Fuel Requirements and Recommendations. 25
 - Fuel Consumption 26
 - NG Pipe Sizing 26
 - LPG Vapor Pipe Sizing 28
 - Converting to LPG 29
 - Full Fuel Shut Off 30
 - Sediment Trap 30
 - Checking Pressure with a Manometer 30
 - Battery Requirements, Installation & Service 31
- Flexible Fuel Line33
- Wire Sizing.33
- Identify/Select Standby Circuits34
- Surge Protection.34
- Hour Meter and Over Voltage Protection.34
 - Hour Meter 34

CONTENTS



Over Voltage Protection 34

Set Exercise Time 35

AVR=Automatic Voltage Regulator 35

Engine Relay Modul 36

 Top Row 36

 Bottom Row 36

Engine Controller 37

 Mode Switch 37

 Pin Locations 39

ATS Control Module 39

 Test/Auto/Off Switch 40

 Pin Locations 40

Battery Charger 41

HSB Test 42

 Voltage Checks- No Load 42

 HSB Test Under Load 43

Checking Automatic Operation 44

Customer Familiarization Summary 44

HSB, ATS Model & Serial Reference

ATS Back-Up Circuits 46

Automatic Transfer Switch 47

 Unpacking 47

 Location and Mounting 47

 Circuit Breakers for Utility

 Main Control Panel and ATS 47

 Electrical Grommet(s) 48

 Installation Wiring for ATS

 to Utility Main Control Panel 48

 Installing Communication Wires 49

 Commissioning the ATS 49

ATS Circuit Board Fuse Information 50

ATS Fuse Troubleshooting and Testing 50

Fuses F2 and F3 50

Fuses F4 and F5 50

Fuse F1 50

Fuse F6 51

Manual Transfer Switch 51

TROUBLESHOOTING HSB 52

This manual must be used with Champion Power Equipment (CPE) manuals:

- Operation Manual, Part No. 101048
- Transfer Switch Manual, Part No. 101111

It is also recommended to refer to the reference materials on page 7 of this manual.

Congratulations on your purchase of a Champion Power Equipment (CPE) home standby generator. This generator is designed and engineered in the USA to exacting standards of the North American market. This engine-powered generator meets all Environmental Protection Agency (EPA) Phase 3 requirements and is approved by cETLus as tested to UL2200 and CSA22.2 No. 100 in both the USA and Canada.

With proper use and maintenance, this generator will provide years of satisfying service.

The Champion Staff,

Champion Power Equipment
12039 Smith Ave.
Santa Fe Springs, CA 90670

Toll-free: 1-877-338-0999
Mon-Fri 8:30 AM – 5:00 PM (PST/PDT)
www.championpowerequipment.com
tech@championpowerequipment.com

HOME STANDBY GENERATOR

This home standby generator is intended exclusively for outdoor installation. This generator will operate using either liquefied petroleum gas (LPG, Propane) or natural gas (NG).

This generator is designed to supply typical home load such as:

- Induction motors – sump pumps, refrigerators, air conditioners, furnaces
- Electronic items – televisions, computers
- Household lighting
- Microwaves
- This generator is not intended for use in critical life support applications.

Proper sizing of the generator is required to ensure proper operation of appliances. Some appliances require additional wattage to start and must be considered.

PARTS INCLUDED

Your HSB ships with the following:

- Operators Manual
- Installation Manual
- Oil Drain Pan
- Flexible Fuel Line
- HSB Enclosure Keys
- Battery Cable Connection
- LPG Low-speed and Main Converting Jets
- Jet Change Tool
- Lock Nut M6
- Washer, Ø6
- Flange bolt, M6 x 15

INTRODUCTION

HSB MODELS

100199 8.5kW HSB Generator Only

100947 ATS Only 50A NEMA 1 (non-pre-wired switch)

100950 ATS Only 50A ATS NEMA 3R (non-pre-wired switch)

100174 8.5kW HSB & 50A ATS NEMA 1 (non-pre-wired switch)

100177 8.5kW HSB & 50A ATS NEMA 3R (non-pre-wired switch)

STANDARD FEATURES, TAILOR-MADE SOLUTIONS

- : Tested and approved by CARB, EPA and UL in both USA and Canada
- : HSB Designed and Engineered in the USA by Champion
- : Milwaukee Series Engine, Designed and Engineered in USA by Champion
- : 5 year, 2000 hour limited warranty
- : Easy access, all weather steel, sound attenuated enclosure, Gull Wing door design, quiet operation
- : Composite Mounting Pad, eliminates the need of concrete pad unless required by code
- : Natural Gas (NG) or LP gas (propane) operation
- : Exterior LED fault light (turns on if unit controller detects a fault code)
- : Automatic weekly exercise, operates engine and generator between outage events, system check
- : On board battery charging and monitoring, digital LED controller
- : Engine and Generator monitoring, digital LED controller
- : Fast/Tran ATS (automatic transfer switch), safe and simple, extremely high speed switching system
- : Flexible fuel line connector, absorbs vibration when connected to rigid piping

Champion Power Equipment is a market leader in power generation equipment. Champion has years of experience designing and manufacturing dependable and durable power products designed and engineered in the US to the exacting standards of the North American market. All our residential standby products are designed in conformance with Environmental Protection Agency (EPA) requirements, California Air Resource Board (CARB) regulations and are approved by Underwriters Laboratory (UL) in both the USA and Canada. When the power goes out you'll want a Champion by your side.

GENERAL INFORMATION, STANDARDS AND CODES

The following information related to General Information and Standards was gathered from the list of publications related to installing the HSB generator. A multitude of other materials related to generators were also used concerning common practice, knowledgeable installation practices, certified electrical experience and work related experiences. This information is not all inclusive and the manufacturer strongly recommends the owner and installer become familiar with all pertinent codes, standards and regulations. Always check for the latest publications date to ensure you are current. Have only a qualified/certified electrician or installation technician who is knowledgeable about applicable codes, standards and regulations install and service the generator.

NFPA NO. 30, FLAMMABLE AND COMBUSTIBLE LIQUID CODE

National Fire Protection Association

470 Atlantic Avenue, Boston, MA. 02210

NFPA NO. 37, STATIONARY COMBUSTION ENGINES AND GAS TURBINES

National Fire Protection Association

470 Atlantic Avenue, Boston, Ma. 02210

NFPA NO. 76A, ESSENTIAL ELECTRICAL SYSTEMS FOR HEALTH CARE FACILITIES

National Fire Protection Association

470 Atlantic Avenue, Boston, Ma. 02210

NFPA NO. 54, NATIONAL FUEL GAS CODE

National Fire Protection Association

470 Atlantic Avenue, Boston, Ma. 02210

NFPA NO. 58, AMERICAN NATIONAL STANDARD FOR STORAGE AND HANDLING OF LIQUID PETROLEUM GAS

National Fire Protection Association

470 Atlantic Avenue, Boston, Ma. 02210

NFPA NO. 70, NFPA HANDBOOK OF ELECTRIC CODE

National Fire Protection Association

470 Atlantic Avenue, Boston, Ma. 02210

ARTICLE X, NATIONAL BUILDING CODE

American Insurance Association

85 John Street, New York, N.Y. 10038

AGRICULTURAL WIRING HANDBOOK

Food and Energy Council

909 University Avenue, Columbia, Mo. 65201

ASAE EP-3634, INSTALLATION AND MAINTENANCE OF FARM STANDBY ELECTRICAL SYSTEMS

American Society of Agricultural Engineers

2950 Niles Road, St. Joseph, Mi. 49085

SAFETY



This is the safety alert symbol. It is used to alert you to potential physical injury hazards. Obey all safety messages that follow this symbol to avoid possible injury or death.

The words DANGER, WARNING, CAUTION and NOTICE are used throughout this manual to highlight important information.



DANGER

Indicates a hazardous situation that, if not avoided, will result in death or serious injury.



WARNING

Indicates a hazardous situation that, if not avoided, could result in death or serious injury.



CAUTION



Indicates a hazardous situation that, if not avoided, could result in minor or moderate injury.

NOTICE

Indicates a situation that can cause damage to the equipment, personal property and/or the environment, or cause the equipment to operate improperly.



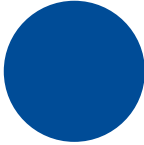

NOTE: Indicates a procedure, practice or condition that should be followed in order for the generator to function in the manner intended.

SAFETY SYMBOL DEFINITIONS

	Black hazard pictorial on yellow equilateral triangle enclosed by black triangular band Warns that hazard exists and describes its nature and/or consequences
	Black hazard pictorial on white circle enclosed by red circular band with red diagonal bar Depicts action NOT to be taken or action to be stopped in order to avoid hazard
	White hazard pictorial on blue circle Depicts action to be taken in order to avoid hazard

/// WARNINGS

	Safety alert symbol
	Asphyxiation hazard
	Electrical shock hazard
	Entanglement hazard
	Fire hazard

	Explosion hazard
	Burn hazard
	Sever hazard (rotating blade)
	Crush hazard (top)

/// MANDATORY ACTIONS

	Read manufacturer's instructions
	Wear eye protection
	Wear personal protective equipment
	Do not leave tools in the area

INSTALLATION HAZARDS

 **WARNING**

 Have only a qualified electrician or installation technician who is familiar with applicable codes, standards and regulations install and service the generator.

ALWAYS comply with local, state and national electrical and building codes when installing the generator. **NEVER** alter the recommended installation in a way that would render the unit noncompliant with these codes.

ALWAYS comply with regulations that Occupational Safety and Health Administration (OSHA) has established.

ENSURE the generator is installed following the manufacturer's instructions.

NOTICE

Before welding components on the generator, contact CPE for recommended welding instructions.

 **WARNING**

 **Not intended for use in critical life support applications.**

SAFETY

BEFORE STARTING

CAUTION



Before starting, operating and maintaining this generator, be sure to read and understand the content and safety messages in this manual. The operator is responsible for safe operation and maintenance of the generator. Be sure all potential users of the generator also understand these instructions. If any portion of this manual is not understood, contact your dealer for assistance before operating the generator.

The operator is responsible for performing all safety checks, making sure all maintenance is properly performed and making sure the generator is periodically checked by the dealer.

Inspect the generator regularly. Contact your dealer if repairs are needed.

NEVER climb or step on any part or components of the generator. Doing so may result in injury and cause leaking fuel and exhaust.

OPERATING HAZARDS

WARNING



ALWAYS operate the generator following the manufacturer's instructions. Operating the generator imprudently, neglecting maintenance or being careless can result in injury or possible death.

DO NOT allow children or unqualified persons to operate or service the generator.

NEVER operate the generator with the covers open. Operate the generator only with the covers closed and secured in place. NEVER leave the covers unlocked.

Remain alert at all times when working on the generator. NEVER work on the generator when physically or mentally fatigued.

Never operate the generator while under the influence of alcohol or drugs. Their effects on vision and judgment make operating a generator dangerous.

ACCIDENTAL STARTING

WARNING



ALWAYS prevent the generator from starting while the covers are open. The generator may crank and start at any time without notice. Follow these steps in order:



1. Turn the exercise switch to the OFF position.

2. Switch the main circuit breaker to the OFF position.



3. Turn the ATS control module to the OFF position.

4. Turn the engine control module switch to the OFF position.

5. Disconnect the NEGATIVE, NEG or (-) battery cable first, and then remove the POSITIVE, POS or (+) battery cable.

To return the generator to service, follow these steps in order:

1. Connect the POSITIVE, POS or (+) battery cable first, and then connect the NEGATIVE, NEG or (-) battery cable.

2. Turn the engine control module switch to the ATS position.

3. Turn the ATS control module switch to the AUTO position.

4. Switch the main circuit breaker to the ON position.

5. Turn the exercise switch to the ON position at desired exercise time.

CARBON MONOXIDE HAZARDS

DANGER



Generator exhaust contains carbon monoxide, a colorless, odorless, poisonous gas. Breathing carbon monoxide will cause nausea, dizziness, fainting or death. If you start to feel dizzy or weak, get to fresh air immediately.

- The generator must be installed and operated outdoors only. NEVER install the generator where exhaust fumes could seep inside or be drawn into a potentially occupied building through windows, air intake vents or other openings.
- Avoid breathing exhaust fumes when near an operating generator.
- NEVER alter or add to the exhaust system or do anything that might render the system unsafe or in noncompliance with applicable codes, standards, laws and regulations.
- Install a battery-operated carbon monoxide detector on each level of any building adjacent to the generator following the manufacturer's instructions.
- NEVER permit even partial blockage of engine cooling ventilation air. Doing so can seriously affect safe operation of the generator.

Carbon monoxide poisoning symptoms include but are not limited to the following:

- Light-headedness, dizziness
- Physical fatigue, weakness in joints and muscles
- Sleepiness, mental fatigue, inability to concentrate or speak clearly, blurred vision
- Stomachache, vomiting, nausea

SAFETY

Carbon monoxide poisoning is possible if someone is experiencing any of these symptoms. Seek fresh air immediately. DO NOT sit, lie down or fall asleep. Alert others to the possibility of carbon monoxide poisoning. If the affected person does not improve within minutes of breathing fresh air, call 911 immediately.

ELECTRICAL SHOCK HAZARDS

WARNING



Use extreme caution when near the generator while it is operating. The generator produces dangerous voltage.

- Avoid contact with bare wires, terminals and connections while the generator is operating.
- ALWAYS stand on an insulated dry surface to reduce shock hazard if work must be done on an operating generator.
- NEVER wear jewelry that can conduct electricity when working on the generator.
- NEVER handle any kind of electrical device while hands or feet are wet, while standing in water or while barefoot.
- Proper earth grounding of the frame and external electrical conductive components is required by the National Electrical Code (NEC). State and local codes for proper grounding may also apply.
- Avoid direct contact with an electric shock victim. Immediately shut down the source of electrical power. If this is not possible, attempt to free the victim from the live conductor using a nonconducting item such as a dry board or rope. If the victim is unconscious, apply first aid and call 911 immediately.

FIRE/EXPLOSION HAZARDS

WARNING



NG and LPG are extremely explosive.

- NEVER allow any flames or smoke near the fuel system.
- Wipe up any oil spills immediately.
- NEVER allow any combustible materials to be near the generator or to be left in the generator compartment.
- ALWAYS keep the surrounding area near the generator clean and free of debris.
- Be sure to properly purge the fuel lines and leak-test according to applicable codes before placing the generator in service.
- Be sure to regularly inspect the fuel system for leaks. NEVER operate the generator if a fuel leak is present.
- Install a fire extinguisher near the generator. Keep it properly charged and be familiar with its use. An ABC rated National Fire Protection extinguisher is appropriate for use on standby electric systems. Contact your local fire department with any questions concerning the fire extinguisher.



BURN HAZARDS

WARNING



ALWAYS allow hot surfaces to cool to the touch. Running engines produce heat. Severe burns can occur on contact.

- DO NOT touch hot surfaces.
- Avoid contact with hot exhaust components and gases.

ENTANGLEMENT HAZARDS

WARNING



Use extreme caution when near rotating parts. Rotating parts can entangle hands, feet, hair, clothing and/or accessories. Traumatic amputation or severe laceration can result.

- Keep hands and feet away from rotating parts.
- Tie up long hair and remove jewelry.
- Operate equipment with guards in place.
- DO NOT wear loose-fitting clothing, dangling drawstrings or items that could become caught.

BATTERY HAZARDS

WARNING



Always read and comply with the battery manufacturer's recommendations for procedures concerning proper battery use and maintenance.

WARNING



Batteries contain sulfuric acid and generate explosive mixtures of hydrogen and oxygen gases. Keep any device that may cause sparks or flames away from the battery to prevent explosion.



Always wear protective glasses or goggles and protective clothing when working with batteries. You must follow the battery manufacturer's instructions on safety, maintenance and installation procedures.

SAFETY LABELS

WARNING



All safety labels must be legible to alert personnel of safety hazards.

- Replace any illegible or missing label immediately. Missing safety labels must be replaced in their original position before the generator is operated.
- DO NOT operate the generator if there are missing or badly worn safety labels.

SAFETY

/// SAFETY LABELS ON UNIT

①	⚠ WARNING!	⚠ CAUTION!	⚠ WARNING!
Poisonous Gas Hazard Generator exhaust contains carbon monoxide. Breathing carbon monoxide will cause nausea, dizziness, and fainting, and it may cause death.	Burn Hazard DO NOT touch hot surfaces. Avoid contact with exhaust components and gases.	Fire Hazard ALWAYS keep the surrounding area near generator clean and free of debris and/or dry vegetation. The generator may create sparks while operating.	
⚠ AVERTISSEMENT!	⚠ ATTENTION!	⚠ AVERTISSEMENT!	
Risque d'empoisonnement par le gaz Les gaz d'échappement de groupe électrogène contiennent du monoxyde de carbone. Si l'on respire du monoxyde de carbone, ceci peut provoquer des nausées, un évanouissement et une perte de conscience, et ceci peut provoquer la mort.	Risque de brûlure NE touchez PAS les surfaces chaudes. Evitez le contact avec les composants et les gaz d'échappement.	Risque d'incendie Nettoyez TOUJOURS la surface à proximité du groupe électrogène et enlevez les débris et/ou la végétation sèche. Le groupe électrogène peut générer des étincelles pendant son fonctionnement.	
⚠ ¡ADVERTENCIA!	⚠ PRECAUCIÓN!	⚠ ¡ADVERTENCIA!	
Riesgo de gas venenoso El escape del generador contiene monóxido de carbono. Aspirar monóxido de carbono causará náuseas, mareos, desvanecimiento y hasta la muerte.	Riesgo de quemaduras NO toque las superficies calientes. Evite el contacto con los componentes de escape y gases.	Riesgo de incendio SIEMPRE mantenga el área circundante cerca del generador limpia y libre de escombros y/o vegetación seca. El generador puede crear chispas mientras está en funcionamiento.	

101500

②	⚠ CAUTION!
Burn Hazard DO NOT touch hot surfaces. Allow the engine and alternator to cool to the touch before servicing.	
⚠ ATTENTION!	
Danger de brûlure NE TOUCHEZ PAS les surfaces chaudes. Laissez le moteur et l'alternateur devenir froid au toucher avant d'intervenir.	
⚠ PRECAUCIÓN!	
Riesgo de quemaduras NO toque las superficies calientes. Deje que el motor y el alternador se enfríen para tocarlos antes de realizarles el mantenimiento.	

100794

③	⚠ WARNING!
Electrical Shock Hazard Do not remove this access panel. The panel should only be removed by an authorized Service Dealer or a qualified electrician; high voltage inside.	
⚠ AVERTISSEMENT!	
Risque de choc électrique N'enlevez pas ce panneau d'accès. Le panneau ne devrait être enlevé que par un concessionnaire d'entretien agréé ou un électricien qualifié ; haute tension à l'intérieur.	
⚠ ¡ADVERTENCIA!	
Riesgo de descarga eléctrica No remueva este tablero de acceso. El tablero sólo deberá ser removido por un distribuidor de servicio autorizado o un electricista calificado; alto voltaje al interior.	

101045

④	⚠ CAUTION!
Burn Hazard DO NOT touch hot surfaces. Avoid contact with exhaust components and gases.	
⚠ ATTENTION!	
Risque de brûlure NE touchez PAS les surfaces chaudes. Evitez le contact avec les composants et les gaz d'échappement.	
⚠ PRECAUCIÓN!	
Riesgo de quemaduras NO toque las superficies calientes. Evite el contacto con los componentes de escape y gases.	

101051

⑤	⚠ WARNING!
Electrical Shock Hazard ALWAYS close and lock generator covers before operating. The generator produces dangerous voltage.	
⚠ AVERTISSEMENT!	
Risque de choc électrique Fermez et verrouillez TOUJOURS les capots de groupe électrogène avant d'utiliser le groupe. Le groupe électrogène génère des tensions dangereuses.	
⚠ ¡ADVERTENCIA!	
Riesgo de descarga eléctrica SIEMPRE cierre y trabaje las tapas del generador antes de ponerlo en funcionamiento. El generador produce un voltaje peligroso.	

100789

⑥	⚠ WARNING!	⚠ WARNING!	⚠ WARNING!
Explosion Hazard Battery gases are explosive. Keep sparks and flames away from the battery compartment.	Read Operator's Manual Read, understand and follow all safety messages in Installation and Operator's manuals.	Starting Hazard The generator may crank and start at any time without notice. Prevent the generator from starting while the covers are open. See the safety section of the operator's manual for further detail.	
⚠ AVERTISSEMENT!	⚠ AVERTISSEMENT!	⚠ AVERTISSEMENT!	
Risque d'explosion Les gaz dégagés par la batterie peuvent exploser. Écartez les étincelles et les flammes du compartiment batterie.	Lisez le manuel d'utilisation Lisez, comprenez bien et respectez tous les messages de sécurité dans les manuels d'installation et d'utilisation.	Risque au démarrage Le groupe électrogène peut tourner et démarrer à tout moment sans préavis. Ne démarrez pas le groupe électrogène lorsque les capots sont ouverts. Consultez la section sécurité du manuel d'utilisation pour plus de détail.	
⚠ ¡ADVERTENCIA!	⚠ ¡ADVERTENCIA!	⚠ ¡ADVERTENCIA!	
Riesgo de explosión Los gases de las baterías son explosivos. Mantenga las chispas y llamas alejadas del compartimento de las baterías.	Lea el manual del operador Lea, comprenda y siga todos los mensajes de seguridad en los manuales de instalación y del operador.	Riesgo de inicio El generador puede encenderse y ponerse en marcha en cualquier momento sin previo aviso. Evite que el generador se ponga en marcha mientras las tapas están abiertas. Vea la sección de seguridad en el manual del operador para más detalles.	

101499

/// SAFETY, SERIAL/MODEL, NAMEPLATE LABEL LOCATIONS

The safety labels have specific placement and must be replaced if they are unreadable, damaged or missing.

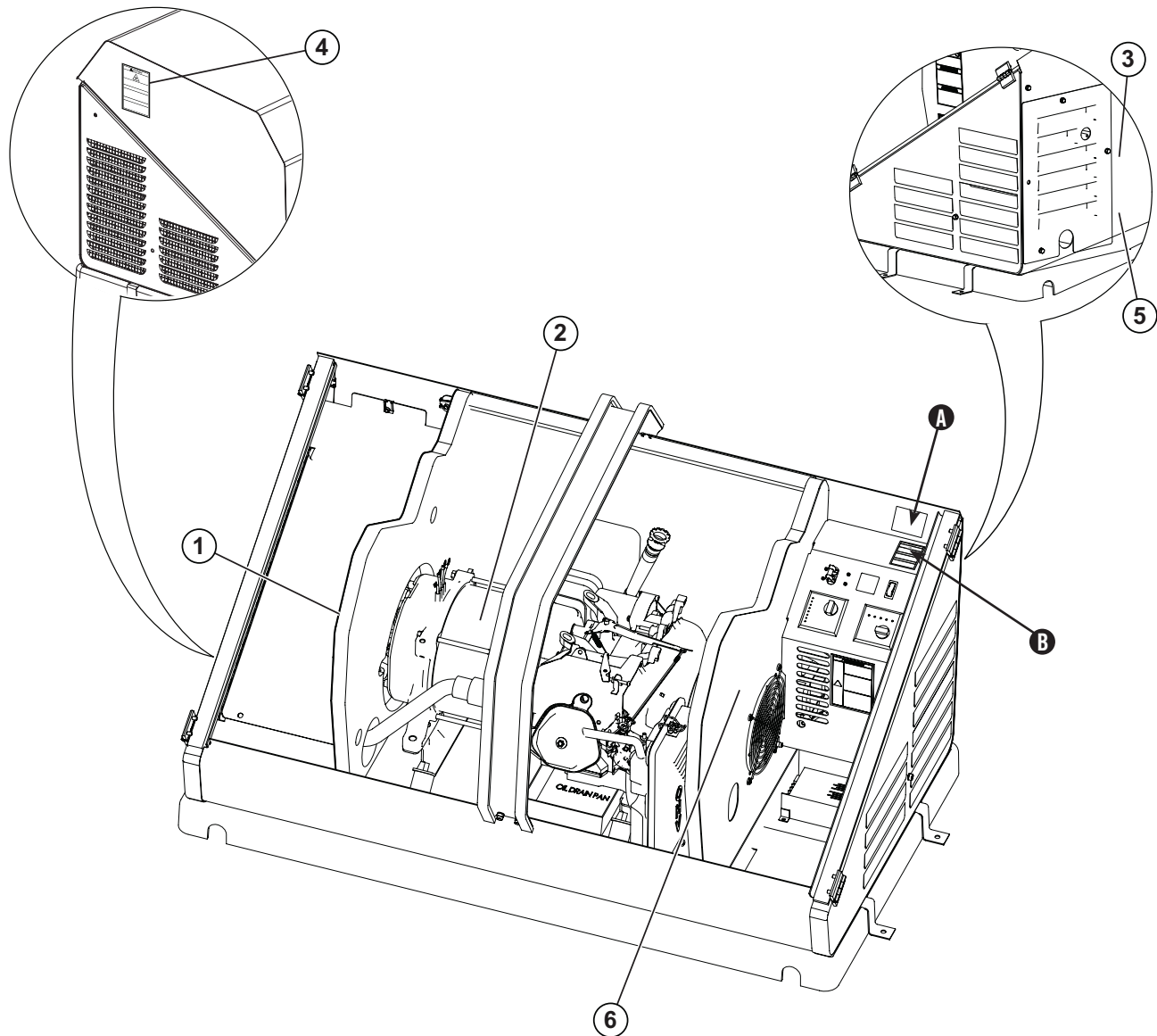

A) Serial number location

B) Nameplate

PLACEMENT & INSTALLATION GUIDELINES FOR CHAMPION 8.5KW HOME STANDBY GENERATOR TO REDUCE THE RISK OF FIRE

/// NATIONAL FIRE PROTECTION ASSOCIATION (NFPA) STANDARD NFPA 37 REQUIREMENTS AND TESTING

REQUIREMENTS:

NFPA 37 2010, section 4.1.4, Engines Located Outdoors.

Engines, and their weatherproof housings if provided, that are installed outdoors shall be located at least 1.5 m (5 ft.) from openings in walls and at least 1.5 m (5 ft.) from structures having combustible walls. A minimum separation shall not be required where either of the following conditions exist:

1. The adjacent wall of the structure has a fire resistance rating of at least 1 hour.
2. The weatherproof enclosure is constructed of noncombustible materials and has been demonstrated that a fire within the enclosure will not ignite combustible materials outside the enclosure.

ANNEX A EXPLANATORY MATERIAL

A.4.1.2 (2) Means of demonstrating compliance are by means of full-scale fire tests or by calculating procedures, such as those given in NFPA 555, Guide on Methods for Evaluating Potential for Room Flashover.

To comply with condition 2 the weatherproof enclosure has been constructed of non-combustible materials and full-scale fire tests have been performed to demonstrate that a fire within the enclosure will not ignite combustible materials outside the enclosure.

Based on this testing and the requirements of NFPA 37, Sec. 4.1.4, the guidelines for installation of the Champion 8.5kW home standby generator are changed to 17.7 inches (45 cm) from the backside of the generator to a combustible wall. All other location and distances remain the same as noted in the Operators and Installation manuals.

These guidelines are based upon fire testing of the generator enclosure and Champion's requirement for air flow for proper operation. Local codes may be different and more restrictive.

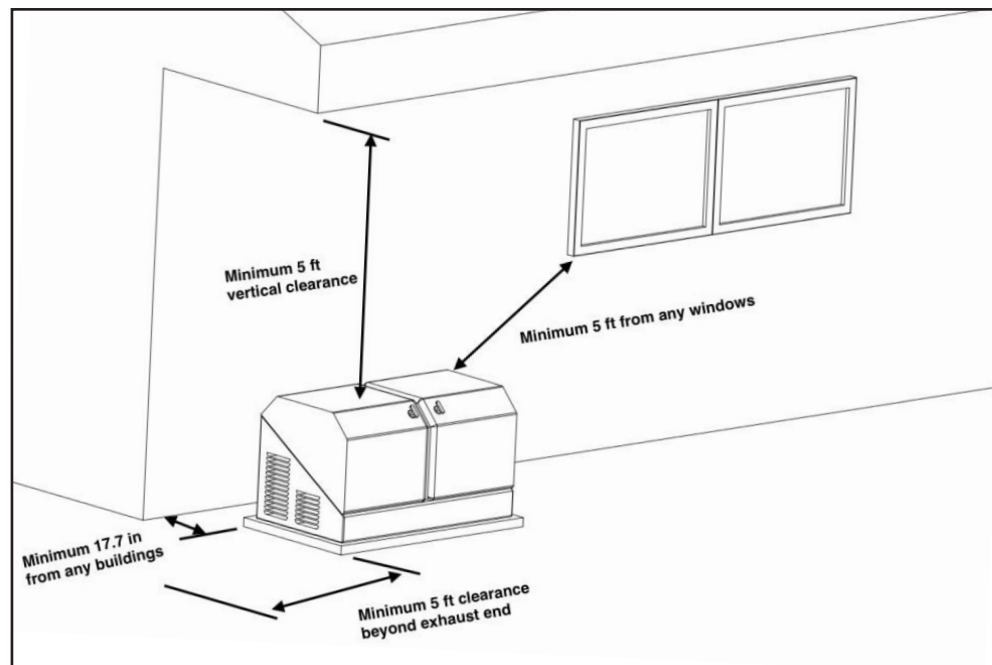

YF POWER TECHNOLOGY CO. LTD. DECAL

LOCATED INSIDE THE GENERATOR, NEXT TO THE GENERATOR'S DATA DECAL

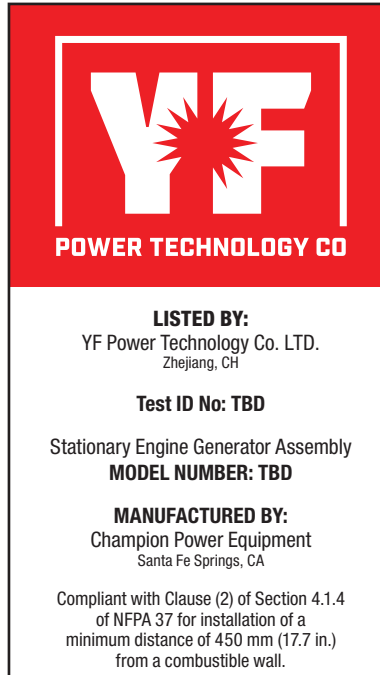

NFPA® 37 STANDARD FOR THE INSTALLATION AND USE OF STATIONARY COMBUSTION ENGINES AND GAS TURBINE

The National Fire Protection Association (NFPA) standard NFPA 37 establishes criteria for minimizing the hazard of fire during the installation and operation of stationary combustion engines. NFPA 37 limits the spacing of an enclosed generator from openings in walls, structures and combustible materials outside the enclosure.

NFPA 37 (2015): Section 4.1.4 stipulates that engines installed outdoors shall be located at least 5 ft. (1.5 m) from structures having combustible walls. Further, a minimum separation shall not be required where the following conditions exist:

1. All walls of the structure that are closer than 5 ft. from the engine enclosure have a fire resistance rating of at least 1 hr., or
2. The weatherproof engine enclosure is constructed of noncombustible materials, and it has been demonstrated that a fire within the enclosure will not ignite combustible materials outside the enclosure.

YF Power Technology Co., Ltd. performed a full-scale fire test under a worst-case fire scenario within the stationary generator enclosure to determine the ignitability of combustible material near the stationary generator. The enclosure is made of non-combustible materials and the results and conclusions of the test indicate that a fire within the enclosure would not pose any risk of ignition to nearby combustible materials or structures. YF Power Technology Co., Ltd. is certifying that this model complies with clause (2) of Section 4.1.4 of NFPA 37 when installed at a minimum distance of 450 mm (17.7 in.) from a combustible wall.

SPECIFICATIONS

Home standby generator	
Maximum continuous power, LPG (Propane)	8.5 kW
Maximum continuous power, NG (Natural Gas)	7.5 kW
Rated voltage	120/240
Amps	70.8/35.4 LPG, 62.5/31.25 NG
Harmonic distortion	Less than 5%
Main line circuit breaker	35.5 amp
Phase	Single
Frequency	60 Hz
Unit weight	365.1 lb. (165.6 kg)
Size (L x W x H)	49.1 x 28 x 28.3 in. (124.7 x 71 x 72 cm)
Engine	
Type	Champion OHV
No. of cylinders	1
Displacement	439cc
Cylinder block	Aluminum with cast-iron sleeve
Ignition system	Solid state – magneto
Spark plug	F7RTC (NGK BPR7ES)
Governor	Mechanical
Starter	Electric 24V DC
Oil capacity	1.2 qt (1.1 L)
RPM	3600
Controls	
Mode switch auto	Auto start on utility failure
Mode switch manual	Starts on demand
Mode switch off	Stops unit/control and charger active
Ready to run/maintenance messages	Standard
Programmable start delay	Standard
Engine start sequence	Standard
Starter lockout	Standard
Battery charger/low battery indicator	Standard
Charger fault	Standard
AVR over voltage protection	Standard
Low oil protection	Standard
Safety fused	Standard
Overcrank/overspeed/underspeed protection	Standard

CHAMPION 439CC ENGINE

The 439cc engine was initially developed by Champion for use in Champion portable generators. The single cylinder, overhead design provides high output, efficient operation, low maintenance and demonstrated long life.

Based on the engine's power, performance and reliability, it was selected to power the 8.5kW Champion Home Stand by generator. This engine design has been used in production since 2008.

The following are the engine specifications:

• Type	Champion OHV (Over head valve)
• No. of Cylinders	1
• Displacement	439cc
• Cylinder Block	Aluminum with cast-iron sleeve
• Cylinder Head	Automotive harden valves and seats
• Ignition System	Solid state – magneto
• Governor	Mechanical
• Starter	Electric 24V DC
• RPM	3,600
• Oil Capacity	1.2 qt. (1.1 L)

CHAMPION 439 CC ENGINE TORQUE SPECIFICATIONS

• Crankcase Cover Bolts	24.4 Nm (216 in.-lbs)
• Connecting Rod Bolts	18 Nm (156 in.-lbs)
• Rocker Cover Screws	5.4 Nm (48 in.-lbs)
• Cylinder Head Bolts	39 Nm (29 ft-lbs) (348 in.lbs)
• Intake Manifold Screws	9.5 Nm (84 in.-lbs)
• Carburetor to Intake Manifold	9.5 Nm (84 in.-lbs)
• Blower Housing	12.2 Nm (108 in.lbs)
• Flywheel Nut	115 Nm (85 ft-lbs)
• Ignition Coil Bolts	9.5 Nm (84 in.-lbs)
• Starter Motor Bolts	24.4 Nm (216 in.-lbs)
• Spark Plug	20 – 30 Nm (14.8 – 22.1 ft-lbs) (178 in.lbs – 265 in.lbs)
• Air Cleaner box to Carb	9 Nm (84 in.-lbs)
• Exhaust pipe nuts	18 Nm (13 ft.-lbs) (156 in.lbs)

MASTER MIXING ASSEMBLY JETS (CARBURETOR SYSTEM)

• Idle/low-speed Jet	1.8-2.5 Nm (15.9-22.1 in. lbs)
• Main Jet	1.2-1.5 Nm (10.6-13.2 in. lbs)

SPECIFICATIONS

ALTERNATOR OVERVIEW

The alternator is made up with the following major components;

1. Brush holder assembly
2. Rear bearing carrier
3. 2 pole rotor (all copper wire)
4. Stator assembly (all copper wire)
5. Engine adaptor

The current flow creates a magnetic field around the rotor having a flux concentration that is proportional to the amount of current flow.

/// ROTOR ASSEMBLY

The alternator has a 2-pole rotor, which means the rotor has a single south magnetic pole and a single north magnetic pole. As the rotor spins, its magnetic field passes through the stator assembly windings and voltage is induced into the stator windings. This is known as induction. The rotor shaft has a negative (-) slip ring and a positive (+) slip ring, with the negative (-) nearest the bearing carrier. The rotor shaft is held in place with single through bolt.

/// STATOR ASSEMBLY

The stator houses, AC power windings and excitation windings. It is held in place with 4 bolts that pass through the bearing carrier and engine adaptor, then attached to the engine mounting flange. In combination with the rotor assembly, they generate the electrical out-put of the HSB.

/// BRUSH HOLDER AND BRUSHES

The brush holder is a component that holds the brushes in a stationary position enabling them to maintain contact with the rotating surface commutator rings on the rotor. The brush holder is attached to the rear bearing carrier by means of a M5 x 20 bolt and a location tab. A negative (-) brush and a positive (+) brush are retained in the brush holder. The negative (-) brush rides on the slip ring nearest the bearing carrier. The brushes are spring loaded to maintain contact.

A RED wire connects to the positive (+) brush and a BLACK wire to the negative (-) brush. Rectified and regulated excitation current, as well as current from the field boost circuit, are delivered to the rotor windings via the RED wire, and the positive (+) brush and slip ring. The excitation and field boost current passes through the windings and to the frame ground via the negative (-) slip ring and brush, and the BLACK wire.

UNPACKING **WARNING**

The HSB weighs more than 300 lbs. (136 kg). Use the aid of additional assistants and exercise caution during installation.

Inspect the generator for damaged or loose parts. DO NOT operate the generator if any components are damaged or loose. Contact your dealer for assistance.

1. Cut banding straps
2. Remove top lid
3. Remove center cardboard supporting rib
4. Lift cardboard housing and set aside with all other trash
5. Remove plastic covering and discard
6. Remove 4 securing clamps. Save if going to use anchor bolts to secure to concrete pad
7. Insert 2 lifting rods (not supplied) into lifting notches at each end of the base
8. Discard all shipping materials and recycle if possible

NOTICE

- If you know length of run for wires you may want to install the ATS communication wires and voltage wires now before setting unit to industry 1st 17.7 in. from fire rated wall and when code permits. Install the wires, some of the gas delivery pipes and flex hose now while you have ample room and at tailgate height is much easier than when in place
- Cardboard can be used for kneeling

INSTALLATION

GENERATOR SIZING

Proper sizing is crucial to ensure that you purchase a model that will supply enough power to your home during a power outage. You need to determine the extent of the devices and appliances you need to power. Remember that when you have lost power (utility) at your home, you probably will not run every device or appliance. Understanding that each device or appliance has an electric consumption value generally referenced to as wattage or kilowatts. There are a number of other factors to include of which these two are important; continuous (running) watts and peak (start-up) watts.

Continuous (running) watts is the amount of watts utilized by the device or appliance while it is running and providing you service.

Peak (start-up) watts is the requirement of the device or appliance to start or kick-in. In others words, the amount of power (watts) needed to start a device or appliance to initially get the motors driving, requires additional power. Like your car, when you accelerate to a specific speed the engine requires more power to move your vehicle, once you have achieved the desired speed your car is now in the running mode and can cruise along at a maintained level at a lower RPM. The system doesn't require as much power for steady performance just getting there.

Most calculators or sizing guides add 20% and provide you with an average usage to cover Continuous (running) and Peak (start-up) wattage. This additional compensation is also for differing wattage ratings among devices or appliances. Most devices or appliances carry tags that reflect wattage usage and you could find each label/tag and add them together to find a starting point to the size of generator you would like to have.

Generators have built in limitations of output power (available wattage or kilowatts). The rating output of the generator is listed as Watts or kW (kilowatts). One thousand (1,000) watts is equal to 1kW (kilowatt). Portable generators are generally smaller in output and are mobile. HSB (home stand by) generators are stationary or permanently mounted. The larger the unit the larger the unit cost and installation costs. Example, most portable generators are rated in WATTS and HSB (home stand by) are rated in kW (kilowatts). 8000 watts is not more than 8kW, it's the same output. The larger the RATING the more output wattage or kW you have available to power your home. The more output equals more devices or appliances you may power.

There is a HSB sizing guide on Champion web, www.championpowerequipment.com.

Before installing the generator, review *SAFETY section starting on page 8*.

Have the generator installed by an authorized CPE dealer. Install the equipment in compliance with the National Electrical Code (NEC) and local codes. This could include electrical and fuel supply permits and certified installers. For Canadian installations, refer to Canadian Electrical Code (CEC).

This generator is designed to be installed outdoors only.

Before installing the generator, obtain a building permit and contact your local utility companies to mark the locations of underground cables and pipes.

SITE SELECTION, PREPARATION AND PLACEMENT

These items are important to the overall performance of the HSB generator. Many items covered in this section are not optional and are requirements under Federal, State and Local codes. As with all generators, your generator must be installed in accordance with current NFPA-37, NFPA 54, NFPA 58 and NFPA-70 standards. Contact your local electrical inspector or city hall to insure you are aware of all codes and regulations. Install the equipment in compliance with the National Electric Code (NEC). For Canada installations, refer to Canadian Electrical Code (CEC). Contact your natural gas supplier to verify that increased BTU gas demand can be handled with the existing NG meter. The same should done for LPG fueled generators. This generator in the enclosure is designed to be installed outdoors only.

Champion HSB units are run and tested at the factory prior to being shipped. They do not require any type of break-in period.

/// SITE SELECTION

The installation of the HSB must comply strictly with NFPA 37, NFPA 54, NFPA 58 and NFPA 70 standards.

Always install your generator within 20 feet of the NG meter, the closer the better. This will reduce expensive costs of running fuel line. In some cases longer runs of fuel line, when not properly sized may cause inadequate fuel delivery. This could result in poor starting, lower outputs and diminished overall performance of the unit. The Champion HSB is shipped from the factory set up for natural gas (NG) fuel. The HSB can be converted to LPG if required. Orifices in the master mixer assembly (carburetor) MUST be changed. The LPG orifices are shipped with the unit and include installation instructions.

Install the unit in a location where the sump pump discharge, rain gutter downspouts, roof run off, landscape irrigation, natural

INSTALLATION

ponding or water sprinklers will not flood the unit or spray the enclosure entering any inlet or outlet opens.

Position the unit in an area where prevailing winds will carry the exhaust gas away from any potentially occupied building or structure.

Install the unit where leaves, grass, snow, ect., will not obstruct air inlet and outlet openings. If prevailing winds cause blowing or drifting, you may consider building a windbreak, planting trees or shrubs within the guidelines and codes applicable.

Watch out for roof overhangs. Snow, ice or rain shouldn't be permitted to accumulate on the roof and then cascade onto the unit.

DANGER



Engine exhaust from the unit is hot and dangerous. Exhaust must be allowed to dissipate into a free air zone as listed in the applicable codes with no obstructions.

Direct the HSB exhaust away from or parallel to the building or structure. DO NOT direct the HSB exhaust toward a potentially occupied building, structure, windows, doors, ventilation intakes, soffit vents, crawl spaces, open garage doors or other openings where exhaust gas could accumulate and enter inside or be drawn into potentially occupied buildings or structures.

Install the unit on higher ground where water levels will not rise and endanger it. This unit shouldn't be operated in standing water.

DO NOT place HSB waterproof enclosure under a deck or other type of structure that may confine or restrict airflow. Operate HSB only outdoors, where adequate ventilation and air movement is available. Avoid installations under decks, inside garages or carports, in basements, along home exterior within 5 feet (1.5m) of home vent, roof overhang vents, a window that can be opened, or other such home invasion points. Use the same precautions when installing HSB at property line, close to a neighbor's home, or any building or structure that houses animals.

DANGER



Running engines give off carbon monoxide, an odorless, colorless, invisible, poison gas. Breathing carbon monoxide will cause fatigue, headache, dizziness, vomiting and in prolonged conditions, even death. Carbon monoxide detectors MUST be installed and maintained indoors according to the manufacturer's instructions/recommendations. Smoke alarms cannot detect carbon monoxide gas.

The back of the HSB locates the fuel and wire entry points. When placement/mounting is done this side generally faces the closest point to each of those sources.

It is always recommended to prepare a drawing showing location of HSB, typical gas utility approach, circuit connections and full load connections.

Similar considerations should be given to the location of the ATS (automatic transfer switch) in relationship to the HSB generator. The closer to both the fuel meter and the main utility panel the better. The key point here is, the closer to fuel meter is the suggested direction to go, wire is cheaper to run and more flexible.

/// PREPARATION

Champion recommends using a mixture of pea gravel and sand or crushed stone for placement of the mounting pad. The mounting pad **MUST** be level. The gravel mixture or crushed stone is to permit water runoff, drainage and reduce ponding of water around the HSB.

Dig an area 5 inches (12.7 cm) deep that is 6 inches (15.2 cm) longer and wider than the foot print of the HSB. The HSB is 49 inches long X 28 inches wide (124.5 cm long X 71 cm wide).

Cover the dugout area with a weed barrier or landscape cloth if desired.

Fill the area with pea gravel and sand mixture or crushed stone. Final stone level must be 2 or 3 inches higher than the original ground level to ensure water run-off and drainage.

INSTALLATION



Compact the fill, this is to provide a firm base for the HSB. Remember the final stone level must be 2 or 3 inches higher than the original ground level to ensure water run-off and drainage.

A concrete pad can be poured and the HSB secured to it. In some areas a concrete pad is required due to high wind potential. Check local codes to see what type of mounting base is required. If a concrete pad is required, all federal, state and local codes should be followed. Unless mandated by federal, state or local code, a concrete pad is not required.

TOOLS REQUIRED

1. General SAE and Metric hand tools, wrenches, sockets and screwdrivers.
2. Standard electrician's hand tools, drill and bits.
3. Monometer (for checking fuel pressures).
4. Meter capable of measuring AC/DC Voltage and Frequency
5. Safety apparel

Inspect the unit. Carefully inspect the HSB for any damage that may have occurred during shipment and delivery. If loss or damage is noted at the time of delivery, have the person(s) making delivery note all damage on the freight bill and affix their signature under the consignor's memo of loss or damage. If loss or damage is noted after delivery, separate the damaged materials and contact the carrier for claims procedures. Parts damaged in shipping are not covered under Champion warranty.

Unbox the unit, by removing the exterior shipping carton. The ATS is included, remove the packaging and lift it out. Remove the 4 shipping brackets, 2 on each end that hold the HSB to the wood shipping pallet. This pallet is for shipping/transportation only and cannot be used as a mounting pad in any form. Exercise caution when removing the HSB from the wood pallet, dragging it off the wood pallet will damage the HSB base. The HSB must be lifted from the wood pallet to separate.

Contact your natural gas (NG) supplier about the meter size. Most meters must be replaced with a larger BTU size, due to a larger demand of BTU's from the HSB and appliances during operation (utility outage). This also applies to HSB utilizing LPG.

/// PLACEMENT

The Site Selection has been completed, all federal, state and local codes have been reviewed and applied as mandated by the NFPA standards and all other related codes/standards.

Preparation has been completed and everything has been properly prepared to place the HSB.

The back side of the HSB locates the fuel and wire entry points. When placement is done this side generally faces the closest point to each of those sources.



⚠ CAUTION

The HSB weighs more than 300 lbs. (136 kg). Proper tools, equipment and qualified personnel should be used in all phases of handling and moving the HSB. Do not lift or move the HSB without assistance. Do not lift the unit by the roof or any other enclosure component as damage to the HSB and possible injury of handling/moving staff may occur.

Two (2) 5 foot (1.5 m) lengths of 3/4 " steel pipe (supplied by the installer), are required to lift the HSB. Insert the steel pipes through the lifting holes located near the HSB base in the composite pad, on each end.

You may also lift the HSB using a properly rated strap, lift, hook and hoist procedure attached to both steel lifting pipes, provided that you use spreader bars to ensure that the belts, chains or cables DO NOT touch/contact the HSB.

INSTALLATION

Once the HSB has been placed, check to make sure it is level. If it isn't, make adjustments prior to installation procedures start.

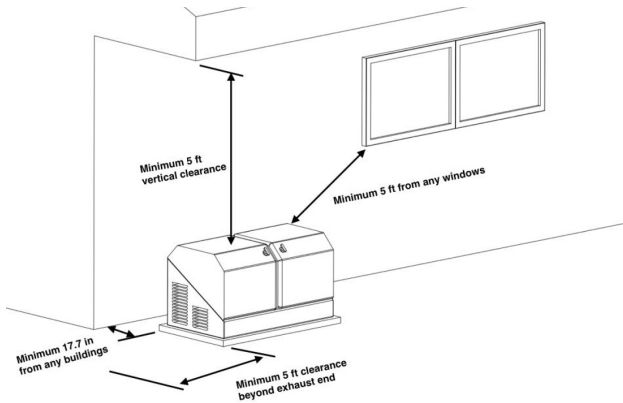

INSTALLATION PREPARATION

WARNING



Improper installation can result in personal injury and damage to the generator. It may also result in the warranty being suspended or voided. All the instructions must be followed including location clearances and pipe size.

Once Site Selection, Preparation and Placement has been completed, you can proceed to Installation Preparation. Without these in place you may encounter problems moving forward.

There are a number of key items that **MUST** be addressed prior to the physical installation of the HSB. The installation of the HSB must comply strictly with all applicable codes, standards and regulations (NFPA 37, NFPA 54, NFPA 58, and NFPA 70).

Check and confirm that the HSB on board controls are "ALL" in the "OFF" position. This includes; Control panel circuit breaker, exercise control and both LED controllers.

Champion HSB units have been run and tested at the factory prior to being shipped. They do not require any type of break-in period.

CAUTION

Never operate the HSB with the engine oil level below the "ADD" mark on the dipstick, doing so could damage the engine. Check the oil level and add the appropriate viscosity and amount indicated on the oil dipstick full line. Oil viscosity 5 w 30 full synthetic. Refer to Owner's manual.

IN THE THIS SEGMENT, "INSTALLATION PREPARATION, THE FOLLOWING WILL BE COVERED;

1. Fuel Requirements and Recommendations
2. Fuel Consumption
3. NG Pipe Sizing, flexible fuel line
4. LPG Vapor Pipe Sizing, flexible fuel line
5. Converting to LPG
6. Full Flow Shut Off Valve
7. Sediment Trap
8. Checking Pressure with a Manometer
9. Battery Requirements, Installation & Service

/// 1. FUEL REQUIREMENTS AND RECOMMENDATIONS

The following NG and LPG fuel information is provided to assist the fuel installer. This information should not be deemed to be all inclusive or to conflict with local dry fuel codes. Consult your local fuel supplier or Fire Marshall for guidance on proper local codes and installations. Local codes will mandate correct routing of gaseous fuel line piping around gardens, shrubs and other landscaping to prevent any damage.

Special considerations should be given when installing the HSB where local conditions include might flooding, tornados, hurricanes, earthquakes and unstable ground. These are considerations for the flexibility and strength of piping and their connections.

NG is lighter than air and will collect in high areas. LPG is heavier than air and will settle in low areas.

INSTALLATION

DANGER

Gaseous fuels such as NG and LPG are highly explosive. Even the slightest spark can ignite such fuels and cause an explosion, which could cause burns, fire or explosion resulting in serious injury, property damage or even death. NO leakage is permitted.

Recommended fuels should have a BTU content of at least 1,000 BTU's per cubic foot for NG, or at least 2,500 Btu's per cubic foot for LPG. Ask the fuel supplier for the Btu content of the fuel.

Before NG fuel lines plans are made, call your NG supplier, provide them information on the amount cubic feet/hour and the BTU's/hour that the HSB will use, and ask if the NG meter and primary regulator can accommodate the addition of the NG generator. NG companies have different meters for increased BTU demands. Utilize the "Fuel Consumption (BTU) Chart" contained in this manual or the Installation Manual for your specific HSB model.

Verify that the current gas meter is capable of providing enough fuel flow to include household appliances and other loads including the addition of the HSB. Check the NG primary regulator, connected at the NG meter output. The correct primary regulator is set at 6 to 8 inches water column. The existing primary regulator may be undersized once the HSB is added.

The HSB engine can run on either NG or LPG. The HSB comes equipped from the factory to run on NG. If your installation requires the engine to run on LPG, orifices in the master mixer assembly (carburetor) MUST be changed. The LPG orifices are shipped with HSB. Refer to "Converting to LPG" in this manual or the "Installation Manual" for your specific HSB model.

Fuel System Requirements	LPG	NG
Fuel supply inlet	3/4 in. NPT	
Fuel supply pressure	10 – 12 inch-H2O. (2.5 – 3.0 kPa W.C.)	5 – 7 inch-H2O (1.2 – 1.7 kPa W.C.)
Maximum flow rate @8.5 kW	146,667 Btu/hr	135,760 Btu/hr

Nominal Fuel Rating	
LPG	2500 Btu/ft ³
NG	1000 Btu/ft ³

Install the fuel system in accordance with NEC and local codes. The HSB is EPA Phase 3 certified for LPG and NG fuels.

/// 2. FUEL CONSUMPTION

Air density is less at high altitudes, resulting in less available engine power. Engine power will decrease 3.5% for each 1,000 feet (300 m) above sea level and 1% for each 10 degrees F above 77 degrees F. Make sure these factors are considered when determining total HSB load.

The gas supply and pipe MUST be sized at 100% load Btu rating. Understand that as a specific fuel supply line pipe diameter is extended in length, its ability to carry the volume of gas diminishes in direct proportion. Improper fuel pipe sizing is the number one reason for poor operating performance (hard starting, output).

Required fuel pressure for NG is 5 – 7 inches water column. Required fuel pressure for LPG vapor is 10 – 12 inches water column. These are estimated fuel supply requirements listed. Refer to "Fuel Consumption Chart" contained in this manual or Installation Manual for your specific HSB model.

Fuel Type	Percent of Load	Btu/hr
LPG	25%	74,121
	50%	100,783
	75%	126,563
	100%	146,667
NG	25%	94,673
	50%	108,369
	75%	122,989
	100%	135,760

/// 3. NG PIPE SIZING

The HSB leaves the factory set up for NG, no changes or alteration need to be made if NG is the fuel source you are going to use. The following NG fuel information is provided to assist the fuel installer. This information should not be deemed to be all inclusive or to conflict with local dry fuel codes. Consult your local fuel supplier or Fire Marshall for guidance on proper local codes and installations. All piping must comply with NFPA 54

INSTALLATION

and related codes. Gas line connections should be made by a certified plumber familiar with local codes.

Always use AGA approved gas pipe and a quality pipe sealant or joint compound. The piping should conform to federal and local codes, rigidly mounted and protected from vibration. Piping should be black iron or steel to avoid reacting with the sulfur in the fuel.

DANGER

NG is highly explosive. Even the slightest spark can ignite and cause an explosion, which could cause burns, fire or explosion resulting in serious injury, property damage or even death. NO leakage is permitted. Safety is important.

Gas pipe sizing is critical to the proper operation of the HSB. The HSB fuel inlet size has no bearing on the proper gas pipe size running to the HSB. Gas supply and pipe **MUST** be sized at 100% load BTU rating. Understand that as a specific fuel supply line pipe diameter is extended in length, its ability to carry the volume of gas is diminished in direct proportion.

Pipe sizes are measured by inside diameter (ID) to include any fittings, valves, elbows, tees or angles. Add 2.5 feet (.76 m) per bend, tee or angle in the pipe line to the overall distance, for each 90 degree elbow, add 8 feet (2.4 m) to the measurement. Use a pipe sealant or joint compound approved for use with LPG/NG on all threaded fittings to assure zero leakage.

A dedicated NG fuel supply line pipe and primary gas regulator is mandatory for proper operation. A minimum of one (1) approved, external manual full flow shutoff gas valve must be installed in the fuel supply line pipe leading to the HSB. This line must be easily accessible.

FLEXIBLE FUEL LINE

A flexible fuel line (enclosed with the HSB) is to be installed between the stationary fuel supply line pipe and the fuel inlet pipe to the HSB. The purpose of the flexible fuel line is to ensure that vibration from the HSB does not cause a gas leak at one of the connection points. The flexible fuel line is not to be installed underground, in contact with any enclosure parts or contact with the ground. The entire flexible fuel line must be visible for periodic inspection and must not be concealed within nor contact nor run through any wall, floor, partition or fence. Never bend flexible fuel line to avoid using an elbow. Bending the flexible fuel line decreases its ability to absorb vibrations and could restrict

the actual fuel flow. Because a HSB engine is prone to vibration, a flexible piping connection to the gas supply is required. Connect the HSB to the gas supply piping with an approved flexible gas line according to local codes. The flexible gas line also protects against settlement between the HSB pad and the ridged gas supply piping.

Check for leaks by spraying all connection points with a soap solution made of dishwashing liquid and water. If you see bubbles, this indicates a leak and the connection should be corrected. Check each connection point, there should not be a visible bubbling when soap solution applied. Installed piping must be properly purged and leak tested, in accordance with applicable codes and standards. A sediment trap should be placed in the fuel supply pipe line to drain any condensation.



Refer to the “Fuel Pipe Sizing Chart” contained in this manual or the Installation manual for your specific HSB model. Champion HSB units have been run and tested at the factory prior to shipment. They do not require any type of break-in period.

FUEL PIPE SIZING CHART

NOTICE

Reduced pipe size will affect fuel delivery and performance.

Measure the pipe length from the generator fuel inlet to the primary gas pressure regulator.

Pipe Length*	NG
25 ft (8 m)	3/4 in. NPT
50 ft (15 m)	1 in. NPT
100 ft (30 m)	1 in. NPT

INSTALLATION

Pipe Length*	NG
150 ft (46 m)	1-1/4 in. NPT
200 ft (61 m)	1-1/4 in. NPT

*Add 2.5 ft (0.76 m) per bend, tee or angle in the pipe line to overall distance, for each 90 degree elbow, add 8 feet (2.4 m) to the overall measurement.

/// 4. LPG VAPOR PIPE SIZING

The HSB leaves the factory set up for NG. If you are going to fuel the HSB with LPG you MUST change the Master Mixer Assembly (carburetor system) for LPG usage. The HSB will not perform on LPG if the carburetor system is not changed from NG to LPG. Refer to “Converting to LPG” in this manual or the Installation Manual of your specific HSB model. If your installation requires the engine to run on LPG, a set of orifices in the Master Mixer Assembly (carburetor system) MUST be changed. The LPG set of orifices are enclosed (shipped) with the HSB.

The following LPG information is provided to assist the fuel installer. This information should not be deemed to be all inclusive or to conflict with local dry fuel codes. Consult your local fuel supplier or Fire Marshall for final answers on proper local codes and installation. All piping must comply with NFPA 54 and related codes. Gas line connections should be made by a certified plumber familiar with local codes.

DANGER

LPG is highly explosive. Even the slightest spark can ignite and cause an explosion, which could cause burns or fire resulting in serious injury, property damage or even death. No leakage is permitted. Safety is important.

Gas pipe sizing is critical to the proper operation of the HSB. The HSB fuel inlet size has no bearing on the proper gas pipe size running to the HSB. Gas supply and pipe MUST be sized at 100% load Btu rating.

Pipe sizes are measured by inside diameter (ID) to include any fittings, valves, elbows, tees or angles. Add 2.5 feet (.76 m) per any bend, tee or angle in the pipe to the overall distance. For each 90 degree elbow, add 8 ft. (2.4m) to the measurement. Use a pipe sealant or joint compound for use with LPG/NG on all threaded fitting to assure zero leakage.

The LPG must be a vapor withdrawal system. The HSB will not work on a liquid withdrawal system. Gas line connections should be made by a certified plumber familiar with local codes.

New LPG tanks and existing LPG tanks already located at the installation site, have a primary fuel regulator set and intended for home heating and cooking. This regulator might not be properly sized to accommodate the addition of the HSB. Contact the local LPG supplier to properly size the fuel regulator. Make sure the tank is sized large enough to provide the required Btu's for the HSB and all connected appliances.

The LPG fuel tank must have a dedicated primary fuel regulator mounted at the tank fuel outlet point and set for 6 ounce pressure, 10 -12 inch water column. A direct, dedicated fuel line connected directly to the HSB mounted secondary regulator, also set at 6 ounce pressure, 10 -12 inch water column. When sizing the secondary regulator for LP applications be sure to note the maximum individual load capabilities. This could impact HSB starting performance if sized to small. It is not recommended to reduce the fuel supply line pipe exiting the secondary regulator unless to accommodate the flexible fuel line required to install and shipped with the unit. The may result in starting or performance issues with the HSB.

Make sure fuel supply line pipe includes an on/off external manual full flow shut off gas valve at both the LPG tank and at the point of connection to the HSB.

A sediment trap should be installed into the fuel supply pipe line to drain any condensation.

FLEXIBLE FUEL LINE

A flexible fuel line (enclosed with the HSB) is to be installed between the stationary fuel supply line pipe and the fuel inlet pipe to the HSB. The purpose of the flexible line is to ensure that vibration from the HSB does not cause a gas leak at one of the connection points. The flexible fuel line is not to be installed underground, in contact with any enclosure parts or contact with the ground. The entire fuel line must be visible for periodic inspection and must not be concealed within not contact nor run through any wall, floor, partition or fence. Never bend a flexible fuel line to avoid using an elbow. Bending the flexible fuel line decreases its ability to absorb vibrations and could constrict the actual fuel flow. Because the HSB engine is prone to vibration, a flexible piping connection to the gas supply is required. Connect the HSB to the gas supply piping with an approved flexible gas line according to local codes. The flexible gas line also protects against settlement between the HSB pad and the ridged gas supply piping.

INSTALLATION

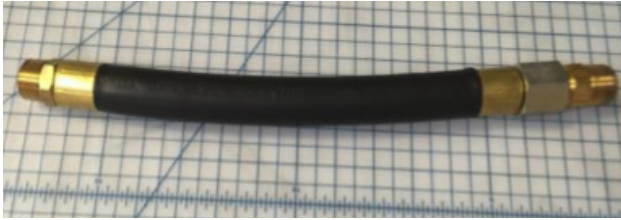

⚠ CAUTION

Check for leaks by spraying all connection points with a soap solution made of dishwashing soap and water. If you see soap bubbles, this would be an indication of a leak and it should be corrected. Check each connection point, there should not be a visible bubbling with the soap solution applied. Refer to the “Fuel Pipe Sizing Chart” contained in this manual or the Installation Manual for your specific HSB model. Installed piping must be properly purged and leak tested, in accordance with applicable codes and standards.

Champion HSB units have been run and tested at the factory prior to shipment. They do not require any type of break-in period.

FUEL PIPE SIZING CHART

NOTICE

Reduced pipe size will affect fuel delivery and performance.

Measure the pipe length from the generator fuel inlet to the primary gas pressure regulator.

Pipe Length*	LPG
25 ft (8 m)	3/4 in. NPT
50 ft (15 m)	3/4 in. NPT
100 ft (30 m)	1 in. NPT
150 ft (46 m)	1 in. NPT
200 ft (61 m)	1 in. NPT

*Add 2.5 ft (0.76 m) per bend, tee or angle in the pipe line to overall distance, for each 90 degree elbow, add 8 feet (2.4 m) to the overall measurement.

/// 5. CONVERTING TO LPG

The engine is fitted with a dual Master Mixer Assembly (carburetor system), which allows the HSB to run on either NG or

LPG. It has been configured at the factory to run on NG. If your installation requires to run on LPG, an orifice in the Master Mixer Assembly (carburetor system) must be changed. The LPG orifices are shipped with the HSB.

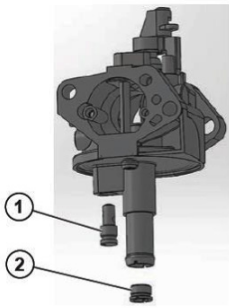

1. Loosen the clamp, disconnect the fuel delivery hose from the bottom of the mixing valve.
2. Use a flat-head screwdriver to remove the idle/low speed orifice (jet) counter clockwise and main orifice (jet) from the mixing valve counter clockwise.
3. Install the LPG orifices (jets) in the mixing valve clockwise. Tighten the low speed orifice (jet) to 15.9 – 22.1 lb.-in. (1.8 – 2.5 N m). The main orifice (jet) to 10.6 – 13.2 lb.-in. (1.2 – 1.5 Nm).
4. Re-install the fuel delivery hose and tighten the clap securely. Check the connection for fuel leaks after installing fuel supply.
5. LPG jet markings on face of jet; LPG main jet L41, LPG idle jet LO



1. LOW SPEED JET
2. MAIN JET

/// 6. FULL FUEL SHUT OFF

A minimum of one accessible, approved manual full fuel shutoff valve shall be installed in the fuel supply line of the HSB. A manual full fuel shut off valve should be installed inside the building, for those locations with inside gas meters. The full

INSTALLATION

flow shut off valve should be installed in accordance with all applicable codes and standards.



/// 7. SEDIMENT TRAP

A sediment trap should be installed into the fuel supply line pipe when using either NG or LPG to drain any condensation. Always make sure the HSB is completely in the OFF position and the full flow fuel shut off valve is closed before removing the sediment trap for drainage. Use a pipe sealant or joint compound approved for use with LPG/NG on all threaded fittings to reduce the possibility of leakage. Install a sediment trap downstream of the HSB shut-off valve as close to the inlet as possible in accordance with local codes.



/// 8. CHECKING PRESSURE WITH A MANOMETER

This check should only be done when the HSB and ATS have been installed, properly inspected and ready for testing.

A Manometer is a general term for any device that measures pressure. A gas Manometer measures gas pressure. It's important to make sure the correct amount of fuel is being delivered to the HSB when it starts and at full load usage, the Manometer provides the ability to check the fuel pressure throughout the operation of the HSB. A Manometer port should be placed in the fuel supply pipe line.



CAUTION

Remove the plug, install the Manometer. Open the gas supply valve check to make sure the pressures are within the specified values for NG or LPG. This is always a good starting point for evaluations related to poor performance.

After all appliances have been turn on, start the HSB. If the Manometer stays within 5 -7 inches of water column for NG, 10 -12 inches of water column for LP, with full load applied to a proper running HSB, the installation is good.

If the Manometer reading falls below the listed inches of water column for either specific gas rating while the HSB engine is starting or running. It may be an indication that the gas meter or primary regulator is undersized.

If the Manometer reading stays within the specific gas rated inches water column, but the HSB engine will not start, run erratic, it may indicate insufficient fuel volume due to long fuel supply pipe line, incorrect full pipe diameter. Recheck you initial calculations to ensure where the problem might exist. Champion HSB units have been run and tested at the factory. They do not require any type of break-in period.

/// 9. BATTERY REQUIREMENTS, INSTALLATION & SERVICE

Battery sizing is a topic that is discussed and debated for a number of reasons. The battery size, cold cranking amps (CCA), starting cycle or deep cycle are all items for consideration. The following will assist you to better understand the battery, the codes and the purpose of the battery. It is extremely important

INSTALLATION

to follow all cautions and warnings per the battery manufacturer concerning installation, service, maintenance and replacement procedures.

Battery Council International (BCI) is an association of battery industry companies whose members establish policy and standards for the industry.

Battery Size is the physical dimensions of a battery. BCI assigns letters and numbers for North American battery size types.

Cold cranking amps (CCA) is a rating that is used to define the batteries ability to start an engine under low-temperature conditions. BCI defines it as “the number of amps a lead-acid battery at 0 degrees F can deliver for 30 seconds”.

Starting (cranking) cycle battery is designed to deliver large bursts of power for a short time, as needed to start an engine. Starting batteries are intended to have a low depth of discharge on each use.

Deep cycle battery is designed to continuously provide power for long periods of time (for example in a trolling motor, auxiliary power for a RV or traction power for a golf cart or other battery electric vehicle).

Two (2) 12 volt Group U1 batteries with a minimum of 350 CCA each. Battery size: 7 ^{3/4} L x 5 ^{3/16} W x 7 ^{5/16} H inches (196mm L x 131mm W x 185mm H). This is based on testing in extreme cold and heat -22° F (-30° C) to 104 ° F (40° C). Purchase batteries locally. Install positive cable first.

This is a 24 volt system. Most large trucks, buses and even some RV's use 24 Volt systems. While it is true that two batteries, whether parallel (12 Volts), or in series (24 Volts) wired will produce the same power, our 24 volt system makes it easier to transfer power through higher voltages. With 24 Volts the engine starter turns almost twice as fast as a 12 volt. This increased starting speed enhances fuel delivery and combustion chamber ignition in all weather conditions, especially in cold climate areas.

All 12 VDC batteries will lose a certain percentage of their charge while in storage. It is important to test the battery voltage before it is installed in the generator and taken to the job site. A fully charged battery must test at 12.5 – 13.0 volts DC at 70 degrees F. Also the correct batteries must have lug terminals to match lug battery cables, for a bolt-together connection. All cautions must be taken in accordance with the battery manufacturers recommendations.

Check and confirm that the HSB on board controls are “ALL” in the “OFF” position. This includes; circuit panel breaker, exercise control and both LED controllers. Turn off utility power supply to the ATS (automatic transfer switch), place ATS in “OFF” mode.

WARNING



The starting system is a 24-volt DC system. The two 12-volt batteries **MUST** be wired in series to achieve the correct voltage. Damage will result if the battery connections are made in reverse, refer to owner manual or installation manual for typical installation. Dielectric grease should be applied on battery posts to aid in prevention of corrosion. Cables supplied with the HSB.

1. Place the batteries into the built in battery tray.
2. Connect one of the black cables (included) from negative (-) terminal of battery 1 to the positive (+) terminal of battery 2.
3. Connect the red cable (included) from the positive (+) terminal of battery 1 to the engine starter.
4. Connect the black cable (included) from negative (-) terminal of battery 2 to the engine ground.
5. Install red battery post covers.
6. Dielectric grease should be applied on the battery posts to aid in the prevention of corrosion.
7. Inspect, clean or re-grease battery connections every one to two months.

This HSB is equipped with an automatic float type battery trickle charger powered by utility power, to maintain full battery power while in standby (non-running) mode. This trickle charger will not recharge a fully discharged or defective battery. When the HSB is running (during use), the engine provides power to the battery charger, charging the batteries to maintain full battery power.

When doing any work on the batteries always make sure the HSB, ATS and transfer switch from utility are in the “OFF” position or sparking may occur at the battery posts as the cables are attached and cause an explosion.

INSTALLATION

DANGER



Servicing of Batteries are to be performed or supervised by personnel knowledgeable of batteries and the required precautions. Keep unauthorized personnel away from batteries.

- a. Always follow the battery manufacturer's directions.
- b. When replacing batteries, use the same number and the following type batteries: Two (2) 12 volt Group U1 batteries with a minimum of 350 CCA each (cold cranking amps).

CAUTION

A battery presents a risk of electrical shock and high short circuit current. The following precautions are to be observed when working on batteries:

1. Remove watches, rings, or other metal objects,
2. Use tools with insulated handles,
3. Wear rubber gloves and boots,
4. Do not lay tools or metal parts on top of the battery
5. Disconnect charging source prior to connecting or disconnecting battery terminals,
6. Determine the battery is inadvertently grounded. When inadvertently grounded, remove source of ground. Contact with any part of a grounded battery is capable of resulting in electrical shock. The risk of such a shock is reduced when such grounds are removed during installation and maintenance (applicable to a generator not having a grounded supply circuit).

CAUTION

Do not dispose of battery or batteries in a fire. The battery is capable of exploding.

CAUTION

Do not open or mutilate the battery or batteries. Released electrolyte has been known to be harmful to the skin and eyes and can be toxic.

VENTED BATTERIES

The installation of the engine generator shall provide enough ventilation to ensure that all gases generated by vented batteries during charging, or caused by equipment malfunction are removed.

CAUTION

The electrolyte is a diluted sulfuric acid that is harmful to the skin and eyes. It is electrically conductive and corrosive. The following procedures are to be observed:

1. Wear full eye protection and protective clothing,
2. Where electrolyte contacts the skin, wash it immediately with water,
3. Where electrolyte contacts the eyes, flush thoroughly and immediately with water and seek medical attention, and 40 Spilled electrolyte is to be washed down with an acid neutralizing agent. A common practice is to use a solution of one pound (500 grams) bicarbonate of soda to one gallon (4 liters) of water. The bicarbonate of soda is to be added until the evidence of reaction (foaming) has ceased. The resulting liquid is to be flushed with water and the area dried.

CAUTION

Lead-acid batteries present a risk of fire because they generate hydrogen gas. The following procedures are to be followed:

1. DO NOT SMOKE when near batteries,
2. DO NOT cause flame or spark in battery area, and
3. Discharge static electricity from body before touching batteries by first touching a grounded metal surface.

INSTALLATION

FLEXIBLE FUEL LINE

A flexible fuel line (enclosed with the HSB) is to be installed between the stationary fuel supply line pipe and the fuel inlet pipe to the HSB. The purpose of the flexible line is to ensure that vibration from the HSB does not cause a gas leak at one of the connection points.

The flexible fuel line is not to be installed underground, in contact with any enclosure parts or contact with the ground. The entire fuel line must be visible for periodic inspection and must not be concealed within not contact nor run through any wall, floor, partition or fence.

Never bend a flexible fuel line to avoid using an elbow. Bending the flexible fuel line decreases its ability to absorb vibrations and could constrict the actual fuel flow. Because the HSB engine is prone to vibration, a flexible piping connection to the gas supply is required. Connect the HSB to the gas supply piping with an approved flexible gas line according to local codes. The flexible gas line also protects against settlement between the HSB pad and the ridged gas supply piping.



⚠ CAUTION

Check for leaks by spraying all connection points with a soap solution made of dishwashing soap and water. If you see soap bubbles, this would be an indication of a leak and it should be corrected. Check each connection point, there should not be a visible bubbling with the soap solution applied. Refer to the “Fuel Pipe Sizing Chart” contained in this manual or the Installation Manual for your specific HSB model. Installed piping must be properly purged and leak tested, in accordance with applicable codes and standards.

Champion HSB units have been run and tested at the factory prior to shipment. They do not require any type of break-in period.

WIRE SIZING

All installations must comply with National, State and Local codes. It is the responsibility of the installer to perform an installation that will pass the final electrical inspection. Conductor wire sizes must be adequate to handle the maximum current to which they will be subjected. The installation must comply fully with all applicable codes, standards and regulations.

All power cables must enter the enclosure through the knockouts provided. If not using knockouts, conduit entry into the enclosure must be at or below knockouts to maintain the Type 3R rating. NEMA 3R enclosures are rated and tested for outside installation, they are water proof enclosures and only come with knockouts on the bottom side of the enclosure. If a NEMA 3R enclosure is used for an inside installation, a greenlee type punch will be required to make a knockout(s) on the side or top of the enclosure. Conduits should be arranged to provide separation between the Utility Source and HSB Source supply conduits inside the enclosure.

Conductor wires must be properly supported, of approved insulated qualities, protected by approved conduit and of the correct wire gauge size in accordance with all applicable codes.

Before connecting wiring cable to terminals, remove any surface oxides from the cable ends with a wire brush. These oxides can work as insulators, preventing proper flow of current and signals.

⚠ CAUTION

Use a torque wrench to tighten conductors, being sure not to overtighten, or damage to the switch base could occur. If not tightened properly, a loose connection would result, causing excess heat which could damage the switch base.

TRANSFER SWITCH COMMUNICATION WIRE

Maximum wire length	Recommended wire size
1 – 115 ft. (1 – 35m)	No. 18 AWG
116 – 185 ft. (36 – 56m)	No. 16 AWG
186 – 295 ft. (57 – 89m)	No. 14 AWG
296 – 460 ft. (90 – 140m)	No. 12 AWG

Utility Circuit and Generator Power Connections

Conductor sizes must be adequate to handle the maximum current to which they will be subjected to, based on the 75 degrees C column of tables, charts, ect. used to size conductors. The installation must comply fully with all applicable codes standards and regulations.

INSTALLATION

IDENTIFY/SELECT STANDBY CIRCUITS

IDENTIFY THE BASIC NEEDS

It is very important to understand what items the home owner wants powered by the HSB during a utility failure. The selection of these items will indicate which circuits will be selected for connection to the ATS so that they are powered by the HSB. Unforeseen power outages can last from minutes to days, so it is important to focus circuit selections on those that power household items that are deemed essential and within the output capability of the HSB

An authorized or certified dealer or electrician can come to your home and measure the loads with a clamp-on AMP meter which would provide accurate load demands for each circuit tested.

Once you have identified the customer needs, you can properly size the HSB by referring to the sizing guide provided by Champion, www.championpowerequipment.com or call Champion 1-877-338-0999.

Circuits must be protected by the same size breaker. For example, a 15 amp 120 volt circuit in the ATS will replace a 15 amp 120 volt circuit in the main utility distribution panel. When tied together or backed up, the breakers must be the same size.

SURGE PROTECTION

CAUTION

Voltage fluctuation may impair the proper functioning of sensitive electronic equipment.

Electronic devices, including computers and many programmable appliances use components that are designed to operate within a narrow voltage range and may be affected by momentary voltage fluctuations. While there is no way to prevent voltage fluctuations, you can take steps to protect sensitive electronic equipment.

1. Install UL1449, CSA-listed, plug-in surge suppressors on the outlets feeding your sensitive equipment. Surge suppressors come in single or multi-outlet styles. They're designed to protect against virtually all short-duration voltage fluctuations

HOURLY METER & OVER VOLTAGE PROTECTION

/// HOURLY METER

The hour meter keeps track of all running time of the HSB. This includes run time during a utility power outage and during the weekly exercise cycle. This provides the owner with a record of operating time which is useful in keeping track of scheduled maintenance intervals. Refer to the scheduled maintenance chart in your Owner's Manual for specific maintenance.

The hour meter can't be reset. The initial time registered on the meter when first started up (installed) will reflect the factory test time, this is a normal industry standard. The hour meter only reflects hours, it does not reflect RPMs or any other function.

There are 2 pin connectors, both have positive locking connections for correct orientation. Refer to wiring diagram in the owner's or installation manual of your specific model.

1 has a 3 point connector, top is B = Black wire (Gen-AC, L1), center is not used, bottom connector is R = Red wire (L2).

The other is a 2 point connector, top is W = White (B+ on Engine Relay Module), bottom is G = Green (B- on Engine Relay Module).

/// OVER VOLTAGE PROTECTION (OVP)

The OVP is a relay that protects the controls of the HSB from an over voltage situation. By monitoring the voltage output from the generator within pre-determined, factory set parameters, the OVP can close off the path of voltage, should the voltage exceed the limit. Should this occur the HSB system is protected from a potential overload situation, turns off and shuts down the HSB.

There are 2 pin connectors, both have positive locking connections for correct orientation. Refer to wiring diagram in the owner's or installation manual of your specific unit.

The square 4 pin connector, top left position, G = Green wire (Ground), bottom right L/B = Blue/Black (Ignition coil), top right is not used.

The rectangle 3 pin connector, top position, R = RED wire (L2), middle is not used, bottom is W = WHITE (Neutral).

SET EXERCISE TIME

To set the exercise time,

1. The Engine Control Module switch must be in the ATS mode.
2. Decide on the desired day and time to exercise the HSB generator.
3. Press the exercise switch to ON.
4. The HSB generator will start and run for 15 minutes and then shut off.
5. The exercise time is now set.
6. The HSB generator will begin the next exercise period exactly 168 hours from when the exercise switch was pressed to the ON position. The exercise switch incorporates a built-in timer.
7. Load transfer from the HSB generator output will not occur unless the utility power is lost.

The exercise time setting is specific to the day and time you set it on site.

When the exerciser switch is in the OFF position, the exercise function is disabled.

Reset or change exercise time

If you chose to change the current exercise time setting or reset the time setting, choose the new day and time. Switch the exercise switch to OFF and then to ON and it will begin the cycle again.

EXERCISE TIME WILL HAVE TO BE RESET IF;

1. The battery was disconnected from the HSB generator.
2. The exercise switch was moved to the OFF position for maintenance.

AVR = AUTOMATIC VOLTAGE REGULATOR

The AVR is an electrical or electronic device that maintains the voltage of a power source within predetermined limits. AVR is a regulator that automatically keeps voltage within the prescribed range required by the electrical equipment that will be provided power by the HSB. The AVR uses solid-state semiconductor devices to smooth out variations in the flow of current

The AVR monitors the output voltage and controls the input voltage to the exciter of the generator. By increasing or decreasing the generator control voltage, the output voltage

of the generator increases or decreases accordingly. The AVR calculates how much voltage has to be sent to exciter numerous times a second, therefore stabilizing the output voltage to a predetermined set point.

There are 3 connectors that come from the AVR. For reference we have numbered them 1, 2 and 3 when viewed right to left.

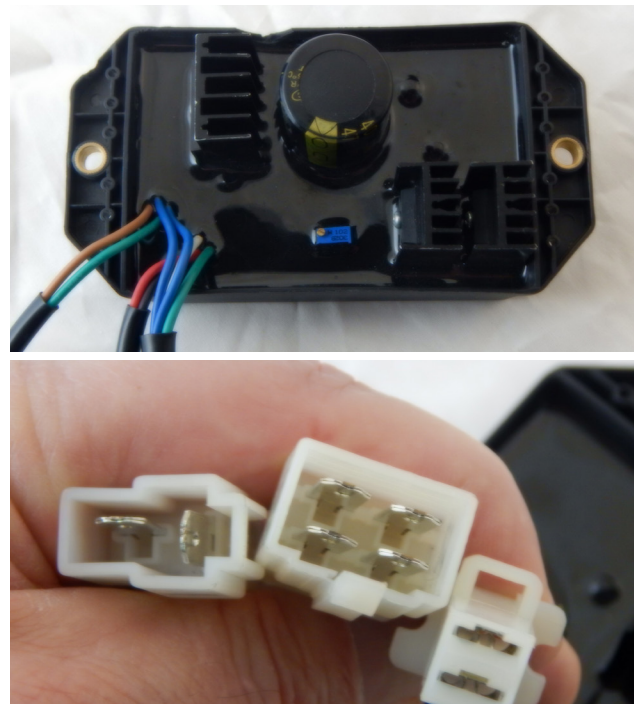

CONNECTOR #1 (far left connector), has 2 leads. A RED lead (top) that runs to the positive side of the brush assembly, and a BLACK lead (bottom) that runs to the negative side of the brush assembly. The brush assembly provides flow through of excitation current to the rotating rotor. Brushes are made of long lasting material that seldom wear out or fail. The contact points of the brush assembly are with two slip rings attached to the rotor. These slip rings can become tarnished or exhibit a glaze, which can create a resistance to the flow of electricity. This can occur when the HSB is not exercised or ran over long periods of storage.

CONNECTOR #2 (center), has 4 leads. The 2 leads on the right side of the connector (top & bottom) are BLUE. They run to the excitation windings on the stator. The 2 leads on the left side of the connector (top & bottom) are GREEN (top) and WHITE (bottom), they run to the sampling windings of the stator.

CONNECTOR #3 (far right), has 2 leads. The top lead is BROWN, when connected it runs to pre-boost/magnetized pin #7 on the Engine Controller Module. The bottom lead is GREEN and runs to ground.

INSTALLATION

SLOTTED POTENTIOMETER is factory set to the correct voltage and should not require adjustment.

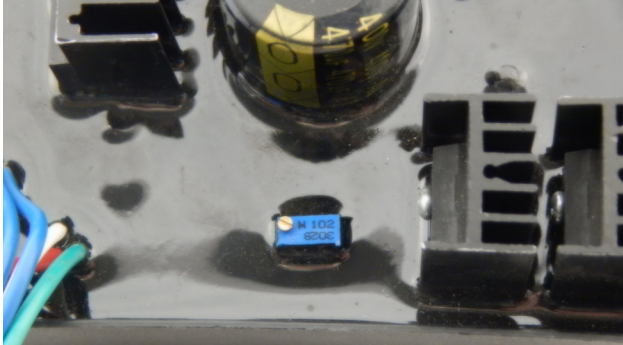

ENGINE RELAY MODULE

This module is the interface between the Engine Controller, ATS Controller, alternator, hour meter and battery charger. It is the interface for all on board communications in the HSB.

The module has two (2) fuses built into the board. On the left side of the module there is a 250VAC 5A mini fuse protecting the system from an over voltage between the alternator and the relays.

The second fuse, is an automotive style fuse, 40A (Orange), which protects the system from an excessive transfer voltage output when the ATS relays transfer between Utility to Genset and Genset to Utility modes.

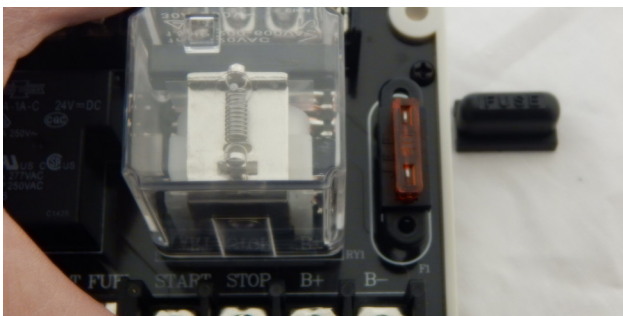

/// TOP ROW

There are 12 wire land points in the top row, the connection points are all the same size. The following are the wire land points, function and wire color, this is viewed left to right.

- | | | | |
|-----|--------------|-------------------------|--------------------|
| 1. | Position #1 | Frequency | R (RED) |
| 2. | Position #2 | Frequency | B (BLACK) |
| 3. | Position #3 | ATS | O (ORANGE) |
| 4. | Position #4 | Exercise | O/B (ORANGE/BLACK) |
| 5. | Position #5 | High Engine Temp | Br (BROWN) |
| 6. | Position #6 | Low oil level/ pressure | Y (YELLOW) |
| 7. | Position #7 | NOT CONNECTED EMPTY | |
| 8. | Position #8 | Fuel supply valve | G/B (GREEN/BLACK) |
| 9. | Position #9 | Starter | B/W (BLACK/WHITE) |
| 10. | Position #10 | Stop | L/B (BLUE/BLACK) |
| 11. | Position #11 | B+ | W (WHITE) |
| 12. | Position #12 | B- | G (GREEN) |

/// BOTTOM ROW

There are 12 wire land points in the bottom row, 8 are the same size, the remaining 4 points are larger, viewed left to right. The following are the wire land points, function and wire color, this is viewed left to right.

- | | | | |
|----|-------------|-----------|--------------------|
| 1. | Position #1 | Frequency | R (RED) |
| 2. | Position #2 | Frequency | B (BLACK) |
| 3. | Position #3 | ATS | O (ORANGE) |
| 4. | Position #4 | Exercise | O/B (ORANGE/BLACK) |

INSTALLATION

5. Position #5	High Engine Temp	Br (BROWN)
6. Position #6	Low oil level/pressure	Y (YELLOW)
7. Position #7	NOT CONNECTED EMPTY	
8. Position #8	Fuel supply valve	G/B (GREEN/BLACK)
9. Position #9	Starter	B/W (BLACK/WHITE)
10. Position #10	Stop	L/B (BLUE/BLACK)
11. Position #11	B+	W (WHITE)
12. Position #12	B-	G (GREEN)

ENGINE CONTROLLER

The Engine Controller Module is equipped to provide monitoring and protection for the HSB. It applies a knob mode switch and provides 3 operation modes; ATS (automatic), OFF and MANUAL. Fault protection includes; over/under speed, high oil temperature, low oil pressure, and over crank. It also displays low battery voltage warning and indicates running and power status. The output functions are executed by a set of traditional relays which make it possible to support the HSB throughout standby mode and operation.

/// MODE SWITCH



ATS POSITION – In this position the system is ready for full automatic operation.

1. Monitors constant utility power source voltage, if the voltage is lost or is not consistent it will automatically start and transfer to HSB.
2. When utility power is lost the Engine Control Module will automatically disconnect the utility power from the home.
3. Command the HSB to start—allowing time for engine warm-up and to bring generator up to maximum capacity.
4. Transfer load to HSB.
5. In this position the HSB will also perform its weekly exercise cycle at the predetermined set time.
6. The HSB will attempt up to 5 starting sequences to successfully start the HSB. If the HSB fails to start after the 5th attempt the RED LED light, “Over Crank” will be lit. The exterior fault code indicator LED on the backside of the HSB will be activated and lit. Should this LED be lit, the unit will not attempt to start or re-start. Follow reset procedures contained in the manuals specific to your model to clear or correct.
7. When the HSB is installed with an Automatic Transfer Switch (ATS), and the ATS and Engine Control Module are in the AUTO positions, the engine can crank and start at any time. To prevent an automatic start of the HSB, both the ATS Control Module and the Engine Control Module must be placed in the OFF positions when all maintenance or service are being performed on or around the unit.

OFF POSITION – This position closes and shuts down the engine signals. It prevents the automatic operation of the generator. This position is required when all maintenance or service are being performed on or around the unit.

MANUAL POSITION – This position allows manual starting of the engine. Load transfer from the HSB output does NOT occur unless the utility power voltage is lost. NOTE: You cannot perform a load test of the generator in the manual position.

EXERCISE LED

The GREEN LED will be lit when the HSB is performing the weekly exercise period. Refer to “Setting Exercise Time” to establish the weekly exercise period. When the exercise period is complete (15 minutes) the LED will turn off and the HSB will resume its standby monitoring. This GREEN LED is only lit during exercise.

LOW BATTERY LED

The YELLOW LED will be lit if the battery voltage fell below 21.0 volts for at least one minute while the engine was running. If

INSTALLATION

the battery voltage rises above 21.1 volts, the LED will turn off. Battery voltage is NOT monitored when the engine is cranking, just when the engine is running. If the YELLOW LED comes on it will not shut the HSB off, it will remain lit until the battery condition meets the required output.

When the LED remains lit, the battery charging should be checked and the condition of the batteries. Follow reset procedures contained in the manuals specific to your model to clear or correct.

HIGH ENGINE TEMP. LED

The RED LED will be lit if the engine operating temperature exceeds the factory preset limits. If excessive operating temperature is detected, the HSB will shut down and re-start will be disabled. The RED LEDs on the module and enclosure exterior are lit.

This failure could be the result of an excessive load or high ambient temperatures. Should this fault occur do the following;

1. Open the enclosure doors to increase air flow throughout the unit.
2. Check oil level, add oil if required.
3. Inspect the interior and exterior of the enclosure for debris, leaves, ect., and remove them to increase air flow around and inside the unit.
4. Once the engine temperature falls into the normal operating range, generally 30 minutes, follow the reset procedures in the manuals specific to your model to clear and correct fault.
5. Close the enclosure doors and the unit is ready to run.

HZ OVER/UNDER SPEED LED

The RED LED will be lit if the engine was operating above or below its preset speed limits. These limits are factory set to protect the HSB and the circuits connected to the generator output circuits. When this fault occurs, the HSB will shut down, light the RED LED, shut down and re-start will be disabled. The exterior fault code LED on the back of the HSB enclosure will be activated and lit.

Appliances connected to the generator circuit could be damaged from high generator output if the engine is allowed to operate above the factory preset limits. If this failure occurs contact Champion or your Authorized Champion Dealer. The RED LED will remain lit until the failure has been corrected, the HSB will not attempt to transfer or run.

LOW OIL LED

The RED LED will be lit when the engine oil level drops below the safe operating level. When this fault is detected, the HSB will shut down and re-start will be disabled. RED LEDs on the module and enclosure exterior are lit.

Check the oil level. The oil level should be at the FULL mark, if necessary, add oil. DO NOT overfill. Inspect the unit for a possible oil leak, if a leak is discovered, contact Champion or your nearest Authorized Champion Dealer. Follow the reset procedures contained in the manuals specific to your model to clear and correct.

OVER CRANK LED

The RED LED will be lit if the engine failed to start after 5 attempts. This prevents the HSB from damaging itself or other related components. When the fault is detected, the HSB will shut down and re-start will be disabled. RED LEDs on the module and exterior are lit.

This failure could be the result of insufficient fuel supply. Check the in-line fuel shut off valves and make sure they are in the ON/ OPEN position. Position them in the correct position, follow the reset procedures contained in the manuals specific to your model to clear and correct. If they are in the correct position and the HSB shows a fault light again, it's recommended to perform a Monometer pressure check by an Authorized Champion Dealer or installer. This will make sure the correct amount of fuel is being delivered to the HSB when it starts.

Insufficient battery output could result in poor cranking cycles, not permitting the engine starter to reach optimum starting RPM to start the engine. This can be verified by checking the Battery Charger LED, NO CHARGE. If this occurs, the individual battery voltages must be checked to determine if the battery is properly charged or if it has failed. It is extremely important to follow all cautions and warning per the battery manufacturer concerning installation, service, maintenance and replacement procedures.

RUN LED

The GREEN LED will be lit if the engine is running and is only lit when the engine is running.

POWER LED

The GREEN LED will be lit, indicating the HSB is working correctly and loads can be connected or transferred to it. It is only lit when the HSB is running.

INSTALLATION

LED INDICATORS

In all cases when the LED is GREEN, this is an indicator that the HSB is performing properly.

In all cases when the LED is RED, this is an indicator that the HSB has registered a fault and must be corrected. Only the "LOW BATTERY LED" will not latch out or shut down the HSB. ALL other RED LED faults will latch out, shut down, disable starting and light the RED LEDs on the Engine Control Module and the exterior fault code LED on the backside of the HSB.

APPROXIMATE ENGINE STARTER CRANK CYCLE TIMES

10 seconds ON

10 seconds OFF

10 seconds ON

10 seconds OFF

10 seconds ON

10 seconds OFF

10 seconds ON

10 seconds OFF

10 seconds ON

If the HSB fails to start, the "OVER CRANK LED" will be lit on the Engine Control module and the exterior fault code indicator LED on the backside of the HSB.

/// PIN LOCATIONS

(ON BACKSIDE OF THE CONTROLLER)

The pins relate to a function of the Engine Controller module. These functions control the operation of the HSB and ATS. The ECM continually monitors the Utility source power 24/7. There are only 14 pin locations. Remember the LEDs on the front side of the module are only indicators of a run (GREEN) or fault (Red). These are the designated pin locations, function and wire colors for reference;

1. Pin 1 B+ W(White)



2. Pin 2 B- G (Green)
3. Pin 3 Motor start signal B/W (Black/White)
4. Pin 4 Fuel valve G/B (Green/Black)
5. Pin 5 Drives all fault lights L (Blue)
6. Pin 6 Ground/stop L/B (Blue/Black)
7. Pin 7 Signal to alternator R/B (Red/Black)
8. Pin 8 Not Connected
9. Pin 9 Low Oil Level/ Pressure Y (Yellow)
10. Pin 10 Engine High Temp Br (Brown)
11. Pin 11 Exercise O/B (Orange/Black)
12. Pin 12 Signal to ATS O (Orange)
13. Pin 13 Frequency Over/ Under B (Black)
14. Pin 14 Frequency Over/ Under R (Red)

DIP SWITCHES ON THE BACK SIDE OF THE CONTROL IN BETWEEN THE 2 ROWS OF PIN CONNECTORS

The Dip Switches assist the ECM by setting parameters of control such as delays of time or intervals for signals. There are only 10 dip switches. These are the designated "ON" or "OFF" position settings for the dip switches (factory pre-set);

1. 1 – 7 are all in the "OFF" position
2. 8 is the only dip switch in the "ON" position
3. 9 – 10 are in the "OFF" position

ATS CONTROL MODULE

The ATS Control Module contains the TEST/AUTO/OFF switch and LEDs that indicate the type/source of power delivery into the home. The module will reflect Utility power source when the utility power source is coming into the home. The 3 LEDs on the left will be lit (UTILITY, ATS active, LOAD, view left to right).

The module will reflect GENSET power when the Generator is the source of power being delivered into the home. The 3 LEDs on the right will be lit (LOAD, ATS active, GENSET, view center to right).

This is a two (2) wire start system. The control of HSB operation and ATS operation are done through the controls in the HSB. This is done by a wire connection to the HSB and then a wire correction from the HSB to the ATS. All system communications,

INSTALLATION

monitoring of the Utility power source and control of the HSB are coordinated through the control modules on the HSB. A one (1) wire start is a system in which the communications, monitoring and control of power source is done through the ATS.

/// TEST/AUTO/OFF SWITCH

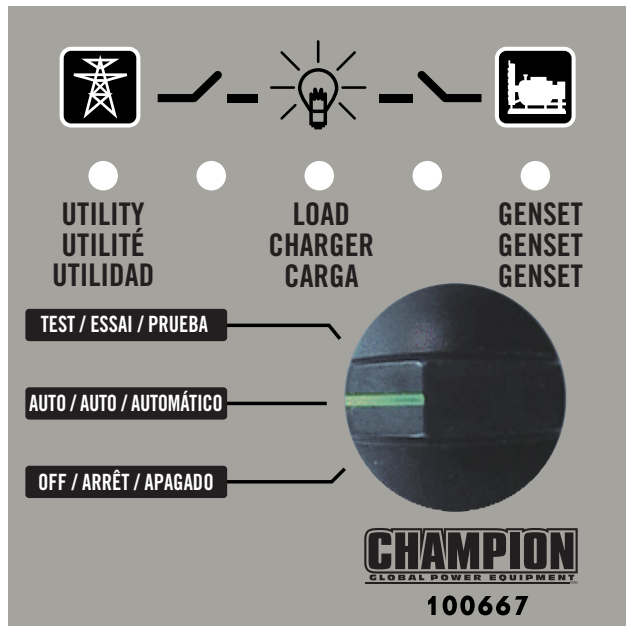

TEST – This position allows verification that the HSB power delivery circuit is functional. With the switch in the TEST position, the engine will start and the ATS will transfer from Utility power to the HSB power. Safety procedures should be followed.

Prior to placing the ATS Control Module in the “TEST” position, the UTILITY, ATS active and LOAD LEDs will be lit.

Placing the ATS Control Module in the “TEST” position will command the HSB to start and to transfer the power source from utility power to the HSB power. The LOAD, ATS active and GENSET LEDs will be lit (view center to right).

AUTO – This position allows automatic delivery of power from the HSB when there is a Utility power source outage. With the switch in the AUTO position and the HSB not running (in standby mode), the UTILITY, ATS active and LOAD LEDs will be lit (view left to right), this indicates the household is using Utility power source. This position is the standby ready position.

OFF – This position will not allow any power to be delivered or transferred to the ATS or the household when the engine (HSB) is running.

The UTILITY, ATS active and LOAD LEDs will remain lit, indicating the Utility power source is providing power to the household. If the Utility power source is turned off (main line breaker is turned “OFF”) or if a Utility power source failure occurs, NO LEDs will be lit if the ATS Control Module is in the “OFF” position.

/// PIN LOCATIONS

ON THE BACKSIDE OF ATS CONTROL MODULE



The pin locations are relate to the interaction/communication between the Engine Controller, the ATS Control Module and the ATS. There are only 16 pin locations, two rows of 8. When installing the pin connection plugs, the top plug is wired RED, GREEN, RED, viewed left to right. This will eliminate incorrect installation. These are the designated pin locations, function and wire colors for reference;

1.	Pin 1	B+	R (Red) top row (viewed left to right)
2.	Pin 2	B-	G (Green) top row
3.	Pin 3	Utility close	R (Red) top row
4.	Pin 4	Utility close	B/W (Black/White) top row
5.	Pin 5	Gen-set close	L (Blue) top row
6.	Pin 6	Gen-set close	R (Red) top row
7.	Pin 7	B-	G (Green) top row
8.	Pin 8	Start ATS	O (Orange) top row
9.	Pin 9	Gen-set C.B.	G/B (Green/Black)
10.	Pin 10	Utility C.B.	Y (Yellow)
11.	Pin 11	Utility AC Detect	Pu (Purple)
12.	Pin 12	Utility AC Detect	O (Orange)
13.	Pin 13	Load AC Detect	P (Pink)
14.	Pin 14	Load AC Detect	Br (Brown)
15.	Pin 15	Gen AC Detect	B (Black)

INSTALLATION

16. Pin 16 Gen AC Detect R (Red)

DIP SWITCHES on the backside of the control, between the 2 rows of pin connectors

The Dip Switches set parameters of the controller for delay sequences. There are only 10 dip switches. These are the designated “ON” or “OFF” position settings for the dip switches;

1. Position 1 is in the “ON” position
2. Position 2 is in the “ON” position
3. Positions 3 – 9 are in the “OFF” position
4. Position 10 is in the “ON” position

These are factory set delays or activation signals.

BATTERY CHARGER

This automatic battery charger is an intelligent module which maintains lead acid batteries at a full charge, when the HSB has been properly installed. Continual monitoring and maintenance will promote long battery life. In accordance with the principle of high efficiency, at Full Load, >85% of efficiency is achieved. This charger is a maintenance battery charger. If the battery voltage falls below 6V, the charger will not re-charge the batteries. To properly maintain battery efficiency you must follow the battery manufacturers; safety instructions, warnings and proper maintenance procedures.

Feature benefits include; reverse polarity protection, short circuit protection, overload protection, over voltage, over current, floating charging system, constant voltage output and a rugged design for industrial environments. The charger is also equipped with a manual reset which is located on the far right side of the wire land points. This charger is for lead acid batteries only. All adjustments are preset at the factory.

The automatic battery charger has five (5) built in LEDs that display the following, view left to right;

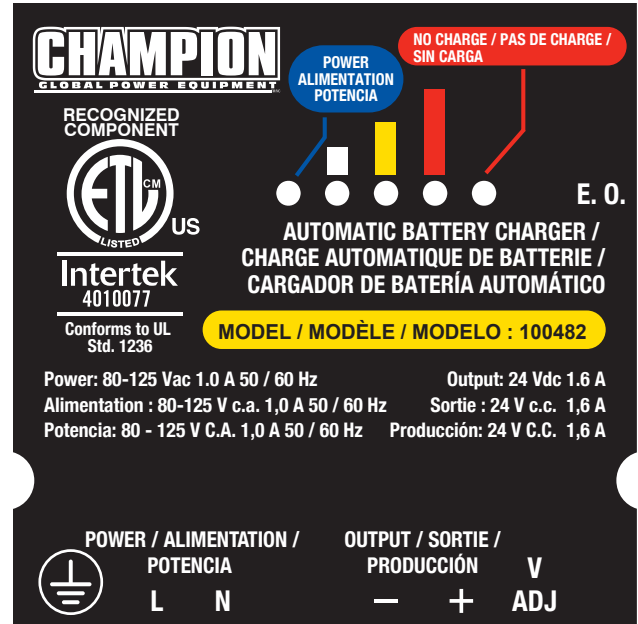

1. Power – Lit to indicate the battery is fully charged.
2. Small Bar – Lit to indicate the battery is receiving a trickle charge.
3. Middle Bar – Lit to indicate current output is near 50%.
4. Large Bar – Lit to indicate the charger is operating above 50% capacity.
5. NO CHARGE – Lit to indicate a battery charging problem. If this LED is lit, the LED on the Engine Controller module, “LOW BATTERY” will also be lit.

The battery(s) might be discharged to a level that is too low to re-charged with this charger (battery voltage below 6V). If this is the case, the batteries will need to be charged individually. Remove all battery cables from the batteries and follow the battery manufacturers’ instructions on properly servicing/charging the batteries.

Be careful to avoid corrosion on the battery post(s). Corrosion can have the effect of creating an insulation between the post(s) and the cable(s), this will severely affect the performance of the battery. Follow battery manufacturers’ instructions on proper maintenance, service or replacement. The correct wire lands are read left to right, 6 land points;

INSTALLATION

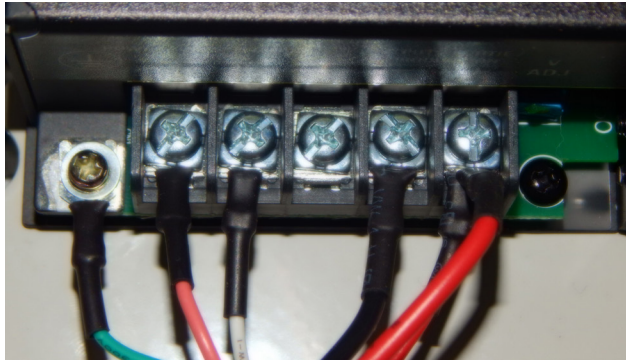

- | | | |
|-----------------|---------------|-----------|
| 1. Wire land #1 | Ground | G (GREEN) |
| 2. Wire land #2 | L1 | P (PINK) |
| 3. Wire land #3 | N | W (WHITE) |
| 4. Wire land #4 | NOT CONNECTED | EMPTY |
| 5. Wire land #5 | B- | B (BLACK) |
| 6. Wire land #6 | B+ | R (RED) |

HSB TEST

/// VOLTAGE CHECKS – NO LOAD

1. With the Engine Control Module and ATS Module both in the OFF position.
2. Turn ON the utility power supply to the ATS.
3. With an AC voltmeter, check for the correct voltage. Single-phase utility power supply. Measure across the UTILITY SUPPLY ATS terminal lugs L1 and L2. Also check L1 to NEUTRAL and L2 to NEUTRAL.

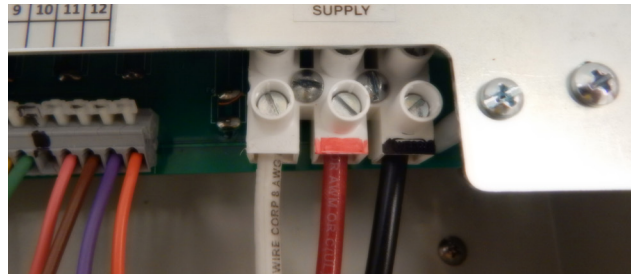

4. The utility supply voltage should be correct and compatible with the ATS ratings.
5. Turn OFF the utility power supply to the ATS.
6. The Control Panel MAIN CIRCUIT BREAKER must be in the OFF position.
7. Set the ATS module in the test mode.
8. Set the Engine Control Module in the MANUAL mode. The HSB will crank and start. Let the HSB warm up at no load for 5 minutes to stabilize performance.
9. Set the Control Panel MAIN CIRCUIT BREAKER in the ON position.

DANGER

Proceed with caution. Once the Utility Power is turned ON, the ATS is now electrically hot. The feeder lines and terminals are now live. Contact with these connections will result in extremely hazardous and possibly fatal electrical shock. Use the correct procedures as described in national electrical codes.

DANGER

Proceed with caution. HSB generator output voltage is now being delivered to the ATS and is electrically hot. The feeder lines and terminals are now live. Contact with these connections will result in extremely hazardous and possibly fatal electrical shock.

WARNING

The manufacturer recommends that a licensed electrician or an individual with complete knowledge of electricity perform these procedures.

10. With an AC voltmeter, check the correct voltage. Single-phase generator supply.
11. Measure across GENERATOR SUPPLY ATS lugs L1 and L2. Also check L1 to NEUTRAL and L2 to NEUTRAL. These are factory pre-set limits.

INSTALLATION

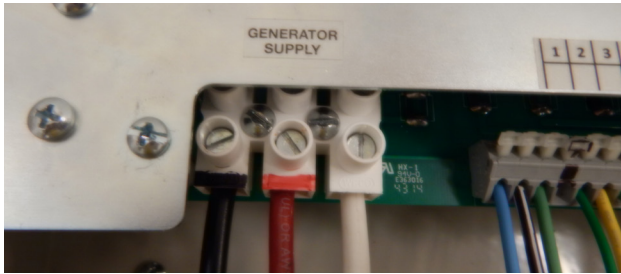

Frequency	63 Hertz
Terminals L1 to L2	230 VAC
Terminals L1 to NEUTRAL	115 VAC
Terminals L2 to NEUTRAL	115 VAC

12. Set the HSB generator MAIN CIRCUIT BREAKER to its OFF position.
13. Set the Engine Control Module and ATS Module to the OFF position. This will shut off the HSB

Do NOT move forward until the HSB generator AC output voltage and frequency are correct and within the stated limits.

1. If the no-load voltage is correct but no-load frequency is incorrect, the engine governed speed requires adjustment. Locate the governor arm bolt, turn the bolt clockwise to increase RPM, counter clockwise to decrease RPM. No-load RPM should be set at 3,780 RPM. The adjustments should be made in ¼ turn increments. No-load Hertz should read 63 Hertz.



2. If no-load frequency is correct but voltage is not, the voltage regulator (AVR) may require adjustment. Remove the back electrical/fuel access panel. Locate the voltage regulator (AVR) on the right inside wall. The AVR has a slotted potentiometer for adjustment. With the frequency set at 63 Hertz, slowly turn the slotted potentiometer clockwise until voltage reads 230.



/// HSB TESTS UNDER LOAD

DURING THIS TEST YOU DO NOT NEED TO TURN OFF ANY CIRCUIT BREAKERS IN THE UTILITY MAIN DISTRIBUTION PANEL, HSB CONTROL PANEL OR THE ATS.

This procedure will verify load Voltage and frequency output. Prior to starting the test you can place a Manometer in line to check fuel flow when the HSB is under complete load.

1. Set the Engine Control Module in the ATS position.
2. Set the ATS Control Module in the TEST position.
3. With the switch in the TEST position, the engine will start and the ATS will transfer.
4. The GENSET LED, ATS LED (middle LED) and the LOAD LED will be lit, indicating the HSB generator power delivery circuit is functional. The standby circuits from the ATS to the Utility Main Distribution Panel are now powered by the HSB and not the Utility.

All other electrical circuits in the home are powered by Utility power and remain active during this test procedure. This test provides HSB power to the designated standby circuits as it would during a Utility power outage.

5. During this simulation test, all standby circuits will provide full rated wattage/ampere capacity demands to the HSB. DO NOT OVERLOAD.

WARNING



The manufacturer recommends that a licensed electrician or an individual with complete knowledge of electricity perform these tests.

6. With rated load applied, check voltage and frequency across ATS GENERATOR SUPPLY terminals L1 and L2. Voltage should be greater than 216 Volts.
7. Frequency should be greater than 57 Hertz.

INSTALLATION

8. Verify that the gas pressure remains within the acceptable parameters as listed in the manual, provided that you placed a Manometer in line prior to starting this test.
9. Let the HSB run under load for at least 30 minutes. With the unit running listen for unusual noises, inspect for vibrations or other unusual items that might reflect a problem.
10. When the test process is completed, switch the ATS Control Module to the ATS position. The ATS will transfer back to UTILITY SUPPLY, this will power all circuits of the home.
11. The HSB will run through a cool down cycle, shut down and return to standby mode.

The test is now complete and the system is in standby mode.

CHECKING AUTOMATIC OPERATION

To check the HSB system for proper automatic operation, proceed as follows:

1. Ensure the HSB is set in the OFF positions on both the Engine Control Module and the ATS Module.
2. Install front cover of the ATS.
3. Return the Engine Control Module and the ATS Module to their ATS positions. The HSB system is now ready for automatic operation.
4. Turn OFF the Utility Main Circuit Breaker.
5. The engine should crank and start when the utility power source is turned OFF.
6. After starting, the ATS should connect load circuits to the GENERATOR SUPPLY. Let the HSB system operate through its entire automatic sequence of operation.
7. Once the HSB system has run through its automatic sequence of operation. Turn on the Utility Main Circuit Breaker. The ATS should automatically transfer from GENERATOR SUPPLY to UTILITY SUPPLY.
8. The HSB will run through a cool down cycle, shut off and be in standby ready mode.
9. This check is now complete.

CUSTOMER FAMILIARIZATION-SUMMARY

It's important to educate the home owner on proper maintenance, operation and service call procedures. A properly educated home owner can reduce unnecessary service trips and phone calls.

Ensure that the installation of the HSB and ATS has been correctly performed as outlined by the manufacturer and that it meets all applicable codes.

Test and confirm proper operation of the HSB and ATS system as outlined in the appropriate installation and owner's manuals.

Educate the home owner on the location and operation of;

1. Full flow shutoff valve
2. Automatic operation of the HSB system
3. Engine Control Module and LED indicators
4. ATS Module and LED indicators
5. Battery Charger and LED indicators
6. Exterior fault code indicator LED on the backside of the HSB
7. ATS operation
8. Exercise scheduled time of operation
9. Scheduled Maintenance
10. Fill out and provide the customer a copy of the HSB, ATS model & serial number reference. This information is extremely important for part purchases and service information, these numbers are specific to each HSB and ATS.
11. Fill out and provide the customer a copy of the ATS back-up circuits.
12. Fill out the Circuit Label inside the ATS.

It's always a good business practice to place business cards in the Owner's and Installation manuals and place dealer stickers on the HSB and ATS for the customer's reference.

NOTICE

By law it is required in many states to have a Carbon Monoxide (CO) detector in operating condition in your home. Carbon Monoxide detector(s) must be installed and maintained indoors according to the manufacturer's instructions. A CO monitor is an electric device that detects hazardous levels of CO. When there is a buildup of CO, the monitor will alert the occupants by flashing a visual light indicator and an audible alarm. Smoke alarms cannot detect CO gas.

CO gas is odorless, colorless and tasteless and is unlikely to be noticed until a person is overcome. Standby generators emit carbon monoxide (CO) gas in the engine exhaust.

INSTALLATION



HSB, ATS MODEL & SERIAL REFERENCE ATS BACK-UP CIRCUITS

HSB Model Number _____

HSB Serial Number _____

Fuel Type LP _____ NG _____

ATS Model Number _____

ATS Serial Number _____

ATS circuits powered _____

_____	_____
_____	_____
_____	_____
_____	_____
_____	_____
_____	_____
_____	_____

Date Installed _____

Dealer/Installer _____

Address _____

Phone _____

Cell _____

Purchased from _____

AUTOMATIC TRANSFER SWITCH (ATS)

Refer to the Reliance instruction guide enclosed with each unit for information related to installation, operation, service, trouble shooting and warranty (Champion part number 101271).

The most reliable and convenient method to transfer power is with an automatic transfer switch (ATS). The ATS will automatically disconnect the home from the utility power prior to the HSB functioning (see NEC 700, 701 and 702). Failure to disconnect the home from the utility with an approved UL listed ATS can result in damage to the HSB and can also cause injury or death to utility power workers who may receive electrical back-feed from the HSB.

ATS module switch (located in the HSB control panel) includes sensors to detect when a power failure (utility lost) occurs. These sensors trigger the ATS to disengage the home from the utility power. After the home disconnected from the utility, the HSB engine will start. When the unit reaches the proper voltage and frequency, the ATS will automatically transfer generator power to the pre-determined load circuits that have been selected and connected to the transfer switch.

The ATS module continues to monitor the utility source for the return of utility power. When the utility power returns, the ATS disengages the home from generator power and re-transfers the home to utility power. The HSB is now off line and will shut down--returning to the standby mode.

The Champion Fast/Tran is an automatic transfer switch (ATS) designed to provide a safe and simple method of powering designated branch circuits from a permanently installed back-up AC power source. The electrical-over-mechanical transfer switching and interlocking system prevents accidental feedback of backup power to the utility lines. The extremely high speed switching system avoids the electrical appliance shutdowns that can occur with other transfer switches when transitioning from back-up power to utility power.

NEMA 1 – This type of enclosed ATS is for indoor installations only.

NEMA 3R – This type of enclosed ATS is similar to the indoor box, except that it is a weatherproof enclosure and required for exterior installations by code. The enclosure only has knockouts on the bottom side for the enclosure, requires water tight fasteners/grommets when installed outside per code. This enclosure can also be used inside.

The ATS is also equipped with manual transfer switch operation which is generally utilized for system checks and function tests of the system, refer to manual.

The HSB is also equipped with a standard weekly test that starts the unit automatically at a specific set time, once every 7 days (set by installer or owner) and exercises the HSB unit. It does not transfer loads to the generator, this exercise is a systems check, refer to manual

/// UNPACKING

Allow the ATS to warm to room temperature for at least 24 hours before unpacking to prevent condensation on the electrical apparatus. Use care when unpacking to avoid damaging transfer switch components. Use a vacuum cleaner or a dry cloth to remove dirt and packing material that may have accumulated in the transfer switch or any of its components.

Do not use compressed air to clean the switch. Cleaning with compressed air can cause debris to lodge in the components and damage the switch per the ATS manufacturer.

Retain the ATS manual with or near the ATS for future reference.

/// LOCATION AND MOUNTING

Install the ATS as close as possible to main utility distribution panel. Wires will run between the utility main distribution panel and the ATS, proper installation and conduit is required by code. Mount the ATS vertically to a rigid supporting structure. To prevent the ATS or enclosure box from distortion, level all mounting points, use washers behind the mounting holes (outside the enclosure, between enclosure and supporting structure).

/// CIRCUIT BREAKERS FOR UTILITY MAIN CONTROL PANEL AND ATS

The Utility Main Control Panel requires a 35.5 ampere double-pole circuit breaker as a feeder for the ATS. Refer to inside label/decals on the ATS enclosure front panel for recommendations.

ATS branch circuit breakers must match the Utility Main Control breakers amp rating to which they will provide power outage. Refer to the inside label/decals on the ATS front panel for recommendations.

INSTALLATION

/// ELECTRICAL GROMMET(S)

Grommets can be used in any enclosure knockout for NEMA 1 installations. Grommets can only be used in the bottom enclosure knockouts for NEMA 3R installations, when installed outside.

/// INSTALLATION WIRING FOR ATS TO UTILITY MAIN CONTROL PANEL

WARNING



The manufacturer recommends that a licensed electrician or an individual with complete knowledge of electricity perform these procedures. Be certain that the power from the main panel is turned “OFF” and all backup sources are locked out prior to removal of the cover or removal of any wiring of the utility main electrical distribution panel. Failure to do so could result in serious injury or death. Automatic start generators will start upon loss of utility main power unless locked in the “OFF” position.

WARNING



The wires connected to the service main circuit breaker remain LIVE and HOT. Avoid contact with these wires and the service main circuit breaker connection lugs.

CAUTION

Consult all local and National electric codes for proper wiring methods for all wiring.

1. Conductor sizes must be adequate to handle the maximum current to which they will be subjected. The installation must comply fully with all applicable codes, standards and regulations. Conductors must be properly supported, of approved insulation materials, protected by

approved conduit and with the correct wire gauge size in accordance with all applicable codes. Before connecting wire cables to terminals, remove any surface oxides from the cable ends with a wire brush. All power cables must enter the enclosure through the enclosure knockouts.

2. Determine where the flexible, liquid tight conduit will pass through the building from the inside to outside. When you are certain that there is adequate clearance on each side of the wall, drill a small pilot hole through the wall to mark the location. Drill an appropriate sized hole through the sheathing and siding.
3. In compliance with all local electrical codes, route the conduit along ceiling/floor joists and wall studs to the location where the conduit will pass through the wall to the exterior of the house. Once the conduit is pulled through the wall and in proper position to attach to the HSB generator, place silicone caulk around the conduit on both side of the hole, inside and outside.
4. Mount the ATS next to the Utility main circuit control panel board (circuit breaker or fuse box). Install a large diameter conduit (1 or 1 ¼ inch, trade size recommended, liquid tight, (1 foot suggested distance) between the two panels. Install a 50 ampere double-pole circuit breaker in the Utility main circuit control panel.
5. Strip wires ½ inch and install a Black L1, and Red L2 wire suitable for 50 amperes between the double-pole feeder breaker in the main panel and the similarly-colored terminals on the Utility Supply terminal block in the ATS. Install an insulated White wire of the same AWG between the neutral bar in the main panel and the White terminal on the Utility Supply terminal in the ATS. The Neutral wire must be the ampacity as the L1 and L2 power wire. Install a suitable Ground wire between the ground busses in the two panels.
6. Select the circuits to be powered by the HSB backup generator. If the branch circuit conductor is long enough, you may want to pull it from the main panel board and reinstall it in the ATS. It is possible to use an additional wire and wire connector to extend the branch conductor in the main panel board through the conduit into the ATS. Install the branch circuit breakers in the ATS panel for those branch circuits to be powered by the generator. The ATS is UL listed for a number of 1 inch interchangeable breakers (see label on the inside cover of the ATS). If the breakers are moved from the Utility main panel board to the ATS, make certain the openings in the dead front created by removing those breakers from the main panel board are fitted with the appropriate filler plugs. Connect each branch circuit conductor to its appropriate branch circuit breaker. Repeat for each of the selected circuits.

INSTALLATION

The branch conductors must be connected to the same ampacity (size) breakers as they were when they were in the main panel. Make sure that the total ampacity of the selected circuits does not exceed the maximum capacity of the generator.

7. Circuits to be moved must be protected by the same size breaker. For example, a 15 amp 120 volt circuit in the ATS will replace a 15 amp 120 volt circuit in the main utility control panel. 15 amp breakers utilize 12 gauge wire to allow for easy replacement with 20 amp breakers is required by the installation without the need to replace/upgrade the wire size.
8. Balance must be maintained when moving circuit locations from utility main distribution panel to standby ATS. Circuit breaker positions alternate buss bars vertically. Circuits sharing a neutral wire should be moved together in adjacent positions in the ATS or not moved. If unsure of the proper procedure or if the installation differs from that described, consult a licensed professional at this time.
9. Strip wire ½ inch and install a Black L1, Red L2, and White neutral wire suitable for 50 amperes between the power output connector on the generator (terminal block #3) and the similarly-colored terminals on the Generator Supply terminal block in the ATS. If the generator has a ground connector, install a ground wire between the generator and the ground bus in the TS.

/// INSTALLING COMMUNICATION WIRES

1. All Communication circuit wires are color coded for easy identification.
2. Route the multi-conductor wires (cable) from the HSB generator (terminal block #3) to the 12 position center terminal block in the ATS. Strip the wires ¼ inch and connect each wire to the terminal block in the sequence from left to right starting with 1 in the left-most position. Each wire is connected by pushing the nylon release lever backward to open the terminal clamp. Inserting the stripped wire into the terminal opening, releasing the terminal clamp. Care should be taken not to overstress the nylon release levers. Note that some of the terminal block positions are deliberately left unused (TB2-4 and TB2-8).



Terminal Block Position	Function	Voltage	Wire Color
TB2-1	Switch to generator signal	+24 VDC	L (Blue)
TB2-2	Switch to utility signal	+24 VDC	B/W (Black/White)
TB2-3	Switch to – common return	0 VDC	G (Green)
TB2-4	UNUSED		
TB2-5	Generator position micro switch	Switch closure	G/B (Green/Black)
TB2-6	Utility position micro switch	Switch closure	Y (Yellow)
TB2-7	Position micro switch common	Switch closure	G (Green)
TB2-8	UNUSED		
TB2-9	Load bus line 1 out	120 VAC	P (Pink)
TB2-10	Load bus line 2 out	120 VAC	Br (Brown)
TB2-11	Utility line 1 out	120 VAC	Pu (Purple)
TB2-12	Utility line 2 out	120 VAC	O (Orange)

/// COMMISSIONING THE ATS

1. Turn “OFF” all of the distribution breakers in the ATS.
2. Manually switch the ATS to utility position by moving the manual lever to the position marked “UTILITY”.
3. Turn “ON” the feeder breaker in the utility distribution panel.
4. Turn “ON” all distribution breakers and verify that all connected circuits are functioning properly.
5. Remove the lock-out apparatus if installed or equipped, and arm the HSB.
6. Your ATS is now fully functional.
7. To test the ATS performance, simply disable utility mains power. Your HSB generator should start, and your ATS will automatically switch to the “GENERATOR SUPPLY” source. When utility mains power is re-established, your ATS will automatically switch back to the “UTILITY SUPPLY” source,

INSTALLATION

your HSB generator will cool down, turn off and then be placed into standby ready position.

8. Refer to the Owner's and Installation manuals provided with the HSB and ATS for additional testing information.
9. The installer must label the circuits in the ATS for reference with the label enclosed with ATS. The customer information/reference list should also be listed with this information.
10. All manuals, labels and lists should be kept in or close to the ATS.

ATS CIRCUIT BOARD FUSE INFORMATION

WARNING



The power from "BOTH" the UTILITY power source and the HSB "MUST" be turned "OFF" before attempting to identify or replace any fuses. Failure to do so could result in serious injury or death.

On the backside of the ATS circuit board there are six (6), BUSS AGC 6 amp fuses. Should any of these fuses blow, the generator controller will need to be inspected and serviced by a qualified technician. Once the cause of the blown fuse is resolved, the fuse will need to be replaced.

To access the fuses on the rear of the circuit board, remove the 4 screws (parts 5 and 6, refer to ATS manual) from the mounting bracket, and remove the 2 screws from the buss bar (parts 1 and 2, refer to ATS manual). To access these screws, the branch circuit breakers will need to be pulled off (removed) from the buss bar first. The entire buss bar and mechanism assembly now can be tilted away from the cabinet (toward you), providing access to the rear of the circuit board and fuses.

Fuse identification, left to right (refer to ATS manual)

1. F1 Utility Solenoid
2. F2 Utility L2 out
3. F3 Utility L1 out
4. F4 Load Buss L2 out
5. F5 Load Buss L1 out
6. F6 Generator solenoid

ATS FUSE TROUBLESHOOTING AND TESTING

/// FUSES F2 AND F3

1. If the systems controller shows that load voltage is available. Fuses F2 and F3 are functional.
2. If not, disconnect the wires that are connected to terminals 9 and 10 on the 12- position terminal block.
3. With the Utility power on, verify the fact that all circuits connected to the ATS are energized. Connect an AC voltmeter between terminals 9 and 10.
4. If the voltmeter reads approximately 240 VAC, fuses F2 and F3 are functional.
5. Remove the voltmeter and reconnect the wires that were installed in terminals 9 and 10, in the correct order.

/// FUSES F4 AND F5

1. If the system controller shows that the utility voltage is available, fuses F4 and F5 are functional.
2. If not, disconnect the wires that are connected to terminals 11 and 12 on the 12-position terminal block.
3. With utility power on, verify the fact that all circuits connected to the ATS are energized. Connect and AC voltmeter between terminals 11 and 12.
4. If the voltmeter reads approximately 240 VAC, fuses F11 and F12, are functional.
5. Remove the voltmeter and reconnect the wires that were installed in the terminals 11 and 12, in the correct order.

/// FUSE F1

1. If the system controller will switch the transfer switch from utility to generator and back, fuse F1 is functional.
2. If not, disconnect the wires that are connected to terminals 1, 2, and 3 on the 12-position terminal block.
3. With utility power on, verify the fact that all circuits connected to the ATS are energized. Connect the negative lead of the 24 VDC power supply to terminal 3.
4. FOR NO MORE THAN 1 SECOND, press the positive lead of the 24 VDC power supply to terminal 1. If the solenoid clicks and the mechanism transfers, fuse F1 is functional.

5. Disconnect the 24 VDC power supply and reconnect the wires that were installed in terminals 1, 2 and 3, in the correct order.

/// FUSE F6

1. If the system controller will switch the transfer switch from utility to HSB generator and back, fuse F6 is functional.
2. If not, disconnect the wires that are connected to terminals 1, 2 and 3 on 12-position terminal block.
3. With utility power on, verify the fact that all circuits connected to the ATS are energized.
4. Connect the negative lead of a 24 VDC power supply to terminal 3.
5. FOR NO MORE THAN 1 SECOND, press the positive lead of the 24 VDC power supply to terminal 2.
6. If the solenoid clicks and the mechanism transfers, fuse F2 is functional.
7. Disconnect the 24 VDC power supply and reconnect the wires that were installed in terminals 1, 2 and 3, in the correct order.

MANUAL TRANSFER SWITCH

WARNING



A manual switch is NOT approved by code when used with a stationary or permanently installed HSB generator. You MUST install an ATS when used with a stationary or permanently mounted HSB generator by code.

All applicable codes must be followed. The manufacturer of the switch provides detailed instructions that must be followed (Champion manual part number 101271). The Champion HSB requires the installation of a Champion approved ATS.

CAUTION

For stanby service, connect output of generator to a suitably rated transfer switch in accordance with the Canadian Electrical Code, Part 1.

TROUBLESHOOTING

TROUBLESHOOTING HSB

The number one problem which relates to starting, output and performance is "Fuel Pressure Insufficient". Utility fuel regulator and pipe sized to small which can be compounded by pipe run distance to long for the size of pipe installed. Confirm fuel pressure to the fuel regulator during No-load and Load operation.

ENGINE WILL NOT CRANK/TURN OVER

- | | |
|--|--|
| 1. HSB set in "OFF" mode. | Place the HSB controllers in the proper AUTO and ATS start positions. |
| 2. Battery not connected or loose, corroded posts or wires | Connect the batteries according to owner's manual, clean and tighten the battery connections |
| 3. Battery(s) not charged or low charge. | Recharge or replace battery(s). |
| 4. Check for active fault code. | Identify fault code, correct and reset. |
| 5. Defective starter solenoid * | |
| 6. Defective starter * | |

GENERATOR WILL CRANK/TURN OVER BUT WILL NOT START

- | | |
|---|--|
| 1. Check for active fault code. | Identify fault code, correct and reset. |
| 2. Fuel valve(s) turned off. | Turn on fuel supply. |
| 3. Fuel pressure insufficient*. | Manometer check, confirm fuel pressure to fuel regulator*. |
| 4. Weak battery(s). | Recharge or replace battery(s) |
| 5. Low oil level. | Check for oil leaks. Check the oil level and add oil if necessary. |
| 6. Spark plug wire is disconnected. | Connect spark plug wire. |
| 7. Defective fuel solenoid/regulator. * | |

ENGINE STARTS, RUNS ROUGH

- | | |
|--|---|
| 1. Fuel pressure insufficient*. | Manometer check, confirm fuel pressure to fuel regulator*. |
| 2. Wrong fuel jets. | Check jets for NG or LPG, change to correct Master Mixer fuel jets. |
| 3. Faulty spark plug, loose spark plug wire. | Change spark plug, set gap, connect wire. |
| 4. Plugged air cleaner | Clean or replace air cleaner. |
| 5. Generator overloaded*. | Remove one or more loads*. |
| 6. Shorted circuit * | |

HSB STARTS, THEN SUDDENLY STOPS

- | | |
|---|--|
| 1. Check for active fault code. | Identify fault code, correct and reset. |
| 2. Fuel supply insufficient* | Manometer check, confirm fuel pressure to fuel regulator*. |
| 3. Low oil, pressure shut down | Check for oil leaks. Check the oil level and add oil if necessary. |
| 4. Generator over loaded | Turn off standby circuits for house, reset fault, place unit back into AUTO and ATS mode. Turn on standby circuits for house. If problem returns contact Champion or Champion service dealer*. |
| 5. Engine high/over temperature shut down | Check all intake and exhaust ventilation around the HSB, remove all debris. Let HSB sit for 30 minutes to cool down. |

NO AC OUTPUT

- | | |
|---|---------------------------------|
| 1. HSB set in "TEST" mode | Place HSB in AUTO and ATS mode. |
| 2. Circuit breaker in "OFF" position | Turn on breaker. |
| 3. ATS control in "OFF" mode | Place ATS module in ATS mode. |
| 4. Main circuit breaker in "OFF" position. | Turn on breaker. |
| 5. Transfer switch breaker in "OFF" position. | Turn on breaker. |
| 6. Standby breakers set in "OFF" position. | Turn on breaker. |
| 7. Line circuit tripping breaker because of short circuit * | |
| 8. Line circuit tripping breaker because of overload * | |
| 9. Poor wiring connections* | |
| 10. ATS problems* | |

LED INDICATORS

In all cases when the LED is GREEN, this is an indicator that the HSB is performing properly.

In all cases when the LED is RED, this is an indicator that the HSB has registered a fault and must be corrected. Only the "LOW BATTERY LED" will not latch out or shut down the HSB. All other RED LED faults will latch out, shut down, disable starting and light the RED LEDS on the Engine Control Module and the exterior fault code light on the backside of the HSB.

RESET FAULT CODE(S)

There is an exterior fault code indicator light located on the back of the enclosure. This should be checked weekly to make sure there are no active fault codes.

The fault code(s) can be reset by placing the Engine Control Module in the OFF position for 10 seconds and then placed into ATS mode. This will reset fault LED, however if a fault code(s) re-occurs it must be addressed.

BATTERY(S) NO OR LOW LEVEL CHARGED, BATTERY(S) DEAD, NEEDS REPLACEMENT, THE EXERCISE TIME MUST BE RESET ONCE THE BATTERY(S) HAVE BEEN DISCONNECTED.

*Contact Champion Power Equipment, Technical Service toll free 1-877-338-0999,

tech@championpowerequipment.com or your nearest Champion dealer.

www.championpowerequipment.com



Champion Power Equipment

12039 Smith Ave.

Santa Fe Springs, CA 90670 USA

Made in China



10 Year Limited Warranty* Basic Warranty Provisions

Champion Air-Cooled 8.5kW – 20kW Home Standby Units USA and Canadian Models

For a period of 10 years or 2000 hours (whichever occurs first) from successful activation by an Authorized Champion Home Standby Dealer, Champion Power Equipment will, at its option, repair or replace any part(s) which upon examination, inspection and testing by Champion Power Equipment or an Authorized Champion Home Standby Dealer is found to be defective under normal use and service, in accordance with the Warranty Schedule set forth below.

Any equipment that the purchaser/owner claims to be defective must be examined by the nearest Authorized/Certified Champion Home Standby Service Dealer. This warranty applies only to Champion Power Equipment automatic standby generators used in "Standby" applications as Champion has defined Standby. Scheduled Maintenance, as outlined by the generator owner's manual is required. This Scheduled Maintenance should be performed by an Authorized/Certified Champion Home Standby Service Dealer.

WARRANTY SCHEDULE

Years 1 and 2 – Limited comprehensive coverage on mileage, labor and parts

Years 3 through 10 – Limited comprehensive coverage on parts only

GUIDELINES:

- Warranty begins upon the successful activation of the unit.
- Unit should be Registered and Proof of Purchase and Maintenance must be available.
- Warranty is transferable between ownership of original installation site.
- Warranty only applies to permanently wired and mounted units.
- Any and all warranty repairs and/or concerns must be performed and/or addressed by an Authorized/Certified Champion Home Standby Service Dealer. Repairs or diagnostics performed by individuals other than Authorized/Certified Champion Home Standby Service Dealers not authorized in writing by Champion Power Equipment will not be covered.
- A Champion approved Transfer Switch is highly recommended to be used in conjunction with the generator set. The Champion Transfer Switch is covered under its own, separate warranty listed in the Transfer Switch Instruction Manual and is not covered under this warranty schedule.
- If a Non-Champion approved Transfer Switch is substituted for use and directly causes damage to the generator set, no warranty coverage shall apply.
- Steel enclosures are warranted against rusting for the first year of ownership only. Damage caused after receipt of generator is the responsibility of the owner and is not covered by this warranty. Nicks, scrapes, dents or scratches to the painted enclosure should be repaired promptly by the owner.
- All warranty expense allowances are subject to the conditions defined in Champion Power Equipment "Home Standby" Warranty Policy and Procedures Manual.

THIS WARRANTY SHALL NOT APPLY TO THE FOLLOWING:

Original installation or start-up costs

Champion Home Standby generators that utilize non-Champion Power Equipment replacement parts

Costs of normal maintenance (i.e. tune-ups, associated part(s), adjustments, loose/leaking clamps, installation and start-up)

Units sold, rated or used for "Prime Power", "Trailer Mounted" or "Rental Unit" applications

Damage to generator system (including transfer switch) caused by improper installation or costs necessary to correct installation

Units used for Prime Power in place of existing utility power (where utility power is present) or in place of utility power where utility power service does not normally exist. Prime power includes any application that does not use the utility grid for electric power (example: Solar power)

Fuel connections other than conventional utility company supplied natural gas systems or conventional LP vapor withdrawal systems

Any failure caused by contaminated fuels, oils or lack of proper fuels, oils or failure to perform scheduled maintenance and service the air filter

Steel enclosures that are rusting due to the improper installation, location in a harsh or saltwater environment or scratched where integrity of paint applied is compromised

Failures due, but not limited, to normal wear and tear, accident, misuse, abuse, negligence or improper installation. As with all mechanical devices, the Champion engines need periodic part(s) service and fluid replacement to perform as designed.

Failures caused by any external cause or act of God, such as collision, theft, vandalism, riot or wars, nuclear holocaust, fire, freezing, lightning, earthquake, windstorm, hail, volcanic eruption, water or flood, tornado or hurricane

Damage related to rodent and/or insect infestation

Covered warranty labor rates are based on normal working hours. Overtime, holiday, or emergency labor costs for repairs outside of normal business hours will be the responsibility of the customer

Any incidental, consequential or indirect damages caused by defects in materials or workmanship, or any delay in repair or replacement of the defective part(s)

Failure due to misapplication to provide sufficient cooling air and to regularly exercise the generator under load

Telephone, cellular phone, facsimile, internet access or other communication expenses

Living or travel expenses of person(s) performing service, except as specifically included within the terms of a specific unit warranty period

Expenses related to "customer instruction" or troubleshooting where no manufacturing defect is found

Rental equipment used while warranty repairs are being performed and/or overnight freight costs for replacement part(s)

Costs incurred for equipment used for removal and/or reinstallation of generator, (i.e.: cranes, hoists, lifts, etc.)

Planes, ferries, railroad, buses, helicopters, snowmobiles, snow-cats, off-road vehicles or any other mode of transport deemed abnormal

Starting batteries, fuses, light bulbs, engine fluids, and spark plugs

THIS WARRANTY AND THE ATTACHED U.S. EPA, CARB and/or ECCC EMISSION CONTROL SYSTEM WARRANTIES (WHEN APPLICABLE) ARE IN LIEU OF ALL OTHER WARRANTIES, EXPRESS OR IMPLIED, INCLUDING WARRANTIES OF MERCHANTABILITY OR FITNESS FOR A PARTICULAR PURPOSE.

Any implied warranties which are allowed by law, shall be limited in duration to the terms of the express warranty provided herein. Some states do not allow limitations on how long an implied warranty lasts, so the above limitation may not apply to purchaser/owner.

CHAMPION POWER EQUIPMENT'S ONLY LIABILITY SHALL BE THE REPAIR OR REPLACEMENT OF PART(S) AS STATED ABOVE. IN NO EVENT SHALL CHAMPION POWER EQUIPMENT BE LIABLE FOR ANY INCIDENTAL, OR CONSEQUENTIAL DAMAGES, EVEN IF SUCH DAMAGES ARE A DIRECT RESULT OF CHAMPION POWER EQUIPMENT'S NEGLIGENCE.

Some states do not allow the exclusion or limitation of incidental or consequential damages, so the above limitations may not apply to purchaser/owner. Purchaser/owner agrees to make no claims against Champion Power Equipment based on negligence. This warranty gives purchaser/owner specific legal rights. Purchaser/owner also may have other rights that vary from state to state.

To obtain warranty service or your nearest Champion Home Standby Dealer call Champion Power Equipment Customer Service toll free 1-877-338-0999, Monday - Friday from 8:30 AM - 5:00 PM (PST/PDT).

Contact Information

Address

Champion Power Equipment, Inc.

Customer Service

12039 Smith Avenue Santa

Fe Springs, CA 90670

www.championpowerequipment.com

Customer Service and Technical Support

Mon – Fri 8:30 AM – 5:00 PM (PST/PDT)

Toll Free: 1-877-338-0999

hsb@cpeauto.com

Fax No.: 1-562-236-9429

*Except as otherwise stipulated in any of the following enclosed Emission Control System Warranties (when applicable) for the Emission Control System: U.S. Environmental Protection Agency (EPA), California Air Resources Board (CARB) and/or Environment and Climate Change Canada (ECCC).