

#### IMPORTANT: RECEIVING INSTRUCTIONS

Visually inspect all components for shipping damage. If you find damage, notify the carrier at once. Shipping damage is NOT covered by warranty. The carrier is responsible for all repair or replacement costs resulting from damage in shipment.

Read this owners manual thoroughly before use and save.

Figure 1

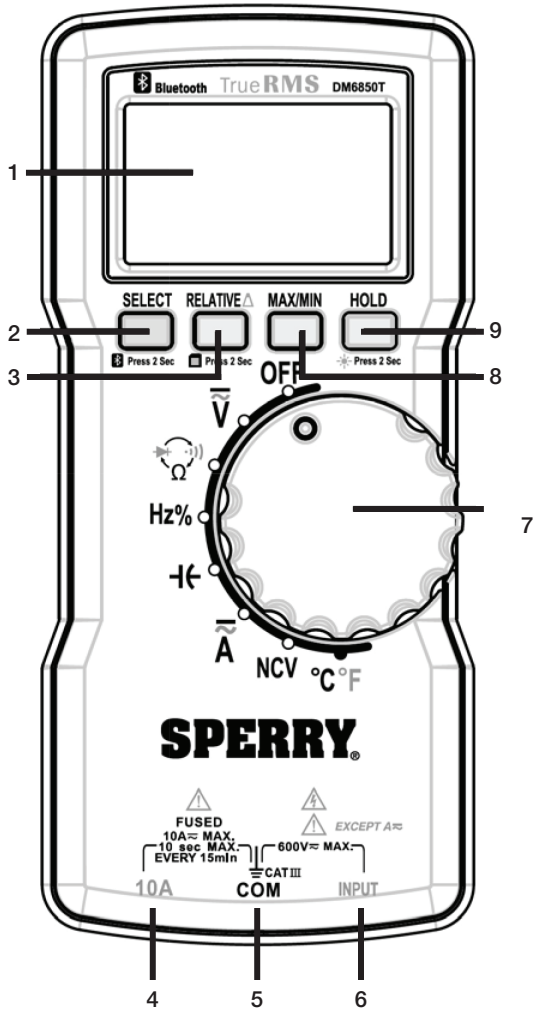

#### Rotary Switch

OFF	Power off	Capacitance
$\tilde{V}$	AC/DC Voltage Measurement	AC/DC Current Measurement
$\rightarrow \cdot \parallel \Omega$	Diode / Continuity / Resistance Measurement	NCV
Hz%	Frequency / Duty Cycle	°C/°F

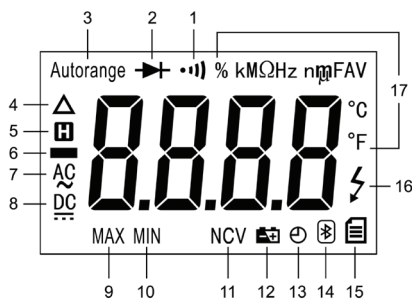

Figure 2

## 1.0 METER FUNCTIONS & DISPLAY SYMBOLS

### 1.1 FUNCTIONS (Figure 1)

- Display:** Backlit 3999 Count LCD screen
- SELECT Button:** Press to switch between:
  - DC voltage and AC voltage measurement functions
  - Resistance, diode, and continuity test functions
  - Frequency and Duty Cycle measurement functions
  - DC current and AC current measurement functions
  - Celsius temperature and Fahrenheit temperature measurement functions
 Hold for about 2 seconds to enable or disable Bluetooth communication
- RELATIVE Button:** Press to enter or exit Relative mode. Hold for about 2 seconds to start or stop recording readings in the memory of the meter.
- 10A Terminal:** Red test lead input jack for current measurements.
- COM Terminal:** Black test lead input jack common to all measurements.
- INPUT Terminal:** Red test lead input jack for all measurements except current measurements.
- Rotary Switch:** Turn to power the meter on and off and select the desired measurement function. To save battery power, turn to the "OFF" position when the meter is not in use. See "ROTARY SWITCH" section for function descriptions.
- MAX/MIN Button:** Press to enter or exit the Min/Max recording mode.
- HOLD Button:** Press to enter or exit the Data Hold mode. Hold for about 2 seconds to turn the backlight on or off.

### 1.1 METER FUNCTIONS

- Meter type:** Auto  
**Display Count:** 3999  
**Sampling Rate:** About 2 to 3 times/sec  
**Battery:** Requires 2 AAA batteries  
**Input impedance:** 10 Meg Ohm  
**AC Volt Ranges:** 4V, 40V, 400V, 600V, best accuracy (1.0%+5)  
**DC Volt Ranges:** 400mV, 4V, 40V, 400V, 600V, best accuracy (0.5%+5)  
**AC Amps:** 4A, 10A, best accuracy (1.0%+5)  
**DC Amps:** 4A, 10A, best accuracy (1.0%+5)  
**Resistance Ranges:** 400ohm, 4kohm, 40kohm, 400kohm, 4M ohm, and 40M ohm, best accuracy (0.8%+3)  
**Over Range Indication:** Displayed value > 3999 or the input measurement range, displays OL  
**Frequency Ranges:** 9.999Hz, 99.99Hz, 999.9Hz, 9.999kHz, 99.99kHz, 999.9kHz, 9.999MHz, best accuracy (1.0%+5)  
**Duty Cycle Range:** 5%-95%  
**Capacitance Ranges:** 9.999nF, 99.99nF, 999.9nF, 9.999uF, 99.99uF, 999.9uF, best accuracy (2.5%+5)  
**Temperature Ranges:** -4°F-1832°F (-20°- 1000°C)  
**Diode Test:** The approximate forward voltage drop of the diode will be displayed  
**Continuity Test:** Buzzer will sound if the resistance is < ~30Ω  
**Non-contact Volt Ranges:** 50 VAC, 120 VAC, 500 VAC  
**Polarity Indication:** "-" is displayed for negative polarity  
**Overload Protection:** 10A/600V Fast fuse  
**Agency Approvals:** ETL, CE (IEC/EN61010.; CAT III 600V, Pollution Degree 2)  
**Operating Temperature:** 32°F-104°F (0°C-40°C)  
**Relative Humidity:** < 75%  
**Storage Temperature:** 14°F-122°F (-10°C-50°C)  
**IP Degree:** IP20  
**Dimension:** 176mm x 81mm x 17mm  
**Weight:** Around 180g (without batteries)  
**Altitude:** Maximum 2000m  
**Warranty Info:** Limited lifetime warranty

## 1.2 DISPLAY SYMBOLS (Figure 2)

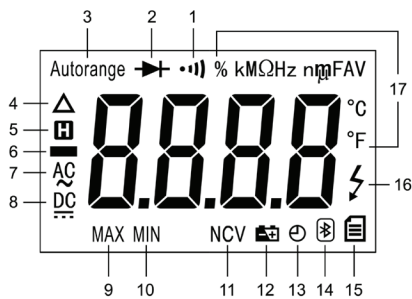

Figure 2

1. : Continuity test is selected
2. : Diode test is selected
3. **AURANGE**: Autorange mode is selected.
4.  $\Delta$ : Relative mode is active
5. **H**: Date Hold is enabled
6. **-**: Negative sign
7. **AC**: AC
8. **DC**: DC
9. **MAX**: Maximum reading is being displayed
10. **MIN**: Minimum reading is being displayed

11. **NCV**: Non-contact AC Voltage detection is selected
12. : The battery is low and must be replaced immediately
13. : Automatic power-off feature is enabled
14. : Bluetooth communication function is enabled
15. : Data recording is ongoing and the meter is saving readings in the memory of the meter
16. : Dangerous voltage is present, be cautious

## 17. Units

<b>mV, V</b>	Unit of voltage / mV: Millivolt; V: Volt $1V = 10^3mV$	<b>°C, °F</b>	Unit of Temperature °C: Celcius degree; °F: Farenheit degree
<b>A</b>	Unit of Current A: Ampere	Hz, kHz, MHz	Unit of Frequency / Hz: Hertz; kHz: kilohertz; MHz: Megahertz $1MHz = 10^3kHz = 10^6Hz$
<b>Ω, kΩ, MΩ</b>	Unit of Resistance / Ω: Ohm; kΩ: kilohm; MΩ: Megohm $1MΩ = 10^3kΩ = 10^6Ω$	%	Unit of duty cycle %: Percent
<b>nF, μF</b>	Unit of Capitance / nF: Nanofarad; μF: Microfarad $1μF = 10^3nF$		

## 2.0 READ FIRST: IMPORTANT SAFETY INFORMATION

Read this operators manual thoroughly before using this multimeter. This manual is intended to provide basic information regarding this meter and to describe common test procedures which can be made with this unit. Many types of appliance, machinery and other electrical circuit measurements are not addressed in this manual and should be handled by experienced service technicians.

Use extreme caution when using this multimeter. Improper use of this meter can result in severe damage, personal injury or death. Follow all instructions and suggestions in this operators manual as well as observing normal electrical safety precautions. Do not use this meter if you are unfamiliar with electrical circuits and proper test procedures.

### 2.1 SAFETY WARNINGS

- This instruction manual contains warnings and safety rules which must be observed by the user to ensure safe operation of the instrument and retain it in safe condition.
- Read through and understand the instructions contained in this manual before using the instrument.
- Keep the manual at hand to enable quick reference whenever necessary.
- The instrument is to be used only in its intended applications.
- Understand and follow all the safety instructions contained in the manual.
- It is essential that all safety instructions are adhered to.
- Failure to follow the safety instructions may cause injury, instrument damage

The symbol indicated on the instrument means that the user must refer to the related parts in the manual for safe operation of the instrument. It is essential to read the instructions wherever the symbol appears in the manual.

- DANGER** is reserved for conditions and actions that are likely to cause serious or fatal injury.
  - WARNING** is reserved for conditions and actions that can cause serious or fatal injury.
  - CAUTION** is reserved for conditions and actions that can cause injury or instrument damage.

### DANGER

- Never make measurement on a circuit in which voltage over 1000V exists.
- Do not exceed the CAT rating of the measuring device
- Do not attempt to make measurement in the presence of flammable gases.  
The use of the instrument may cause sparking, which can lead to an explosion.
- Never use the instrument if its surface or your hand is wet.
- Do not exceed the maximum allowable input of any measuring range.
- Never open the battery cover during a measurement.
- The instrument is to be used only in its intended applications or conditions.  
Use in other than as intended may cause instrument damage or serious personal injury.

## ⚠ WARNING

- Never attempt to make any measurement if any abnormal conditions are noted, such as broken case, cracked test leads and exposed metal part.
- Do not turn the function selector switch with plugged in test leads connected to the circuit under test.
- Do not install substitute parts or make any modification to the instrument. Return the instrument to your distributor for repair or recalibration.
- Do not try to replace the batteries if the surface of the instrument is wet.
- Always switch off the instrument before opening the battery compartment cover for battery replacement.











## ⚠ CAUTION

- Set the Function Switch to an appropriate position before starting measurement.
- Firmly insert the test leads.
- Disconnect the test leads from the instrument for current measurement.
- Do not expose the instrument to the direct sun, high temperature and humidity or dewfall.
- Be sure to power off the instrument after use. When the instrument will not be in use for a long period, place it in storage after removing the batteries.
- Use only a soft cloth dampened with water or neutral detergent for cleaning the meter. Do not use abrasives, solvents or harsh chemicals. Allow to dry thoroughly before use.

### Measurement categories (Over-voltage categories)

To ensure safe operation of measuring instruments, IEC61010 establishes safety standards for various electrical environments, specified as CAT I through CAT IV, and called measurement categories. Higher-numbered categories correspond to electrical environments with greater momentary energy, so a measuring instrument designed for CAT III environments can endure greater momentary energy than one designed for CAT II.

- **CAT I:** Secondary electrical circuits connected to an AC electrical outlet through a transformer or similar device.
- **CAT II:** Primary electrical circuits of equipment connected to an AC electrical outlet by a power cord.
- **CAT III:** Primary electrical circuits of the equipment connected directly to the distribution panel, and feeders from the distribution panel to outlets.
- **CAT IV:** The circuit from the service drop to the service entrance, and to the power meter and primary over current protection device (distribution panel).
- Avoid placing the meter in areas where vibration, dust or dirt is present. Do not store the meter in excessively hot, humid or damp places.
- This meter is a sensitive measuring device and should be treated with the same regard as other electrical and electronic devices.
- When the meter is not in use keep the meter turned off to keep the battery from discharging.
- When disconnecting the test leads from the unit, always grasp the leads where the input jacks meet the tester housing. Do not pull the leads out of the jacks by the insulated wire or transport the tester using the test leads as a carrying strap.

Symbols	
	Caution, risk of danger, refer to the operating manual before use
	Caution, risk of electric shock
	AC (Alternating Current)
	DC (Direct current)
	AC/DC Selectable (Alternating Current/Direct Current)
	Earth (ground) Terminal
	The equipment is protected throughout by double insulation or reinforced insulation
	Application around and removal from hazardous live conductors is permitted.
	Conforms to Standards of European Union
	Designates the product as recyclable electronic waste per WEEE Directive

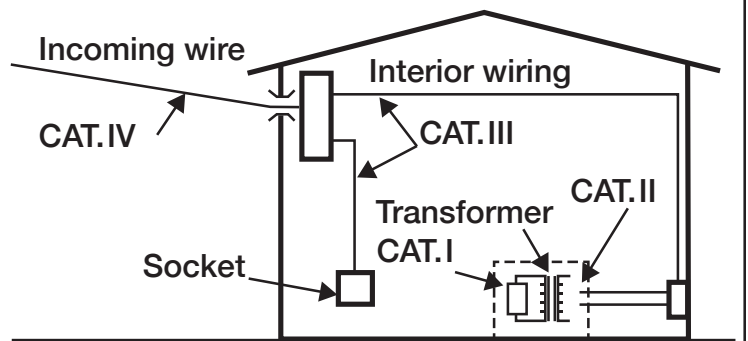

### 3. SPECIFICATION

#### 3.1 Measuring range & accuracy

(Accuracy guaranteed at 18°C - 28°C, humidity <75%)

#### AC CURRENT

RANGE	RESOLUTION	ACCURACY
4A	0.001A	±(1.5% + 5)
10A	0.01A	±(3.0% + 10)

- Frequency Response: 50Hz - 400Hz

#### DC CURRENT

RANGE	RESOLUTION	ACCURACY
4A	0.001A	±(1.2% + 5)
10A	0.01A	±(2.0% + 10)

#### AC VOLTAGE

RANGE	RESOLUTION	ACCURACY
4V	0.001V	±(1.0% + 5)
40V	0.01V	
400V	0.1V	
600V	1V	±(1.2% + 8)

- Main Display: Average Current

- Input Impedance: ≥10MΩ

- Frequency Response: 50Hz ~ 400Hz

#### DC VOLTAGE

RANGE	RESOLUTION	ACCURACY
400MV	0.1MV	±(0.8% + 5)
4V	0.001V	
40V	0.01V	
400V	0.1V	
600V	1V	±(1.0% + 5)

- Input Impedance: ≥10MΩ

#### RESISTANCE

RANGE	RESOLUTION	ACCURACY
400Ω	0.1Ω	±(1.2% + 5)
4KΩ	0.001KΩ	±(1.0% + 5)
40KΩ	0.01KΩ	
400KΩ	0.1KΩ	
4MΩ	0.001MΩ	±(1.2% + 5)
40MΩ	0.01MΩ	±(1.5% + 5)

#### CONTINUITY TEST

RANGE	RESOLUTION	ACCURACY
• )	0.1Ω	≤30Ω Buzzer beep
		30Ω-100Ω Buzzer may or may not beep
		≥100Ω No buzzer beep

- Open-circuit voltage: about 2.2V

#### FREQUENCY

RANGE	RESOLUTION	ACCURACY
99.99Hz	0.01Hz	±(10% + 5)
999.9Hz	0.1Hz	
9.999kHz	0.001kHz	
99.99kHz	0.01kHz	

#### DUTY CYCLE

RANGE	RESOLUTION	ACCURACY
5% TO 95%	0.1%	±(2.0% + 3)

#### CAPACITANCE

RANGE	RESOLUTION	ACCURACY
9.999nF	0.001nF	±(3.5% + 20)
99.99nF	0.01nF	±(2.5% + 20)
999.9nF	0.1nF	±(3.5% + 5)
9.999μF	0.001μF	±(5.0% + 5)
99.99μF	0.01μF	
999.9μF	0.1μF	

#### DIODE TEST

RANGE	RESOLUTION
	The approximate forward voltage drop of the diode will be displayed

- Open-circuit voltage: about 2.2V

#### TEMPERATURE °F

RANGE	RESOLUTION	ACCURACY
-4 TO 32	1°F	±(5.0% + 8)
32 TO 752	1°F	±(1.0% + 6)
752 to 1832	1°F	±(2.0% + 6)

#### TEMPERATURE °C

RANGE	RESOLUTION	ACCURACY
-20 TO 0	1°C	±(5.0% + 4)
0 TO 400	1°C	±(1.0% + 3)
-400 to 1000	1°C	±(2.0% + 3)

#### NON-CONTACT VOLTAGE (NCV) DETECTION

RANGE	DETECTION DISTANCE	APPLICATION
50V/50HZ	0 ~ 1"	Insulated Wire
120V/50HZ	0 ~ 2"	Outlet box w/ cover
500V/50HZ	0 ~ 12"	Outlet box w/o cover

## 4.0 FUNCTIONS



### 4.1 MAX/MIN BUTTON

1. Press **MAX/MIN** once to enter **MAX** mode. The symbol “**MAX**” will appear on the display and the display will show the maximum reading that the meter measures while in this mode.
2. Press **MAX/MIN** again to enter **MIN** mode. The symbol “**MIN**” will appear on the display and the display will show the minimum reading that the meter measures while in this mode.
3. To exit the **MAX/MIN** mode and erase stored readings, press and hold down the **MAX/MIN** button or turn the rotary switch.

### 4.2 HOLD BUTTON

1. Press **HOLD** once to enter data hold mode and freeze the displayed value. The symbol  will appear on the display.
2. Press **HOLD** again to exit data hold mode and resume normal measurement mode.

### 4.3 AUTO POWER OFF

1. The  symbol on the display indicates that the auto power-off feature is enabled. If you have not operated the meter for 15 minutes, the meter will turn off automatically and go into Sleep mode. It will beep 1 minute prior to turning off as a warning. To wake the meter from Sleep mode, turn the rotary switch or press a button.
2. To disable the automatic power-off function, hold down the “**SELECT**” button while turning the meter on. The  symbol will be absent from the display.

### 4.4 BACKLIT DISPLAY

1. Press and hold the **HOLD** button for at least 2 seconds to turn on the LCD display backlight.
2. Press and hold the **HOLD** button again for at least 2 seconds to turn off the LCD display backlight.

### 4.5 BLUETOOTH COMMUNICATION

1. Press and hold the “**SELECT**” button for at least 2 seconds to turn on Bluetooth communication. The  symbol will appear on the display. By using the Bluetooth communication function, this multimeter can communicate with Android or iOS based smart devices with Bluetooth connectivity.

*Note: When the Bluetooth communication function is enabled, the automatic power-off function is disabled automatically.*

2. Press and hold the “**SELECT**” button for at least 2 seconds to turn off Bluetooth communication. The  symbol will be absent from the display.

### 4.6 RELATIVE MEASUREMENT

1. The meter has a relative measurement feature that will display measured values as the difference between the measured value and the stored value.
2. While taking a measurement press the **RELATIVE** button to put the meter in the relative value measurement mode. The symbol  will appear on the display.
3. Pressing the **RELATIVE** button makes the current displayed value a reference value in memory. Subsequent measurements will be displayed as the measured value minus the stored reference value. The symbol will be displayed while the meter is in relative measurement mode.
4. The meter does not auto range during this function. The meter will display “OL” if the measurement exceeds the range.
5. Press the **RELATIVE** button again to resume normal operation.

### 4.7 DATALOGGING & RECORDING MEASUREMENTS

1. Hold the **RELATIVE** button for about 2 seconds to start or stop recording readings to the memory of the meter. The  symbol will appear on the display. See section 7.0 DATALOGGING & GET LOCAL for more information on the datalogging feature.

*Note: When the Bluetooth communication function is enabled, the automatic power-off function is disabled automatically.*

2. To stop datalogging, hold the **RELATIVE** button again for about 2 seconds.

## 5.0 DIAL SETTINGS

### 5.1 AC/DC VOLTAGE

#### AC Volts

To avoid personal injury or damage to the meter, do not attempt to measure voltages higher than 600V AC.

1. Insert the black (negative) test lead into the **COM** input terminal.
2. Insert the red (positive) test lead into the **INPUT** terminal to the right of the **COM** terminal.
3. Set the Rotary Switch to .
4. Press the “**SELECT**” button until AC is shown on the display.
5. Touch the test leads to the circuit under test. With AC voltage, the polarity of the test leads is not a factor.

*Note: It is best to touch one of the test leads to ground or neutral first and then touch the 2nd test lead to the hot wire.*

6. Read the value of the measurement displayed.
7. Typical AC Voltage measurements include wall outlets, appliance outlets, motors, light fixtures and switches.

## DC Volts

To avoid personal injury or damage to the Meter, do not attempt to measure voltages higher than 600 VDC.

1. Insert the black (negative) test lead into the **COM** input terminal.
2. Insert the red (positive) test lead into the **INPUT** terminal to the right of the **COM** terminal.
3. Set the Rotary Switch to  $\overline{\text{V}}$ .
4. Press the “**SELECT**” button until DC is shown on the display.
5. Touch the test leads to the circuit under test. Touch the black (common) test lead to the negative DC source (ground) first and red (positive) test lead to the “live” source second.
6. Read the value of the measurement displayed. If the leads are reversed a “-“ indicator will appear on the display.
7. Typical DC Voltage measurements include car batteries, automotive switches, motors, and household batteries.

## 5.2 AC/DC CURRENT

### AC Amps

If the fuse burns out during measurement, the meter may be damaged or personal injury may occur. To avoid possible damage to the meter or to the equipment under test, check the meter’s fuses before measuring current. Use the proper terminals, function, and range for the measurement. Never place the test leads in parallel with any circuit or component when the leads are plugged into the current terminals. Do not attempt to measure current exceeding 10A AC. If you are not sure if the current exceeds 10A do not attempt to measure current with this meter.

1. Insert the black (negative) test lead into the **COM** input terminal.
2. Insert the red (positive) test lead into the 10A terminal to the left of the **COM** terminal.
3. Set the Rotary Switch to  $\overline{\text{A}}$ .
4. Press the “**SELECT**” button until AC is shown on the display.
5. Turn off power to the circuit to be measured.
6. Open the circuit to be measured.
7. Touch the red test lead to one side of the break in the circuit and the black test lead to the other side of the break in the circuit.  
For AC Amp measurements the polarity of the leads does not matter.
8. Return power to the circuit.
9. Read the amps on the display.

*Note: When measuring AC Amps this meter displays the effective value of the sine wave (mean value response).*

*When the measured current is <5 amps continuous measurement is acceptable.*

*When the measured current is 5–10 amps do not exceed 10 seconds of continuous measurement. Wait 15 minutes before performing additional current measurements. Always turn off power to circuit and remove the leads from the circuit before removing and reinserting the leads into the meter’s input terminals. Once the measurement is complete, immediately remove the test leads from the circuit under test and remove the test leads from the input terminals of the meter.*

### DC Amps

If the fuse burns out during measurement, the meter may be damaged or personal injury may occur. To avoid possible damage to the meter or to the equipment under test, check the meter’s fuses before measuring current. Use the proper terminals, function, and range for the measurement. Never place the test leads in parallel with any circuit or component when the leads are plugged into the current terminals. Do not attempt to measure current exceeding 10Amps DC. If you are not sure if the current exceeds 10Amps do not attempt to measure current with this meter.

1. Insert the black test (negative) lead into the **COM** input terminal.
2. Insert the red (positive) test lead into the 10A terminal to the left of the **COM** terminal.
3. Set the Rotary Switch to  $\overline{\text{A}}$ .
4. Press the “**SELECT**” button until DC is shown on the display.
5. Turn off power to the circuit to be measured.
6. Open the circuit to be measured.
7. Touch the red test lead to the positive side of the break in the circuit and the black test lead to the negative side of the break in the circuit for DC Amp measurement.
8. Return power to the circuit.
9. Read the amps on the display.

*Note: When the measured current is <5 amps continuous measurement is acceptable. When the measured current is 5–10 amps do not exceed 10 seconds of continuous measurement. Wait 15 minutes before performing additional current measurements.*

*Always turn off power to circuit and remove the leads from the circuit before removing and reinserting the leads into the meter’s input terminals. Once the measurement is complete, immediately remove the test leads from the circuit under test and remove the test leads from the input terminals of the meter.*



## 5.3 RESISTANCE/CONTINUITY/DIODE

### Resistance

When measuring resistance always make sure the power to the circuit is off.

1. Insert the black (negative) test lead into the **COM** input terminal.
2. Insert the red (positive) test lead into the **INPUT** terminal to the right of the **COM** terminal.
3. Set the Rotary Switch to  $\Omega \rightarrow \bullet \bullet \bullet$ )
4. Press the “**SELECT**” button until \*insert resistance symbol\* is shown on the display.
5. Touch the test leads to the resistor or non-energized component to be measured.
6. Read the value of the measurement displayed. With resistance measurements, the polarity of the test leads is not a factor.
7. Typical resistance measurements include resistors, potentiometers, switches, extension cords and fuses.

*Note: For measurements > 1M $\Omega$ , the meter may take a few seconds to stabilize reading. This is normal for high resistance measurements. When the input is not connected, i.e. at open circuit, “OL” will be displayed as an overrange indication.*

### Continuity $\bullet \bullet \bullet$ )

To avoid damages to the Meter or to the devices under test, disconnect circuit power and discharge all the high-voltage capacitors before measuring resistance.

Do not input 60V DC or 30V AC to avoid personal harm. Do not use on energized circuits.

1. Insert the black (negative) test lead into the **COM** input terminal.
2. Insert the red (positive) test lead into the **INPUT** terminal to the right of the **COM** terminal.
3. Set the Rotary Switch to  $\Omega \rightarrow \bullet \bullet \bullet$ )
4. Press the “**SELECT**” button until  $\Omega$  is shown on the display.
5. Connect the test leads across with the object being measured.
6. The buzzer sounds continuously if the resistance of a circuit under test is <~30 $\Omega$ . It indicates the circuit connection is good.
7. The buzzer does not sound if the resistance of a circuit under test is >100 $\Omega$ . It indicates a possible broken circuit.
8. The buzzer may or may not sound if the resistance of a circuit under test is 30 $\Omega$  -100 $\Omega$ .
9. Read the resistance value on the display.
10. Typical continuity measurements include switches, extension cords and fuses.

*Note: Open circuit voltage is around 2.2V. When the input is not connected, i.e. at open circuit, “OL” will be displayed as an overrange indication.*

### Diode $\rightarrow \bullet$

1. Insert the black (negative) test lead into the COM input terminal.
2. Insert the red (positive) test lead into the INPUT terminal to the right of the COM terminal.
3. Set the Rotary Switch to  $\Omega \rightarrow \bullet \bullet \bullet$ ) symbol.
4. Press the “**SELECT**” button until  $\rightarrow \bullet$  is shown on the display.
5. For forward voltage drop readings on any semiconductor component, place the red test lead on the component’s anode and place the black test lead on the component’s cathode.
6. Read the resistance value on the display.

*Note: When measuring resistance, the circuit should be powered off and all capacitors should be completely discharged prior to testing. A more accurate measurement can be achieved by separating the component from the circuit being tested. When the test leads are not connected or are reversed, the display will show an over-range symbol “OL”.*

## 5.4 FREQUENCY/DUTY CYCLE

### Frequency Hz

1. Insert the black (negative) test lead into the COM input terminal.
2. Insert the red (positive) test lead into the INPUT terminal to the right of the COM terminal.
3. Set the Rotary Switch to Hz%
4. Press the “**SELECT**” button until Hz is shown on the display.
5. Place the red and black test leads at both the positive and negative points to be measured.
6. Read the value of the measurement displayed.

*Note: The voltage of the input signal should be between 1V rms and 20V rms. The higher the frequency of the signal, the higher the required input voltage. For measurements < 10Hz, the amplitude of the input signal must be more than 2V rms.*

### Duty Cycle %

1. Insert the black (negative) test lead into the COM input terminal.
2. Insert the red (positive) test lead into the INPUT terminal to the right of the COM terminal.
3. Set the Rotary Switch to Hz%
4. Press the “**SELECT**” button until % is shown on the display.
5. Place the red and black test leads at both the positive and negative points to be measured.
6. Read the value of the measurement displayed.

*Note: The voltage of the input signal should be between 4Vp-p and 10Vp-p. After removing the leads from the object being measure, the reading may still remain on the display. Pressing the **SELECT** button twice in a row will zero the display.*

## 5.5 CAPACITANCE $\text{--}\text{||}\text{--}$

When measuring resistance always make sure the power to the circuit is off.

1. Insert the black (negative) test lead into the COM input terminal.
2. Insert the red (positive) test lead into the INPUT terminal to the right of the COM terminal.
3. Set the Rotary Switch to \*insert capacitance symbol
4. Remove the capacitor from the circuit and ensure that it is properly discharged.
5. Place the red and black test leads at the capacitor terminal to be measured. It will take a few seconds for the capacitance to be displayed.

*Note: Because of the stray capacitance of the test leads and the input circuit of the meter, the display may show a reading other than zero before the test leads are connected to the capacitor to be tested. It is normal and this reading must be subtracted from any subsequent measurements. Make sure the capacitor to be tested has been discharged thoroughly before measurement. For measurements > 10  $\mu\text{F}$ , it may take up to 30 seconds for the meter to stabilize.*

## 5.6 TEMPERATURE $^{\circ}\text{C}$ $^{\circ}\text{F}$

1. Set the Rotary Switch to  $^{\circ}\text{C}/^{\circ}\text{F}$
2. Temperature can be displayed in both Celsius and Fahrenheit units.  
Press the “SELECT” key to switch the unit of temperature being displayed.
3. Insert the K-type Temperature Probe into the meter. The negative (-) side of the probe should be connected to the COM input and the positive (+) side of the probe should be connected to the INPUT terminal.
4. Contact the sensor (metal tip) of the K-type Temperature Probe to the object being tested.
5. The display will show the temperature measurement being taken.

*Note: Never touch the K-type Temperature Probe to an energized circuit.*

## 5.7 NON-CONTACT AC VOLTAGE DETECTION (NCV)

1. Remove the test leads
2. Rotate the dial to the NCV position
3. The meter will display “EF” when the NCV function is being used (Figure 3)
4. Move the top of the meter close to the object to be tested.
5. When the meter detects AC voltage, the built-in buzzer will beep and the display will indicate the intensity of the detected electric field.
6. The higher the intensity of the detected electric field, the larger the number of the bar graph segments (Figure 4 and 5), and the faster the beeping rate of the buzzer.



Figure 3

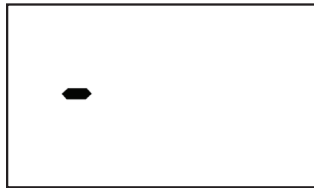

Figure 4

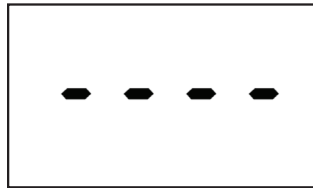
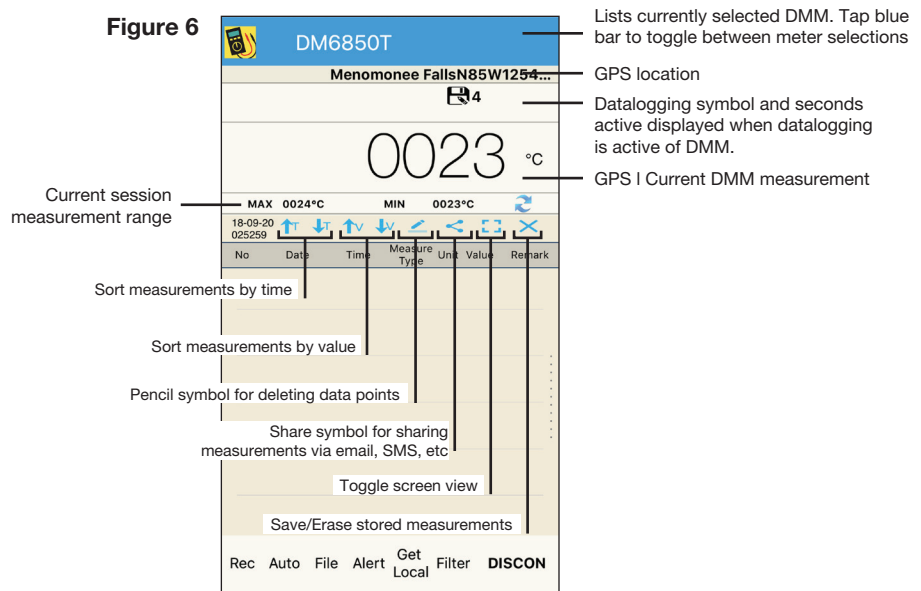

Figure 5

*Note: Test on a known live source before use. Even if the meter does not provide indication, potentially hazardous voltage could still be present (The meter will only detect voltages above 50VAC and only when conditions are correct). The meter can be affected by: Distance from voltage source, Condition of meter and batteries, Shielded wires, Metal enclosures, Insulation thickness, and Static charge among other things. The meter is sensitive to electrostatic fields. Occasionally a static charge may interfere with the meter detection and the meter may omit a tone momentarily.*

## 6.0 SMART DEVICE & APPLICATION

1. The Sperry DM6850T has the ability to be connected to your smart device via a Bluetooth connection.
2. While the connection is established the meter will continually transmit data to your smart device.
3. The measurement data will be shown in the “Measurement Display Area” of your smart device. (Figure 6)





## 6.1 DOWNLOAD THE APPLICATION



Figure 7

1. Using either App Store® for Apple® or Google Play™ store for Android™ platforms, search for “Sperry Smart Meter” (Figure 7) and select “GET” for Apple® or “Install” for Android™.
2. Once the application has finished installing the SperrySmartMeter app icon will appear on your device.

## 6.2 OPENING THE APPLICATION

1. Locate the Sperry SMARTmeter app.
2. Touch the icon to open.

## 6.3. CONNECTING YOUR SMART DEVICE

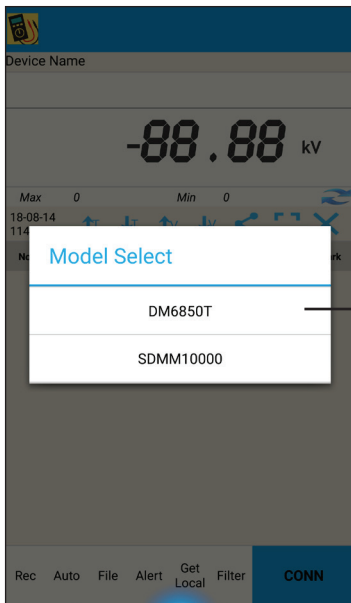

- 1 After the opening the app, select DM6850T

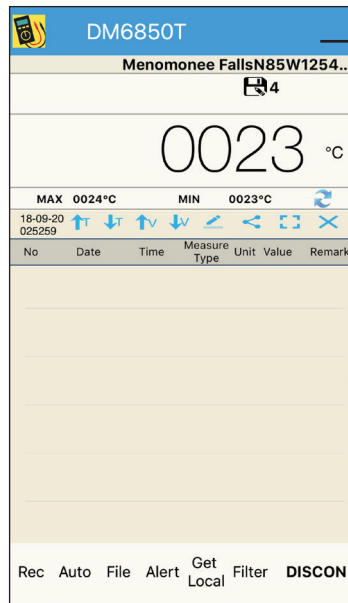

- 2 To toggle the meter selected when already in the app, tap the blue bar at the top

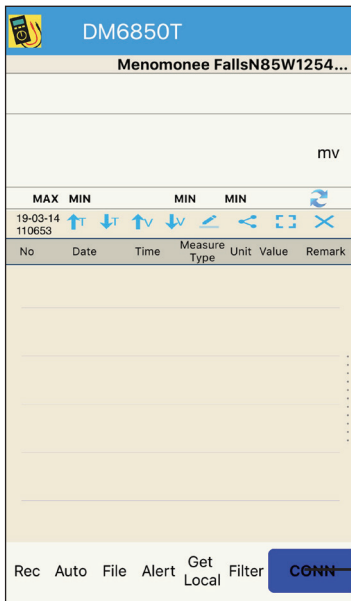

- 3 Press the blue flashing “CONN” button on the app, follow the on-screen directions.

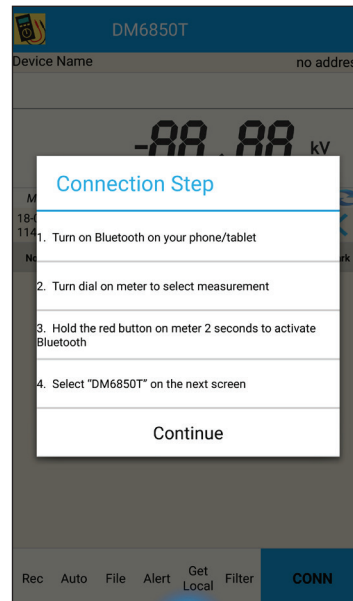

- 4 It may be necessary to press “scan” on your phone/tablet to complete step 4.

### 6.3. CONNECTING YOUR SMART DEVICE (CONT.)

1. Make sure that your smart device has Bluetooth enabled.
2. Open the SMARTmeter app on your smart device.
3. Tap the blue banner at the top of the screen on the App to change the meter you have selected. Switch to DM6850T
4. Touch the “CONN” button on the bottom right of the screen on your smart device and follow the instructions on the screen.
  - a. Turn on Bluetooth on your phone/tablet
  - b. Turn dial on meter to select measurement
  - c. Hold the red button on the meter for 2 seconds to activate Bluetooth.  
The meter will beep and the Bluetooth icon will appear on the screen when Bluetooth is activated.
  - d. Select “DM6850T” on the next screen
5. Tap “Continue” on your smart device.
6. Press the “Scan” button on your smart device.
7. A list of devices will appear. Select the device “DM6850T”
8. The devices are now connected. The Bluetooth symbol should appear on both the DM6850T and your smart device.

### 6.4 DATA LOGGING

Make sure that your smart device has Bluetooth enabled.

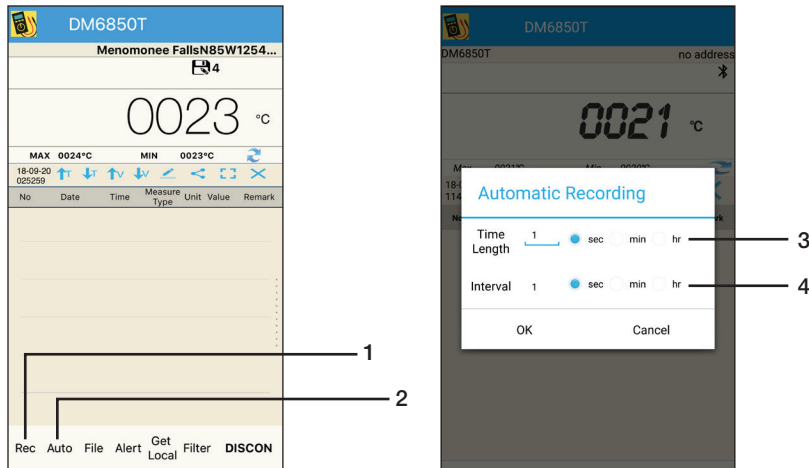

1. **Rec** – Record a single data point
2. **Auto** – Automatic recording
3. **\*Time Length** – Set the length of time to automatically record measurements
4. **\*Interval** – Set the time between each measurement which is automatically recorded

*Note: The interval should be the shorter than the time length.*

1. Data can be logged manually by pressing the “Record” button on your smart device for each measurement.
2. Data can be logged automatically by pressing the “Auto” button and inputting the recording length and interval.
3. The time base can be set to hours, minutes or seconds.
4. Once the length and interval have been entered press the “OK” button to begin recording.
5. After the “OK” button is pressed, your smart device will begin recording data points.  
As it is doing this you will immediately be prompted to name the file or accept the default file name.
6. Data points will continue to be recorded for the duration and interval specified.
7. If you wish to terminate the auto recording of data points simply press the “Stop” button on your smart device.
8. After the duration has elapsed your smart device will stop recording data points, but the readings will continue to be displayed. (See Data file management 6.7 for instructions on viewing saved data)

### 6.5 ALERT

- Set audible alerts if measurements exceed specified maximum/minimum values.
- Alert function only works when meter and phone/tablet are connected via Bluetooth.

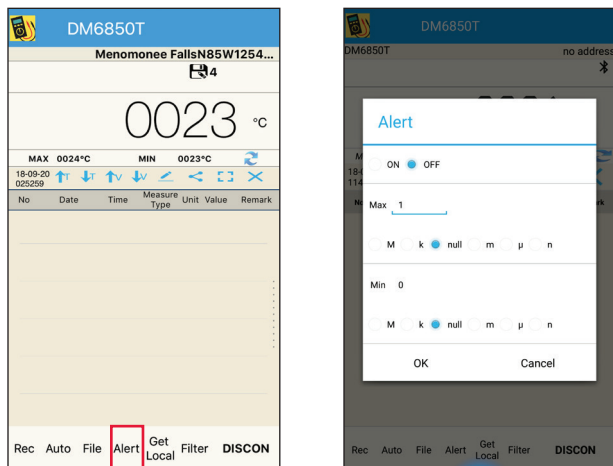

1. An alert can be set up to notify the user when readings are displayed that are outside of a set range.
2. To set up an alert press the “Alert” button and input the maximum value and minimum value.
3. The max / min values can be input in decimal form by selecting “Null” or by using the SI unit of measure prefixes n,  $\mu$ , m, k, M.
4. After entering the values, select “On” and press “OK”.
5. Your smart device will emit a beeping sound if the value displayed exceeds the range entered.
6. To deactivate the alert press the “Alert” button, select “Off” and press “OK”.

## 6.6 DATA FILE MANAGEMENT

- Open measurements previously saved to your phone/tablet.
- Save currently loaded measurements to your phone/tablet.

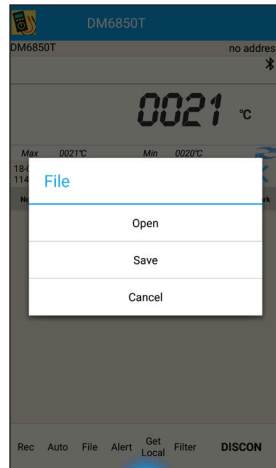
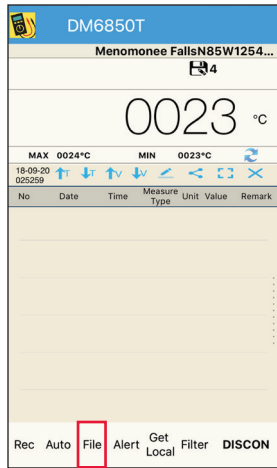

### 6.6.1 Rename & Save

1. Once data has been collected it can be given a unique file name by pressing the “File” button.
2. The screen that appears will allow you to rename the file or accept the default file name.
3. Name the file and press save.

### 6.6.2 Open

1. Previously saved data can be reopened by pressing the “File” button.
2. Press “Open” on the screen that appears.
3. A list of saved files will be displayed.
4. Press on the file that you wish to open.
5. The measurements recorded in this saved file will now be displayed.

### 6.6.3 Deleting saved files

1. To delete saved files press the “File” button.
2. Press “Open” on the screen that appears.
3. A list of saved files will be displayed.
4. Press “Edit.” (iOS only)
5. Select the file that you wish to remove and press delete.
6. When finished removing files press “Over”.
7. Select “File List” to return to the previous screen.

### 6.6.4 Renaming Saved Files

1. Open the file that you wish to rename.
2. Press “File” and then “Save”.
3. The screen that appears will allow you to rename the file.
4. Name the file and press save.
5. A copy of the file has been saved with the new name.
6. If you no longer require the file with the original name follow the instruction above in section 6.7.3

### 6.6.5 Data/Chart View

1. Open the file that you wish to rename.
2. Press “File” and then “Save”.

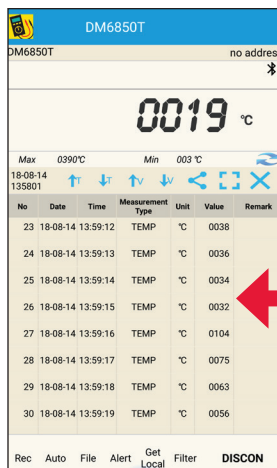

Swipe left/right on screen to toggle between data and chart views for measurements



### 6.6.6 Deleting data points

1. Individual data points can be deleted.
2. Press the \*pencil\* symbol. (iOS only)
3. Select the data point that you wish to remove and press delete.
4. Press the check mark symbol once you are finished deleting data points.

### 6.6.7 Deleting the data table

1. The entire data table can be deleted.
2. Press the X.
4. The data table will be cleared.
5. If the data was previously saved it can be reopened.

## 6.6.8 Remarks

1. To add a comment about an individual data point press the blank space in the remark column.
2. The screen that appears will allow you to enter a comment.
3. Enter the comment and press “Back” to return to the previous screen.
4. Your comment will now be displayed in the “Remark” column.

## 6.6.9 Filter

- Set filters for captured data if measurements exceed specified maximum/minimum values.
- Filter alert function only works when meter and phone/tablet are connected via Bluetooth.

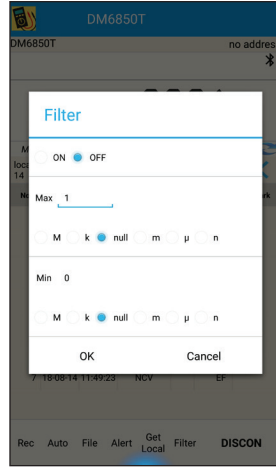
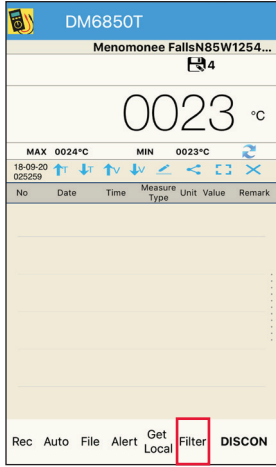

1. A filter can be set up to only display readings that are inside a set range.
2. To set up a filter press the “Filter” button and input the maximum value and minimum value.
3. The max / min values can be input in decimal form by selecting “Null” or by using the SI unit of measure prefixes n, μ, m, k, M.
4. After entering the values, select “On” and press “OK”.
5. Your smart device will only display values inside the range entered.
6. To deactivate the filter press the “Filter” button, select “Off” and press “OK”.

## 6.7 DATA FILE SHARING

### 6.7.1 Sharing as a Table

1. Open a file or record data.
2. Press the \*share\* symbol.
3. You will be prompted to save the file. (iOS only)
4. If you wish to change the name enter the new name and press “Save.” (iOS only)
5. If you wish to continue sharing with the default or previously assigned name just press “Save.” (iOS only)
6. You will be given the option to share “Data”, “Picture”, or “Cancel”.
7. Selecting “Data” will allow you to share the data via a number of applications.
8. The data will be shared in .xml format.

### 6.7.2 Sharing as an Image

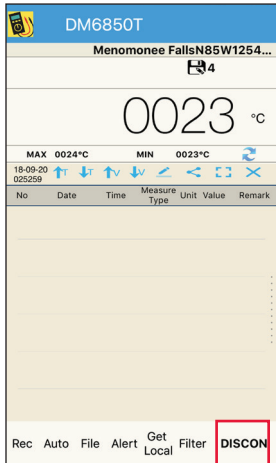

1. Open a file or record data.
2. Press the share symbol .
3. You will be prompted to save the file. (iOS only)
4. If you wish to change the name enter the new name and press “Save.” (iOS only)
5. If you wish to continue sharing with the default or previously assigned name just press “Save.” (iOS only)
6. You will be given the option to share “Data”, “Picture”, or “Cancel”.
7. Selecting “Picture” will allow you to share the data chart via a number of applications.

## 6.8 DISCONNECT



Press the “DISCON” button to disconnect Bluetooth connection between the DMM and phone/tablet

## 7.0 DATALOGGING & GET LOCAL

1. To begin datalogging, hold the RELATIVE button on the DM6850T for about 2 seconds.
2. The meter will beep and a  symbol will appear on the display when datalogging is active.
3. If datalogging is active while the DM6850T is connected to the SmartMeter App, the  symbol will also be displayed on the app along with a timer showing how long datalogging has been active.
3. Begin measurements. Measurements are stored at a rate of 1/second for a maximum of 36 hours.
  - a. Stored data is saved until datalogging is deactivated then activated again or if the DM6850T is turned off and back on. At that point, any data previously stored will be deleted and overwritten the next time datalogging is activated.
  - b. Stored data is overwritten if datalogging is deactivated then activated again or if the DM6850T is turned off.
  - c. Stored data is deleted if datalogging is deactivated then activated again or if the DM6850T is turned off.
4. To stop datalogging, hold the RELATIVE button again for about 2 seconds
5. To download data stored on the meter, connect the meter to the Sperry SmartMeter app on your phone or tablet (see section 6.0 SMART DEVICE & APPLICATIONS for instructions).
6. In the SmartMeter app, go to the main screen. Select Get Local. Datalogged data stored on the DM6850T will be displayed in the app. This data can be managed and/or shared (See Section 6.6 Data File Management and Section 6.7 Data File Sharing above).

### GET LOCAL

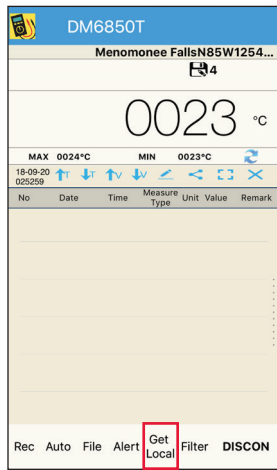

Download datalogged measurements captured on DMM to phone/tablet

*Note: Date and time will reflect when the data is downloaded, not when the data is measured/captured*

## 8.0 BATTERY REPLACEMENT

To avoid false readings, which could lead to possible electric shock or personal injury, replace the battery as soon as the battery indicator  appears.

1. Disconnect the connection between the test leads and the circuit under test, and remove the test leads from the input terminals of the meter.
2. Turn the Meter power off.
4. Remove the screw from the battery cover on the back of the meter. Slide the battery cover off.
5. Replace the old batteries with 2 fresh AAA batteries.

*Note: Do not use rechargeable batteries in this unit.*

6. Carefully slide on the battery cover and tighten the screw.  
Do not overtighten the screw as this may strip the threads in the meter housing.

## 9.0 FUSE REPLACEMENT

To avoid personal injury or damage to the Meter, use specified fuses **ONLY** in accordance with the following procedure.

To replace the Meter's fuse:

1. Turn the Meter off and remove test leads from the input terminals.
2. Remove the 5 screws from the case bottom, and separate the case top from the case bottom.
3. Remove the fuse by gently prying one end loose, then remove the fuse from its bracket.
4. **ONLY** install replacement fuses of the identical type and specification as follows and make sure the fuse is inserted firmly into the fuse holder brackets.

**Fuse 1:** 12A/600V, fast type, 6.35mm x 32mm.

5. Rejoin the case bottom and case top, and reinstall the 5 screws. Be careful not to overtighten the screws.  
Replacement of the fuse is seldom required. A burned fuse suggests improper operating procedures.

## 10.0 GENERAL SERVICE

- Periodically wipe the case with a damp cloth and mild detergent. Do not use abrasives or solvents.
- To clean the terminals use a cotton swab and detergent, as dirt and moisture in the terminals can affect readings.
- Turn the Meter power off when it is not in use.
- Take out the battery when it is not used for a long time.
- Do not use or store the Meter in a place of humidity, high temperature.

## **SPERRY INSTRUMENTS LIMITED LIFETIME WARRANTY**

Subject to the exclusions and limitations detailed below, Sperry Instruments provides a limited lifetime warranty on products of its manufacture will be free from defects in materials and workmanship under normal use and service.

### **Limited**

Limited means that Sperry Instruments warrants to the original purchasers of products from Sperry Instruments authorized distributors at the time of shipment such products shall be free of defects in material and workmanship while the tool is used under normal working conditions. Standard wear and tear, dulling over time, overloading, misuse, and acts of God are not covered under warranty. This warranty does not cover batteries, fuses, or test leads.

When a warranty claim arises, the purchaser must contact Sperry Instruments. If the defect comes under the terms of this limited warranty, Sperry Instruments will arrange, at its sole discretion, one of the following options:

- Product will be replaced

The purchaser is solely responsible for determining the suitability of Sperry products for the purchaser's use or resale, or for incorporating them into articles or using them in the purchaser's applications. The distributor is authorized to extend the foregoing limited warranty to its original purchasers in connection with the sales of Sperry products, provided that such products shall not have been altered by the distributor. The distributor shall be fully responsible for any warranties the distributor makes to its purchasers which are broader or more extensive than Sperry's limited warranty.

### **Lifetime Warranty**

Warranty Limitation: The forgoing warranties are exclusive and are in lieu of all other express and implied warranties whatsoever, including but not limited to implied warranties of merchantability and fitness for a particular purpose. The foregoing warranties do not cover ordinary wear and tear, abuse, misuse, overloading, alterations, products which have not been installed, operated or maintained in accordance with Sperry's written instructions. Test leads, fuses, batteries and calibration are not covered under any implied warranty. "Lifetime" of products that are no longer offered by Sperry will be either repaired or replaced with an item of Sperry Instruments choice of similar value. Lifetime is defined as 5 years after Sperry discontinued manufacturing the product, but the warranty period shall be at least ten years from date of purchase. Original proof of purchase is required to establish original ownership of product.

No warranty will be honored unless an invoice or other proof of purchase date is provided to Sperry Instruments. Hand written receipts or invoices will not be honored.

©2019 ECM Industries, All rights reserved.

- See more at: <http://www.sperryinstruments.com/en/resources/warranty-page>

**SPERRY®  
INSTRUMENTS**

Sperry Instruments  
800-645-5398  
Menomonee Falls, WI 53051  
[sperryinstruments.com](http://sperryinstruments.com)

SPR\_TL\_086\_0319