

INSTRUCTION MANUAL

MODEL #

SERIAL # _____





STATIONARY AIR COMPRESSOR MANUAL

INSTALLATION ~ OPERATION ~ MAINTENANCE

WARNING
**COMPRESSOR DISCHARGE AIR MAY CONTAIN HYDROCARBON
 AND OTHER CONTAMINANTS; THEREFORE, DO NOT USE
 DISCHARGE AIR FOR BREATHING.**

RECORD OF PERTINENT INFORMATION

Make a permanent record of the model and serial number of your new air compressor here. You'll save time and expense by including this reference information when requesting service or replacement parts.

Place & Date of Purchase		Volts	
Model		Hz	
Serial #		HP	

With shut-off valve to outside line(s) closed and tank pressure at 0 PSI, record the amount of time it takes to build tank pressure in the space provided below. Periodically test your compressor against this pump-up time to determine if it is operating correctly. If time test is considerably off, contact your local ROLAIR representative to arrange service.

From 0 to ____ PSI			From 0 to ____ PSI		
Date	Min.	Sec.	Date	Min.	Sec.

RECEIVING INSTRUCTIONS

CONGRATULATIONS ON THE PURCHASE OF YOUR NEW ROLAIR COMPRESSOR!

Immediately upon receipt of your air compressor and prior to completely uncrating, the following steps should be taken:

- Step 1) Remove box and inspect compressor for damage that may have occurred during shipment. If any damage is found, demand an inspection from the carrier. Ask the carrier how to file a claim for shipping damages. Freight damage is not covered by ROLAIR warranty.
- Step 2) Insure that adequate lifting equipment is available for moving the air compressor.
- Step 3) Record the model number and serial number from the unit nameplate on the front of your owner's manual. Space is also provided for pump-up time test to be performed and recorded upon initial start-up of air compressor.





⚠ WARNING







The engine exhaust from this product contains chemicals known to the State of California to cause cancer, birth defects or other reproductive harm.

⚠ WARNING







Do not start, operate or service machine until you read and understand operator's manual. Failure to do so could result in serious injury.

SAFETY WARNINGS

READ AND UNDERSTAND ALL SAFETY WARNINGS BEFORE USING AIR COMPRESSOR

Hazard Level	Potential of Hazard	How to Avoid Hazard
 Risk of Asphyxiation	Serious injury or death may occur from inhaling compressed air. The air stream may contain carbon monoxide, toxic vapors, or solid particles.	Never inhale compressed air directly from the pump, receiver, or from a breathing device connected to the air compressor.
	Sprayed materials such as paint, stucco, insecticides, solvents, etc. contain harmful vapors and poisons that may cause serious injury or death if inhaled.	Operate compressor only in a well-ventilated area. Use a respirator device and follow the manufacturer's recommendations for their spray equipment. Keep compressor at least 25 feet away from spray equipment.
	Serious injury or death may occur if the exhaust from gas-powered small engines is inhaled. Engine exhaust fumes contain poisonous, carbon monoxide which is odorless and colorless.	Operate gas-powered compressors only in a well-ventilated area. Avoid inhaling engine exhaust fumes, and never run a small gas-powered engine in a closed building or confined area without adequate ventilation.
 Risk of Bursting	Serious injury or death may occur from an air tank explosion if the air tanks are not properly maintained or if modifications, alterations or repairs are attempted to the air receivers.	Drain air tanks daily or after each use. Never drill into, weld, patch or modify the air tanks. If a leak develops, replace the tank immediately or replace the entire compressor.
	Serious injury or death may occur if modifications are made to the pilot unloader valve, pressure switch, safety relief valve or other components that control the tank pressure.	Never make adjustments to the components that control tank pressure. Do not make alterations to the factory operating pressure settings. Check operation of the safety valve on a regular basis and never operate without a factory approved safety valve.
	Serious injury may occur if accessories or attachments are operated above the manufacturer's recommended pressure ratings, causing them to explode or fly apart.	Do not use air tools or attachments before reading the owner's manual to determine the maximum pressure recommendations. Never exceed the manufacturer's maximum allowable pressure ratings. Do not use compressor to inflate small low pressure objects such as toys.
  Risk of Electrocution or Electrical Shock	Serious injury or death could occur if the air compressor is not properly grounded.	Always plug compressor into a properly grounded outlet which provides correct voltage, proper grounding and adequate fuse protection.
	Electrical shock may occur if compressor is not properly operated.	Never operate air compressor in wet conditions or outdoors when it's raining. Do not allow electric cords to lay in water. Do not operate with damaged power cord or with protective electrical covers removed. Do not touch plug with wet hands. Do not pull on electric cord to disconnect from the outlet.
	Serious injury or death may occur if electrical repairs are attempted by unqualified personnel.	Any electrical repairs or wiring performed on this compressor should only be performed by authorized service personnel in accordance with the National and Local Electric Codes.
  Risk of Explosion or Fire	Serious injury or death may result from normal electrical sparks that occur within the motor and/or pressure switch.	Always operate compressor in a well-ventilated area free of combustible materials, gasoline, flammable solvents or vapors. Always locate compressor at least 20 feet away from work area if spraying flammable materials.
	Serious injury may occur if a fire is caused by overheating due to inadequate ventilation or restrictions to any of the compressors ventilation openings.	Never place objects against or on top of an air compressor. Always operate air compressor at least 18" away from any wall or obstruction. Always operate in a clean, dry and well-ventilated area.
	Serious injury or death may occur from a fire or explosion if spilled gas or vapors come in contact with hot engine parts and ignite.	Never attempt to fill the gas tank while the engine is hot or running. Add fuel outdoors in a well-ventilated area. Do not fill gas tank near lit cigarettes or near other sources of ignition.

SAFETY WARNINGS (con't)

 Warning Risk from Moving Parts	<p>Serious injury may occur from moving parts such as belts, pulleys, flywheels or fans if they came in contact with you or your clothing.</p>	<p>Never operate the air compressor without protective belt guards installed. Replace damaged protective covers or guards immediately.</p>
	<p>An electric air compressor with automatic controls can restart at any time and cause bodily injury when least expected.</p>	<p>Always unplug air compressor and drain air tanks completely before attempting any repairs or performing maintenance. Never allow children or adolescents to operate air compressor.</p>
	<p>Serious injury may occur if repairs are attempted with damaged, missing or removed protective guards, shrouds or missing covers.</p>	<p>All repairs to the air compressor should be made only by authorized or trained service personnel.</p>
 Caution Risk of Burn	<p>Serious burn injuries could occur from touching exposed metal parts such as the compressor head, copper/braided discharge lines and engine exhaust muffler during operation, and even after compressor is shut down for sometime.</p>	<p>Never touch any of the exposed metal parts during operation and for an extended period of time after the air compressor has shut down. Do not attempt maintenance on the unit until it has been allowed to completely cool.</p>
 Warning Risk of Injury from Lifting	<p>Serious injury can result from attempting to lift an object that is too heavy.</p>	<p>Always obtain assistance from others before attempting to lift any object that is too heavy for one person.</p>
 Caution Flying Objects	<p>Serious injury may occur from loose debris being propelled at high speeds from the compressed air stream.</p>	<p>Always wear OSHA required "287" safety glasses to protect the eyes during operation of the air compressor. Never point the air stream or tools at any point of your body, other people or animals. Always turn off the air compressor and drain tank pressure completely before attempting maintenance or attaching air tools.</p>
 Warning Risk of Unsafe Operation	<p>Serious injury or death may occur to you or others if air compressor is used in an <u>unsafe</u> manner.</p>	<p>Review and understand all instructions and warnings in your owner's manual. Know how to stop the air compressor. Do not operate until you are thoroughly familiar with all of the controls. Do not operate the compressor if fatigued or under the influence of alcohol or drugs. Stay alert while operating the compressor and pay close attention to the task at hand.</p>
 Caution Risk of Damage to Air Compressor or Property	<p>Failure to transport or operate the air compressor properly may result in major repair expenses. Oil leaks will damage carpets, painted surfaces, flooring and other items.</p>	<p>Check oil levels daily and maintain proper oil levels. Always run compressor in a level, secure position that keeps it from tipping or falling during use. Do not operate without an air filter or in a corrosive environment. Always transport in a level position and use protective mats to keep truck beds clean, etc. Check drain bolts regularly and do not overfill machinery with oil.</p>

IMPORTANT

Please note that this product may not be equipped with a spark arresting muffler. If the compressor is operated around flammable materials or agricultural crops, brush, forests, and grasslands an approved spark arrestor must be installed, maintained and in good working order. An approved spark arrestor is legally required in the State of California under sections 4442 and 4443 of the California Public Resources Code Statute section 130050.

This product contains chemicals, including lead, known to the state of California to cause cancer, birth defects, and other reproductive harm. Always wash hands after handling this product.

Periodic inspection of in-service pressure-retaining items is mandated in your jurisdiction. In addition to performing these inspections, your jurisdiction may require or permit insurance companies to provide the mandated inspection service for their insured. Information for your jurisdiction can be found on the National Board of Boiler and Pressure Vessel Inspectors website by typing www.nationalboard.org/NationalBoard/Members/ in your web browser.

INSTALLATION

LOCATION:

- Locate the compressor in a cool, dry, clean and well ventilated area with a temperature range between 35° and 105° F. **WARNING!** Under no circumstances should the air compressor be installed in an area that may be exposed to a dirty, corrosive atmosphere, toxic vapors or volatile fumes. Do not store toxic, volatile or corrosive agents near the compressor.
- The intake filter may be remotely located. Enlarge size of intake piping by 1/4" in size for each 10 feet of length.
- Install so that the flywheel/belt guard is at least 18" from an adjacent wall. Allow space on all sides for air circulation and ease of maintenance.
- Make sure the compressor tank is mounted level on a solid foundation using vibration dampening pads made of felt/rubber. If vibration pads cannot be located, the skid on which the compressor is shipped may be left on and used as a mounting base. Solid shims may be used to level unit before bolting or lagging unit to prevent movement.

NOTE: Contact your local ROLAIR representative for information on level-rite mounting pads or if excessive vibration or movement is noticed upon initial test run.

When hard-mounting a gas-powered air compressor on a trailer or a truck bed, leave one of the four mounting bolts looser than the others (slightly beyond hand-tight) to help minimize vibration and improve the overall performance and life of the unit.

ELECTRICAL CONNECTIONS AND MOTOR WIRING:

Most stationary ROLAIR compressors are shipped without a power cord. All power cords attached to this machine must be properly grounded and installed by a qualified electrician with knowledge of the National Electrical Code (N.E.C.), OSHA Code and/or any local/state/provincial codes having precedence. Failure to abide by applicable electrical codes may result in personal injury or property damage.

Check the electrical supply for voltage, phase and frequency to see that they match the nameplate stampings on the motor, magnetic starter, solenoids and other controls. Use electrical wires of adequate size to carry the full load current of the motor without excessive voltage drop.

The motor must always be protected by a starter with properly sized thermal overload(s). The starter should protect the motor from overheating and burn-out due to an overload, low voltage or single phasing of a 3-phase circuit. Failure to install the proper starter and overloads will void the motor manufacturer's warranty. Follow the National Electric Code or local electric code in providing wiring, fusing and disconnect switches.

After the wiring is completed, momentarily start the motor to make certain that the compressor flywheel rotates in the same direction as indicated by the direction arrow on the compressor flywheel.

NOTE: An easy way to check for proper rotation is to place a piece of paper on the outside of the belt guard cover while the machine is running. If the piece of paper is blown away, the rotation is incorrect. Consult a qualified electrician to correct the rotation. Improper rotation will lead to overheating and oil blowing out of the crankcase breather.

PIPING FIT-UP:

Always position air compressor to avoid an excessive amount of tension between the external air lines and connection at the air tank. The piping should be lined up without having to spring or twist it into position. Adequate expansion loops or bends should be installed to prevent undue stresses at the compressor resulting from the changes between hot and cold conditions. Pipe supports should be mounted independently of the compressor and anchored as necessary to limit vibration and prevent expansion strains.

*Never join pipes or fittings with lead-tin soldering. Welded or threaded steel pipes and cast-iron fittings, designed for the pressures and temperatures, are recommended. Never use PVC or plastic pipe.

Air CFM	Pipe sizes for compressed air lines							
	Length of Pipe Lines in Feet							
	25	50	75	100	150	200	250	300
1-5	1/2	1/2	1/2	1/2	1/2	1/2	1/2	1/2
10	1/2	1/2	1/2	3/4	3/4	3/4	3/4	3/4
15	1/2	3/4	3/4	3/4	3/4	3/4	3/4	3/4
25	3/4	3/4	3/4	3/4	3/4	1	1	1
30	3/4	3/4	3/4	3/4	1	1	1	1
35	3/4	3/4	1	1	1	1	1	1
40	3/4	1	1	1	1	1	1	1
60-70	1	1	1	1	1-1/4	1-1/4	1-1/4	1-1/4
80-100	1-1/4	1-1/4	1-1/4	1-1/4	1-1/2	1-1/2	1-1/2	1-1/2

Check all piping and fittings regularly to avoid leaks in the system.

INSTALLATION

(con't)

PIPING:

The compressed air distribution system should be of sufficient pipe size to keep the pressure drop between the supply and point of use to a minimum. All piping should be sloped to an accessible drain-point. Outlets should be taken from top of mainline so that moisture will not enter the outlet.

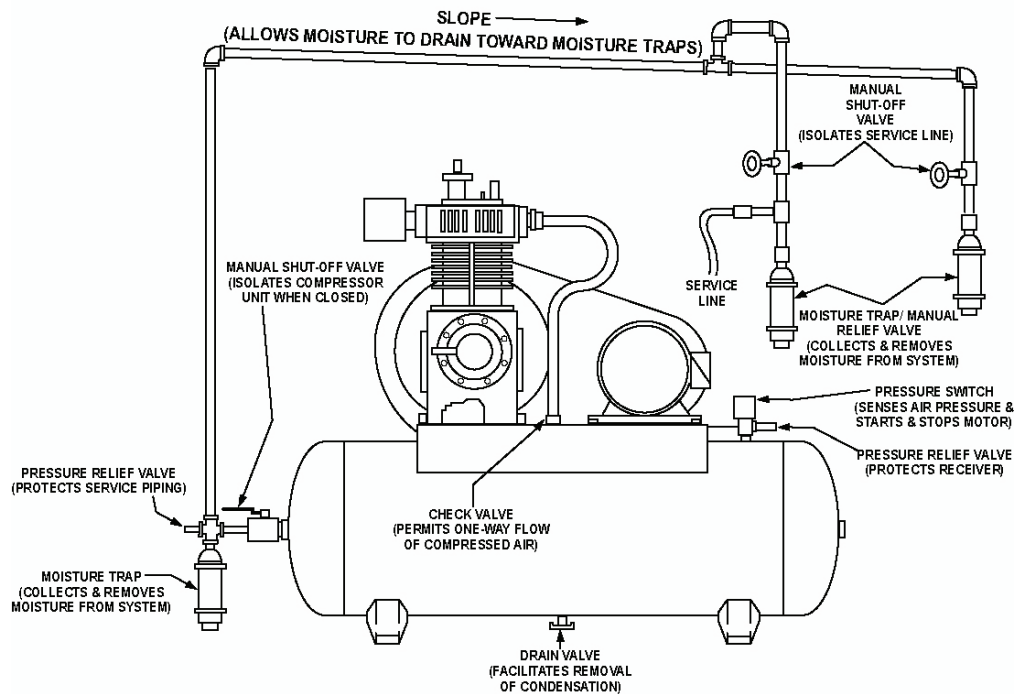

OPERATION

LUBRICATION:

Prior to daily operation, make a habit of checking the oil level in your compressor pump. A sight gauge on the outside of the pump's crankcase is provided to make the job easier. Always maintain the oil level to read 2/3 full on the sight gauge. Oil levels over this amount will result in oil blowing past the rings or out of the crankcase breather. Lower amounts of oil will result in insufficient lubrication of moving parts.

Reciprocating compressors will consume a certain amount of oil under normal operation. If you are concerned about your oil consumption, monitor and record oil consumption daily and consult your local dealer. When filling your crankcase with oil, be sure to use a single viscosity, non-detergent oil. **DO NOT USE A DETERGENT OIL!!**

Oil Capacity (oz.)	
K8	12
K11	17
K12	15
K17	34
K18	34
K22	61
K23	61
K24	61
K25	61
K28	61
K30	47
K35	47
K50	59
K60	98
K70	98
K100	127

Check the oil before starting.

Prior to shipping, complete units are filled with oil and tested. The oil should be drained and replaced after an initial break-in period of 50 hours.

NOTE: Bare pumps are shipped without oil. See reference charts for oil type and capacity.

Whether you have purchased a complete unit or bare pump, check the oil level and correct if needed before starting each day.

Important: Do not over-fill your pump. It will cause harm.

After break-in period, use a single grade, non-detergent motor oil with foam, rust and oxidation inhibitors. For maximum performance and service life, we recommend using ROLAIR Premium Quality compressor oil. (See your oil distributor or representative for compressor oil.)

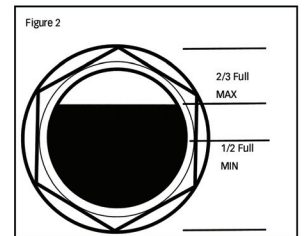

Proper Oil Level:

Ambient Temperature	Viscosity @100 °F SSU	ISO Viscosity CS+	SAE No.
0° - 40°	250-350	46-68	20
40° - 80°	450-550	100	30
80° - 120°	650-750	150	40
Under 0°	Consult Factory		
Over 120°	Consult Factory		

DO NOT USE DETERGENT OIL!

See chart for oil recommendation in varying temperature conditions.

SYSTEM COMPONENTS

Efficiency and safety are the primary concerns when selecting components for compressed air systems. Products of inferior quality can not only hinder the performance of the unit, but could cause system failures or bodily harm. Select only top quality components for your system. Call your local ROLAIR distributor for quality parts and professional advice.

DRIVE PULLEYS: Drive pulleys must be properly aligned and drive belt tension set to specifications. Improper pulley alignment and belt tension can cause motor overloading, excessive vibration and premature belt and/or bearing failure.

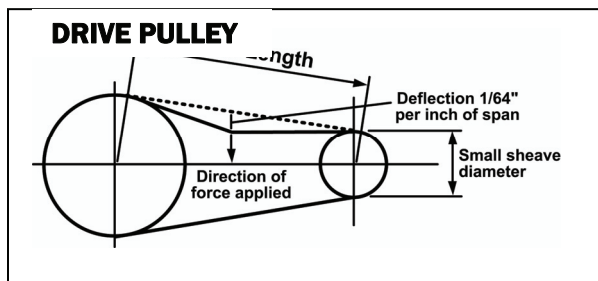

GUARDS: All mechanical action or motion is hazardous in varying degrees and needs to be guarded. Guards should be designed to achieve the required degree of protection and still allow full air flow from the compressor flywheel across the unit. Guards shall be in compliance with O.S.H.A. safety and health standards and any state or local codes. When the compressor is installed, make sure guard side is at least 18\" away from the wall to provide adequate cooling of motor and pump.

CHECK VALVES: Check valves are designed to prevent back-flow of air pressure in the compressed air system (air flows freely in one direction only.) The check valve must be properly sized for air flow and temperature. Do not rely upon a check valve to isolate a compressor from a pressurized tank or compressed air delivery system during maintenance procedures!

MANUAL SHUT-OFF VALVES: Manual shut-off valves block the flow of air pressure in either direction. This type of valve can be used to isolate a compressor from a pressurized system, provided the system is equipped with a safety relief valve capable of being manually released. The safety relief valve should be installed between the manual shut-off valve and the compressor.

SAFETY RELIEF VALVES: Safety relief valves aid in preventing system failures by relieving system pressure when compressed air reaches a determined level. A check valve and safety relief valve are required in all compressed air systems. Safety relief valves are preset by the manufacturer and under no circumstances should the setting be changed.

PRESSURE SWITCHES: The pressure switch detects the demand for compressed air and allows the motor to start. When the demand is satisfied, the unit stops and unloads the head pressure with a short hissing noise. Engine driven units use a pilot valve instead of a pressure switch. It will discharge compressed air to atmosphere or open the intake valve upon reaching a predetermined pressure setting.

PRESSURE VESSELS: ASME coded pressure vessels must not be modified, welded, repaired, reworked or subjected to operating conditions outside the nameplate ratings. Such actions will negate code status.

MAINTENANCE

Regular maintenance insures trouble-free operation. Your new compressor represents the finest engineering and construction available. However, even the finest machinery requires periodic maintenance. A good maintenance program will add years of service to your air compressor. The following is recommended as a minimum maintenance program. For your protection, disconnect power supply after each day's operation and drain air from system before performing any maintenance.

OIL TABLE

Temperature	0-40°	40° & Above
NON-DETERGENT – Straight Weight	10WT*	30WT*
*For maximum performance and service life, we recommend using ROLAIR Premium Quality compressor oil.		

Recommendation	Daily	Weekly	Monthly	Quarterly
Check Oil Level	X			
Drain Moisture from Tank(s)	X			
Inspect Air Filter(s)	X			
Check for Unusual Noise or Vibration	X			
Inspect Belt Guard	X			
Check for Air or Oil Leaks	X			
Clean Exterior of Air Compressor		X		
Check Condition of Vibration Pads		X		
Tighten/Retorque Bolts*		X		
Check Belt Tension		X		
Check Operation of Safety Valve		X		
Change Compressor Oil**			X	
Clean/Change Air Filter			X	
Perform Pump Up Time Test			X	
Check Operation of System Controls				X
Check Air Tanks for Dents/Leaks				X

*Check and retorque (see chart on pg. 7) only after pump has completely cooled to room temperature.
 **Always make sure crankcase vent (breather) is free and unobstructed when changing or checking oil.

MAINTENANCE HINTS:

- 1) Use a soap/water solution to check for air leaks.
- 2) Never clean filters with a flammable solvent.
- 3) Retorque head bolts only after pump has cooled.
- 4) Move motor 1/4" and roll belts back on to increase belt tension on electric units.
- 5) Never weld on air tank(s).
- 6) Use heat to loosen Loctite seal on drain valves, engine pulleys and flywheels before attempting to remove.

TORQUE CHART (INCH/LBS)

Determine pump type using suffix of model number (Example: V5180K30 uses a K30 pump.)

Pump Type	K17/K18	K24/K25	K28	K30	K35	K50	K60	K100
Head Bolts	243	243	347	347	347	694	347	694
Cylinder Bolts	182	182	330	330	330	521	330	521
Bearing Carrier Bolts	130	130	130	130	130	165	165	165
Connecting Rod Bolts	121.5	121.5	121.5	173.6	173.6	217	217	199.7
Flywheel	382	382	477	477	477	607	607	694

TROUBLESHOOTING

WARNING - Make sure you completely understand all of the safety warnings and operation of each system control component before attempting any maintenance or repair. Always drain the tank pressure completely, make sure the power cord is unplugged, and unit has time to cool before performing any maintenance or service operations.

PROBLEM	CAUSE	SOLUTION
Low discharge pressure	Air leaks	Correct air leaks
	Restricted air intake	Clean or replace intake element
	Loose/slipping belt(s)	Adjust belt tension
	Compressor too small	Perform pump-up time test
	Blown gasket	Replace head gaskets
	Broken valves/worn rings	Replace valve/rings
Knocking	Loose pulley/flywheel	Tighten appropriate item
	Loose belt(s)	Adjust belt tension
	Lack of oil in crankcase	Add oil
	Internal pump problem	Take pump in for service
Overheating	Poor ventilation	Relocate air compressor
	Dirty cooling surfaces	Clean compressor
	Incorrect flywheel rotation	Contact an electrician
	Blown gasket(s)	Replace head gaskets
	Broken valves	Replace valve/head gaskets
Excessive starting/stopping	Excessive air leaks	Correct air leaks
	Unit too small for application	Add/replace air compressor
	Air storage capacity too small	Add reserve air tank
Excessive belt wear	Motor pulley or flywheel out of alignment	Reposition pulley or flywheel
	Flywheel/pulley wobble	Replace appropriate item
	Improper belt tension	Adjust belt tension
Oil in discharge air or oil blowing out of crankcase vent	Wrong oil viscosity	Use correct type of oil
	Improper flywheel rotation	Contact an electrician
	Crankcase overfilled	Drain to proper oil level
	Obstructed crankcase breather	Clean or replace breather
	Inadequate ventilation	Relocate compressor
	Restricted air intake	Clean or replace intake element
	Worn piston rings	Take pump in for service
Water in crankcase (Oil appears milky in color)	Infrequent cycling	Install crankcase heater
	Incorrect or inferior oil	Use correct type of oil
Motor/compressor fails to attain speed	Loose belts	Correct belt tension
	Low voltage	Contact an electrician
	Improper wiring	Contact an electrician or factory
	Defective check valve	Replace check valve
	Motor overload	Push motor reset
	Inoperable relief valve	Replace pressure switch

NOTE: Reciprocating compressors consume a certain amount of oil under normal operation. If you are concerned about your oil consumption, monitor and record oil consumption daily before consulting your dealer. When oil consumption is normal and what appears to be milky oil is found in your lines, this is caused by small particles of oil, along with water vapor, condensing in your air lines. To eliminate this problem: Air-Cooled Aftercoolers, Refrigerated Dryers and Filters are available through your dealer.

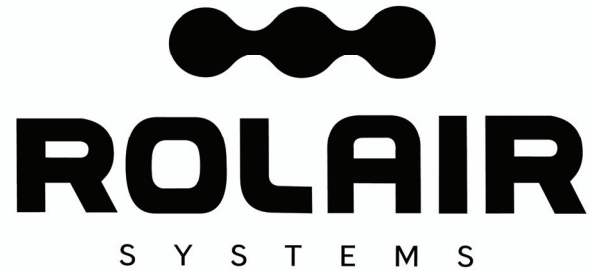

Guarantee

Associate Engineering Corporation warrants that all ROLAIR compressors will be free of defects in material and workmanship for a period of twelve months from the date of initial retail purchase, or eighteen months from the date of manufacture, whichever may occur first.

Should any failure to conform to this warranty be reported to the company within said period, the company shall, upon purchaser shipping the compressor to our plant transportation prepaid, correct such nonconformity by suitable repair or, at its option, furnish a replacement part F.O.B. our plant.

Associate Engineering Corporation shall not be liable for any unauthorized repairs, replacements, adjustments to the compressors, or the costs of labor performed by the purchaser.

This warranty is expressly in lieu of all other warranties expressed, implied or statutory (including, but not limited to, warranties of merchantability and fitness for purpose) and of any other obligations, and/or liabilities on the part of Associate Engineering Corporation. Associate Engineering Corporation neither assumes nor authorizes any other person to assume for it any other obligations or liability in connection with or with respect to any compressor.

Associate Engineering Corporation shall in no event be liable neither for any consequential, incidental or special damages nor for the improper selection of any compressor for a particular application.

Quality

Associate Engineering Corporation is devoted to continual quality control and thorough research of the products we build. It is our creed to give you, the user, all of the experience and engineering available in the production of every piece of equipment we produce.

Our line covers the complete needs of today's varied air requirements. Rely on ROLAIR for all the newest and finest features that are available for the modern compressor.





ROLAIR

SCHEMATIC FOR PMP22K28

PRODUCTION STARTING 2/00

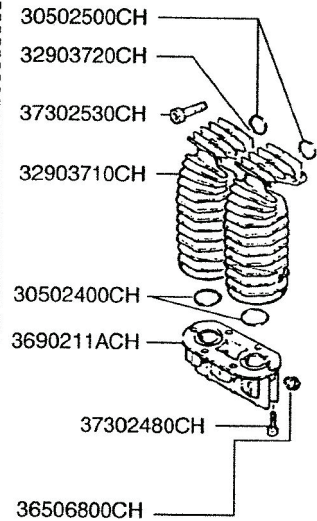

- 31004620CH
- 37500730CH
- 37400720CH

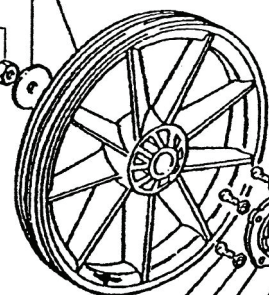

- 37301140CH
- 37508130CH
- 30400880CH
- 30500050CH
- 30300040CH
- 30300030CH

- 37308060CH
- 37502320CH
- 31302700CH
- 30502330CH
- 37302530CH
- 32902710CH
- 32902720CH
- 30502340CH
- 36902110CH
- 37302480CH
- 31204700CH
- 31204710CH
- 31204720CH
- 31206180CH
- 31204670CH
- 31102250CH
- 37300250CH
- 37500310CH
- 37400220CH
- 30204610CH
- 33104600CH

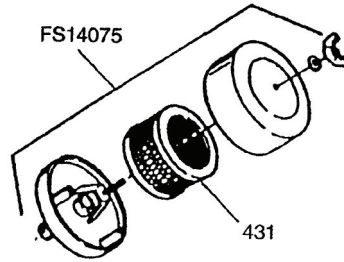

30502330CH

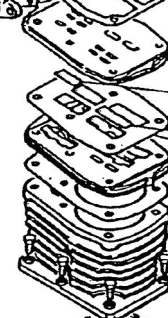
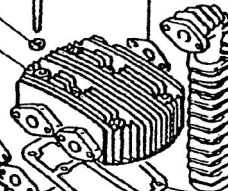

BLSQPL0250

- 37301140CH
- 37508130CH
- 30400830CH
- 30500150CH

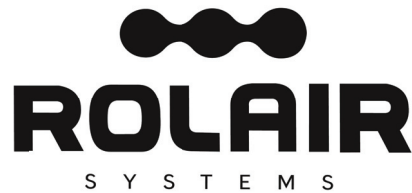

PARTS LIST FOR PMP22K28

Description	Part #	Qty.	Description	Part #	Qty.
Crankshaft	30204610CH	1	Valve Plate	32708710CH	2
Bearing	30300030CH	2	Left Intercooler	32902710CH	1
Oil Seal	30300040CH	1	Right Intercooler	32902720CH	1
Bearing Carrier	30400830CH	1	Aftercooler	32902730CH	1
Bearing Carrier	30400860CH	1	Crankcase	33104600CH	1
Gasket	30500050CH	1	Sight Gauge	36500140CH	1
Gasket	30500130CH	1	3/8" Breather/Oil Fill Plug	36507050CH	1
Gasket	30500150CH	1	Connector	3690211ACH	1
O-Ring	30509290CH	1	Bolt	37300250CH	4
Gasket	30502270CH	1	Bolt	37301140CH	14
Gasket	30502330CH	3	Bolt	37302480CH	6
Gasket	30502340CH	2	Bolt	37302530CH	6
Gasket	30504630CH	1	Bolt	37308060CH	6
Gasket	30508720CH	1	Nut	37400220CH	4
Gasket	30508730CH	1	Nut	37400720CH	1
Flywheel	31004620CH	1	Washer	37500310CH	4
Bearing Shell	31100210CH	2	Washer	37500730CH	1
Bushing*	31102250CH	2	Washer	37508130CH	14
Connecting Rod Assembly	31104840CH1	2	Snap Ring	37602260CH	4
Piston Pin - HP	31204670CH	1	Plug	BLSQPL0250	1
Ring - HP	31204700CH	2	Silencer/Filter Assembly	FS14075	1
Ring - HP	31204710CH	1	Filter Element	431	1
Ring - HP	31204720CH	1	Ring Set	K28RINGS	1
Piston - HP	31206180CH	1	Gasket Set	K28GASKETS	1
Piston - LP	31208750CH	1	Valve Plate Assembly	2800VK28	1
Ring - LP	31208760CH	1	INTERCOOLER/AFTERCOOLER PARTS STARTING 12/99		
Ring - LP	31208770CH	1	O-Ring - Connector	30502400CH	2
Ring - LP	31208780CH	1	Plug	36506800CH	1
Piston Pin - LP	31208790CH	1	Connector	3690211ACH	1
Head	31302700CH	1	Bolt	37302480CH	6
Cylinder	31608740CH	1	Bolt	37302530CH	6
Valve - HP	32700350CH	2	O-Ring - Head	30502500CH	2
Valve - LP	32703560CH	2			

*Bushing is not machined to fit piston pin if ordered separate from connecting rod.

