



**JOBSITE STORAGE SOLUTIONS**  
*ALWAYS ON THE JOB™*

# **INSTALLATION MANUAL**

**118-01 DATAVAULT**

**118-02 DATAVAULT - BARE**

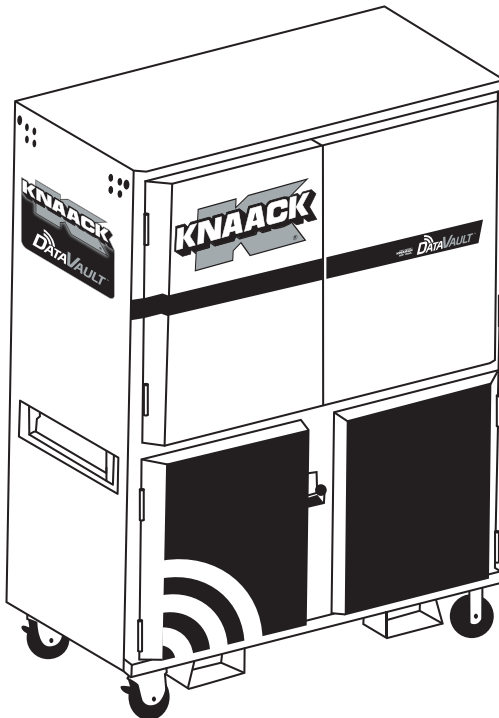

Werner Co.  
93 Werner Rd.  
Greenville, PA 16125

724-588-2000  
888-523-3371 toll free/ llamada gratuita  
888-456-8458 fax



## NOTICE

**ATTENTION: PLEASE READ AND UNDERSTAND ALL INSTRUCTIONS AND WARNINGS BEFORE ASSEMBLING, INSTALLING OR USING THIS PRODUCT.**

### Tools Required

- 9/16" SOCKET
- 9/16" WRENCH
- 5/16" SOCKET
- 7/16" SOCKET
- 7/16" WRENCH
- SCREWDRIVER, STRAIGHT BLADE
- SCREWDRIVER, PHILLIPS HEAD

### Parts List

- MODEL 500 POWER CREW \* QTY. 1
- MODEL 497 LIFT BRACKETS\* QTY. 1
- BRACKETS, SCREEN MTG. QTY. 2

### Bolt Kit #32-1180

- BOLT, M4 X18MM PHILLIPS HEAD QTY. 4
- BOLT, M4 X30MM PHILLIPS HEAD QTY. 4
- Bolt, M6 x 12MM PHILLIPS HEAD QTY. 4
- BOLT, M6 x 30MM PHILLIPS HEAD QTY. 4
- BOLT, M8 x 35MM PHILLIPS HEAD QTY. 4
- WASHER, LOCK ¼" QTY. 4
- WASHER, FLAT 1/4 QTY. 4
- WASHER, #10 QTY. 4
- WASHER, LOCK 5/16" QTY. 4
- SCREW, #10-24 x ¾" HEX HEAD QTY. 4
- BOLT, 1/4-20 x 5/8 HEX HD QTY. 2
- NUT, WHIZ 1/4-20 QTY. 2
- SHIM, HORSESHOE 1/16" THICK QTY. 12
- SHIM, HORSESHOE ¼" THICK QTY. 4

\* NOTE: FOR INSTALLING BOTH THE MODEL 500 POWER CREW, AND THE 497 LIFT BRACKETS, REFER TO THE INSTRUCTION SHEETS INSIDE EACH KIT.

### TV Specifications (not included in 118-02 but must meet these specs)

- 40" TV
- HXWXD – 25"X40"X4" MAX
- MINIMUM OF 2 HDMI PORTS
- VGA PORT (PC INPUT)

## Contents

I. INSTALLING A LARGE SCREEN.....	4
II. 3 POSITION HATCH FEATURE.....	6
a. Working Position .....	6
b. Open Position .....	6
c. Closed Position.....	6
III. LOCKABLE HATCH.....	7
IV. FILTERED FAN MOTOR .....	7
V. INSTALLING A PRINTER .....	8
VI. INSTALLING USB SWITCH .....	8
VII. INSTALLING POWER STRIPS.....	9
VIII. INSTALLING A COMPUTER .....	9
a. Tower Computer .....	9
b. Laptop.....	10
c. Tablet.....	10
IX. DRAWER ADJUSTING:.....	10
a. Drawer Removal and Installation.....	10
b. Drawer Slide Install.....	10
X. INSTALLING STRAPS:.....	11



**⚠ CAUTION**

Any modification or unintended use of this product shall immediately void all manufactures warranties. Manufacture disclaims all liability for injuries to persons or property resulting from any modification to, or unintended use of this product.

**⚠ CAUTION**

Prior to drilling to keep debris out of your eyes, always wear protective eye wear. Failure to head may result to death or serious injury.

### I. Installing A Large Screen

- a. Using the 5/16" socket remove the four #10-24 x 3/4" Hex head screws. Holding the acrylic window in place, Set window aside being careful not to scratch it. (SEE FIG. 1)

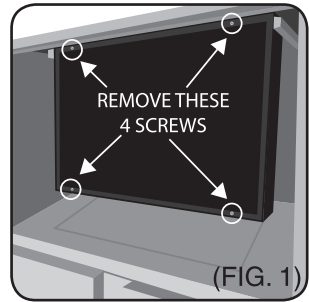

- b. Place screen to be installed face down on a flat surface. Install the two screen mounting brackets (SEE FIG. 2) to the back of the screen. Four M4, four M6, and four M8 bolts are provided to bolt the brackets to the screen. In the case that the back of the screen is not flat, spacers have been provided to create a flat surface. Also, the depth of TV mounting holes varies by model. Use spacers to shim brackets as necessary to prevent bolts from bottoming out. Place spacers as needed between the screen and the mounting bracket. (FIG. 2)

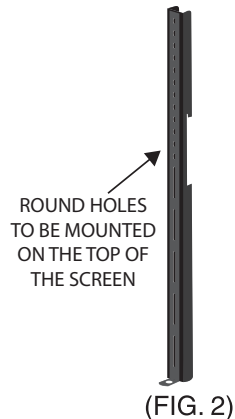

- c. Once screen has been mounted to the brackets, attach HDMI (2) and VGA(1) cables to the back of the screen (FIG.3).

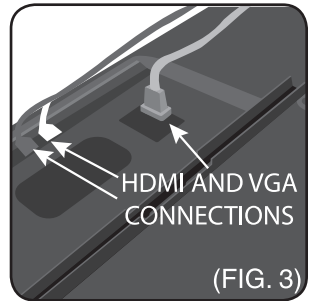

- d. Plug screen and fan power cords into extension cord (SEE FIG. 4). Route extension cord through cord pass through in back of enclosure. After enclosure installation, route extension cord through cable channel at rear of the 118 to the central compartment and plug into power strip. Switch on powerstrip may be turned on and off to control fan and screen power.

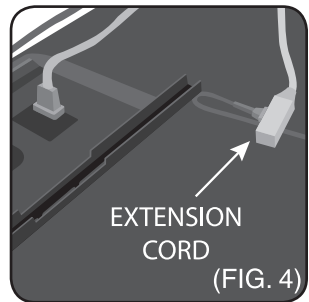

- e. Place screen onto the channel inside the enclosure. The channel has been pre-punched to accept all standard vesa mounting dimensions. Engage brackets with brackets mating to the slots on the channel. (SEE FIGURES 5 AND 6)

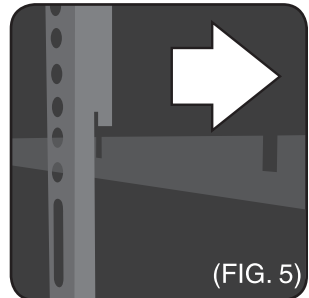

- f. Replace the window using the four screws and washers originally removed, along with four more provided inside the bolt kit. Be careful not to overtighten the screws.

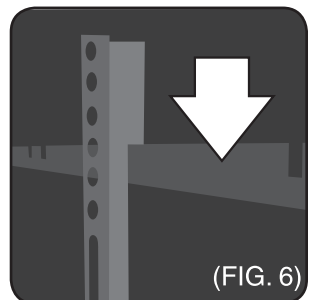

- g.** Attach screen mounting brackets through the corresponding holes in the bottom of the enclosure using two 1/4-20 x 5/8 bolts and 1/4-20 whiz nuts.

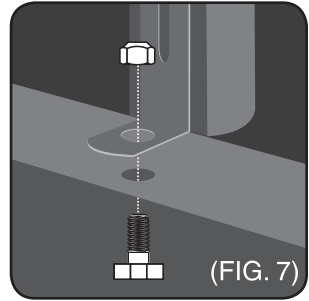

## II. 3 Position Hatch Feature

The keyboard hatch can be positioned in 3 places, working, open and closed.

### a. Working Position

With the rod placed fully forward, the keyboard will be level, while still providing a flat work surface above.

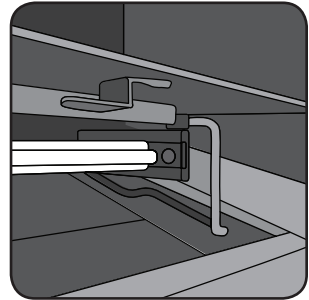

### b. Open Position

With the rod placed in notch, the hatch will be held open allowing you a larger access to items stored under the hatch.

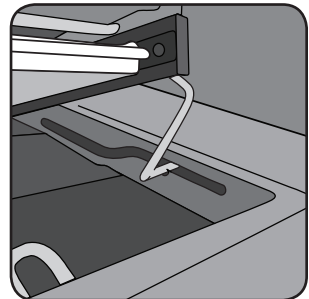

### c. Closed Position

Lift rod out of the notch and hold rod in location shown, slide the rod rearward to allow the hatch to close.

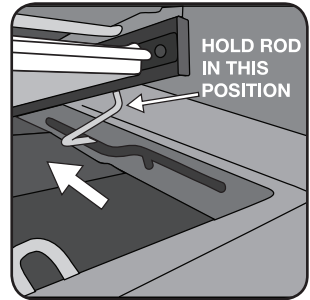

### III. Lockable Hatch

Hatch can be locked to protect valuables while momentarily away. Simply attach any padlock through the locking tab and loop of the rod.

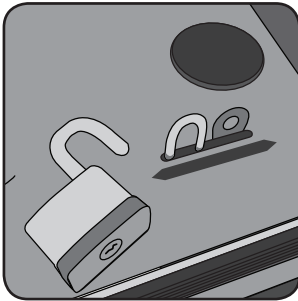

### IV. Filtered Fan Motor

#### CAUTION

**When fan is in use, the upper compartment doors must also be open to cool efficiently.**

A fan motor has been included inside the screen enclosure to help circulate air, and keep temperatures lower inside enclosure. This motor is filtered and will need occasional maintenance to keep filter clean.

a. Filter is located to the lower right side of enclosure.

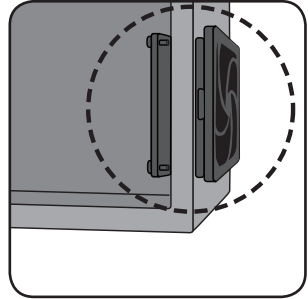
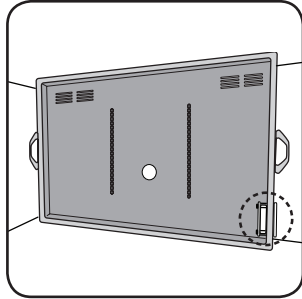

b. Un-snap filter cover as shown

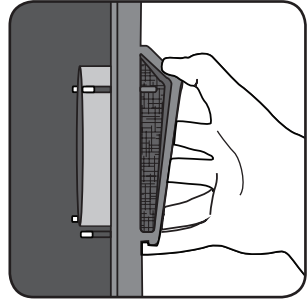

c. Remove cover and remove filter. Clean filter with water and squeeze out excess water before installing filter back onto fan. To avoid damaging the fan and screen, never run fan without the filter installed.

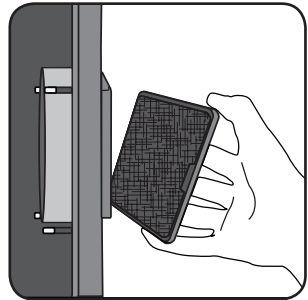

## V. Installing A Printer (printer not included in 118-02)

a. Install loose drawer into pre-installed drawer slides. Refer to drawer removal instructions on page 10.



- b. Plug the power cord and USB connection into back of printer and place printer on upper shelf in left compartment. Route the power cable through center dividing walls into compartment on right side. Plug power into UPS in the surge protector **without** battery backup.

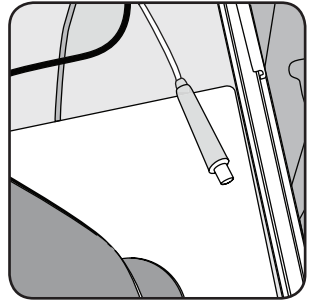

## VI. Installing USB Switch

(not included in 118-02)

Install USB switch in central compartment.  
Attach 2 USB-BM cables into switch.

- a. Install USB hub, connecting USB hub computer port/connector into USB switch.

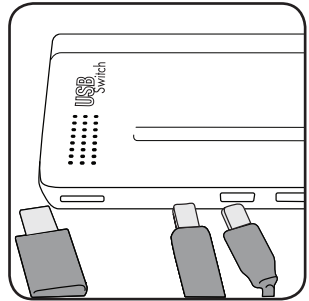

- b. Plug USB-AM cable (from printer) into USB hub.
- c. Other computer USB devices such as a keyboard and mouse may be installed at this time.

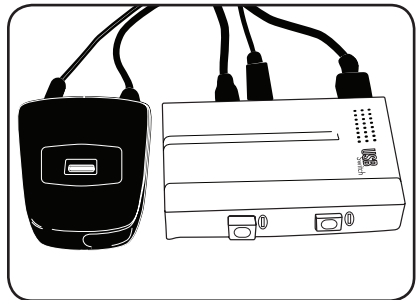

## VII. Installing Power Strips

(not included in 118-02)

- a. Install both power strips into the 118-01. Place one in the central compartment and route the cord through the cable channel to the lower compartment. Place the second in the lower compartment.
- b. Prior to installing the UPS power system, it needs to be charged for several hours.
- c. Install UPS device into right lower compartment on shelf.
- d. Plug the UPS power system into one of the GFCI slots in the powerstrip.
- e. Plug both power strips into UPS power system power backup and surge protection slots.

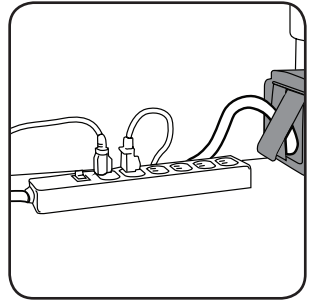

## VIII. Installing a Computer

### a. Tower Computer

Install tower computer on the lowest shelf in the left lower compartment. Route power cable through hole in the middle panel and plug into power strip. Connect USB and HDMI or VGA cable.

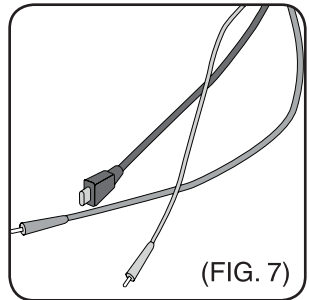

### b. Laptop

To use laptop, connect the HDMI and USB cables.

### c. Tablet

To use tablet, connect any necessary adapter to HDMI and connect to tablet.

## IX. Drawer Adjustment:

If you need to move any of the bottom drawers, to fit your printer or computer, follow these instructions:

### a. Drawer Removal and Installation

1. To remove a drawer (FIG. 8), pull the drawer out till it stops. Notice the locking levers located inside the track that is attached to the drawer. Lift lever (A) while pressing down on the right lever (B). Pull drawer clear of the sides.
2. To replace a drawer, simply insert the drawer slide into the cabinet slide and close the drawer completely. The mechanism will automatically latch.

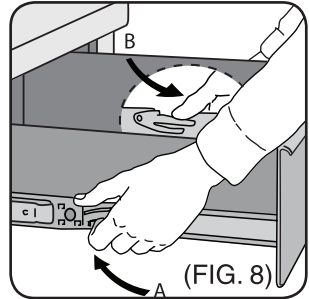

### b. Drawer Slide Install

1. Take one slide (FIG. 9) and insert the clips (inset) into the front and rear notches of the drawer support panel. Push the slide to the rear and down. Secure the slide through the end access hole in the slide.
2. Remove #6X1/2 screws to adjust locations of drawers.

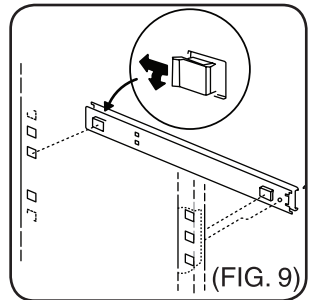

## X. Installing Straps

Straps have been provided to secure printer and power supply. Simply route strap through slots and pull until snug.

### CAUTION

***Pull out only one drawer at a time to avoid sudden tipping of product which could cause serious personal injury or property damage. For optimal weight distribution of unit, install large drawers in lower positions.***

***Notice: Any modification or unintended use of this product shall immediately void all manufacture's warranties. Manufacturer disclaims all liability for injuries to persons or property resulting from any modifications to, or unintended use of this product.***

**KnaackLLC**  
**ATTN:Warranty Claims**  
**420 E. Terra Cotta Avenue Crystal Lake, IL 60014**  
**[www.knaack.com](http://www.knaack.com)**

If you have any questions, please call toll free at 1-800-456-7856.

©2013 Knaack LLC

