

Operator's Manual**MODEL NUMBER: EATC608S**

Read and understand this manual before use.

Keep this manual for future reference.

WARNING: FOR YOUR OWN SAFETY, READ AND UNDERSTAND OPERATOR'S MANUAL. DO NOT RUN UNATTENDED. DO NOT PICK UP HOT ASHES OR COALS, TOXIC, FLAMMABLE OR OTHER HAZARDOUS MATERIALS. DO NOT USE AROUND EXPLOSIVE LIQUIDS OR VAPORS.



Intertek
3084514
CONFORMS TO UL
STD. 1017
Certified to CSA STD.
C22.2 No.243-10

www.cleva-na.com
Cleva North America, Inc.
601 Regent Park Court
Greenville, SC 29607 USA

Replacement Filters &
Accessories available at
Vacmaster.com

TABLE OF CONTENTS

SECTION	PAGE
Warranty.....	2
Safety Instructions & Warnings.....	3
Double Insulation Instructions.....	4
Extension Cords.....	4
Getting To Know Your Ash Vacuum.....	5
General Assembly Instructions.....	6
LED Work Light Use.....	7
Ash Vacuuming Operation.....	8
Blower Operation.....	9
Filter Maintenance.....	10
Machine Labels & Warnings.....	11
Troubleshooting.....	11
Accessories.....	11
Exploded View & Parts List.....	12

WARRANTY

We take pride in producing a high quality, durable product. This product carries a two (2) year limited warranty against defects in workmanship and materials from date of purchase under normal household use. If product is to be used for commercial, industrial, or rental use, a 90 day limited warranty will apply. Warranty does not apply to defects due to direct or indirect abuse, negligence, misuse, accidents, repairs, alterations, or lack of maintenance. Please keep your receipt as proof of purchase. This warranty gives you specific legal rights, and you may have other rights, which vary from state to state. For product service call Customer Service at 1-866-384-8432.

IMPORTANT! Check that the vacuum cleaner has not been damaged in shipment, and all accessories are included. Read the Operator's Manual completely before attempting to operate this unit. Save these instructions for your future reference.

SAFETY INSTRUCTIONS & WARNINGS

IMPORTANT SAFETY INSTRUCTIONS

Read and understand all instructions before using this vacuum

Read and understand this manual and all labels on the Ash Vacuum before operating. Safety is a combination of common sense, staying alert and knowing how your vacuum works. Use this Ash Vacuum only as described in this manual. To reduce the risk of personal injury or damage to your Ash Vacuum, use only recommended accessories.

For Household Use Only.

SAVE THIS MANUAL FOR FUTURE REFERENCE.



This vacuum is intended for removing loose, cool ash from the ash collection areas of stoves and fireplaces. Do not vacuum soot. Soot is a combustible material generally found in deposits along exhaust areas and chimneys.

Do not vacuum up hot, burning, or red hot objects (e.g. cigarettes, charcoal, ashes)

The temperature of the vacuuming material must be below 100°F (40°C). If it exceeds 100°F (40°C), there is a risk of fire.

CAUTION: Never use this product for vacuuming liquids. Only use this unit to vacuum dry dust material!

WARNING: TO REDUCE THE RISK OF FIRE, ELECTRIC SHOCK OR INJURY:

- Do not run vac unattended.
- Do not vacuum, or use this Ash Vacuum near flammable liquids, gases, or explosive vapors like gasoline or other fuels, lighter fluids, cleaners, oil-based paints, natural gas, hydrogen, or explosive dusts like coal dust, magnesium dust, grain dust, or gun powder. Sparks inside the motor can ignite flammable vapors or dust.
- Do not vacuum anything that is burning or smoking, such as cigarettes, matches, or hot ashes.
- Keep cord away from heated surfaces.
- Do not expose to rain. Store indoors.
- Do not unplug by pulling on cord. To unplug, grasp the plug, not the cord.
- Do not use with damaged cord, plug or other parts.
- If the appliance is not working as it should, has missing parts, has been dropped, damaged, left outdoors, or dropped into water, return it to a service center.
- Do not pull or carry by cord, use cord as handle, close a door on cord, or pull cord around sharp edges or corners.
- Do not run over the cord.
- Do not handle plug or the Ash Vacuum with wet hands.
- To reduce the risk of health hazards from vapors or dusts, do not vacuum toxic materials.
- Do not use or store near hazardous materials.
- Do not use this vacuum with a torn filter or without the filter installed.
- Do not allow to be used as a toy. Close attention is necessary when used by or near children.
- To reduce the risk of injury from accidental starting, unplug power cord before changing or cleaning filter.
- Do not leave the vacuum unattended when plugged in. Unplug from outlet when not in use and before servicing.
- The use of the vacuum can result in foreign objects being blown into the eyes. Always wear safety goggles complying with ANSI Z87.1 (or in Canada CSAZ94.3) when operating vacuum.
- Turn off the Ash Vacuum before unplugging.
- Do not put any object into ventilation openings. Do not vacuum with any ventilation openings blocked; keep free of dust, lint, hair or anything that may reduce air flow.
- Keep hair, loose clothing, fingers, and all parts of body away from openings and moving parts.

ATTENTION: Vacuuming materials, which appear to have cooled down, may still be very hot inside. Hot ash particles may ignite again with airflow. Wait until the fire is extinguished and the ashes have cooled down before you begin cleaning. It is not recommended to quickly extinguish the fire with water. Please make sure that ashes are cold before you vacuum. Temperature exceeding 100°F (40°C) may damage the vacuum cleaner and the components included. Continuously check hose, ash filter, and vacuum cleaner for excessive

temperatures during operation. If you notice a temperature rise, switch off the vacuum cleaner immediately and disconnect it from the power outlet. Take the vacuum outside and remove the power head.

CAUTION: In case of excessive temperatures, the hose, filter, or vacuum cleaner may be damaged. Completely empty the vacuum cleaner and brush off the ash filter in a safe, well ventilated area after vacuuming. Let both items (vacuum cleaner and ash filter) cool down under supervision.

DOUBLE INSULATION INSTRUCTIONS

This Ash Vacuum is double-insulated, eliminating the need for a separate grounding system. Use only identical replacements parts. Read the instructions for Servicing Double-Insulated Ash Vacuums before servicing. Use this Ash Vacuum as described in this manual. Observe the following warnings that appear on the motor housing of your Vac.



DOUBLE-INSULATED - GROUNDING NOT REQUIRED - WHEN SERVICING USE ONLY IDENTICAL REPLACEMENT PARTS.

WARNING: TO REDUCE THE RISK OF ELECTRIC SHOCK-DO NOT EXPOSE TO RAIN. STORE INDOORS.

WARNING: FOR YOUR OWN SAFETY, READ AND UNDERSTAND OPERATOR'S MANUAL. DO NOT RUN UNATTENDED. DO NOT PICK UP HOT ASHES, COALS, TOXIC, FLAMMABLE OR OTHER HAZARDOUS MATERIALS. DO NOT USE AROUND EXPLOSIVE LIQUIDS OR VAPORS.

WARNING: SERVICING OF DOUBLE-INSULATED APPLIANCE
 WITH A DOUBLE-INSULATED VACUUM, TWO SYSTEMS OF INSULATION ARE PROVIDED INSTEAD OF GROUNDING. NO GROUNDING MEANS IS PROVIDED ON A DOUBLE-INSULATED APPLIANCE, NOR SHOULD A MEANS FOR GROUNDING BE ADDED. SERVICING A DOUBLE INSULATED VACUUM REQUIRES EXTREME CARE AND KNOWLEDGE OF THE SYSTEM, AND SHOULD BE DONE ONLY BY QUALIFIED SERVICE PERSONNEL. REPLACEMENT PARTS FOR A DOUBLE-INSULATED VACUUM MUST BE IDENTICAL TO THE PARTS THEY REPLACE. YOUR DOUBLE-INSULATED VACUUM IS MARKED WITH THE WORDS 'DOUBLE INSULATED' AND THE SYMBOL (SQUARE WITHIN A SQUARE) MAY ALSO BE MARKED ON THE APPLIANCE.

- To reduce the risk of electric shock-unplug before cleaning or servicing.
- DO NOT use without filters in place.

CAUTION: TO REDUCE THE RISK OF INJURY FROM MOVING PARTS- UNPLUG BEFORE SERVICING.

EXTENSION CORDS

When using an extension cord with your Vacuum refer to the following table to determine the required A.W.G. wire size. Before using the Ash Vacuum, make sure the power cord and extension cord are in good working conditions. Make repairs or replacements before using the vacuum cleaner. Only use extension cords that are rated for outdoor use.

	Length of Extension Cord			
	25 Feet 7.5 Meters	50 Feet 15.25 Meters	100 Feet 30.5 Meters	150 Feet 45.7 Meters
110V-120V				
Amps	A.W.G. Wire Size			
0-6	18	16	16	14
7-10	18	16	14	12
11-12	16	16	14	12
13-16	14	12	Not recommended	

GETTING TO KNOW YOUR ASH VACUUM

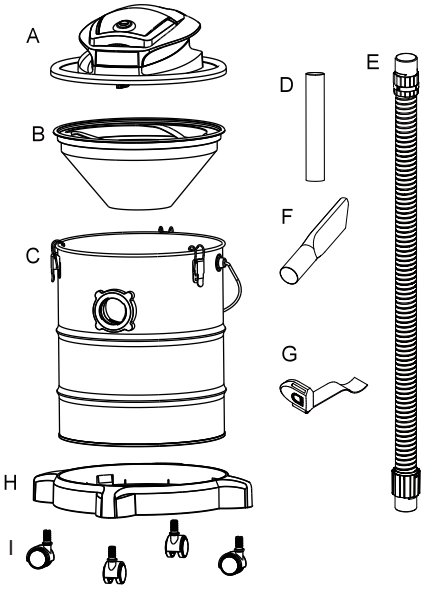

Remove entire contents of carton. Check each item against the carton contents list.

Key	Description	QTY
A.	Power Head	1
B.	Ash Filter	1
C.	Tank	1
D.	Aluminum Wand	1
E.	Aluminum Hose	1
F.	Aluminum Crevice Tool	1
G.	LED Work Light	1
H.	Base	1
I.	Casters	4

NOTE: The hose and accessories for this ash vacuum are 1-1/2 inch (38.1mm) diameter.

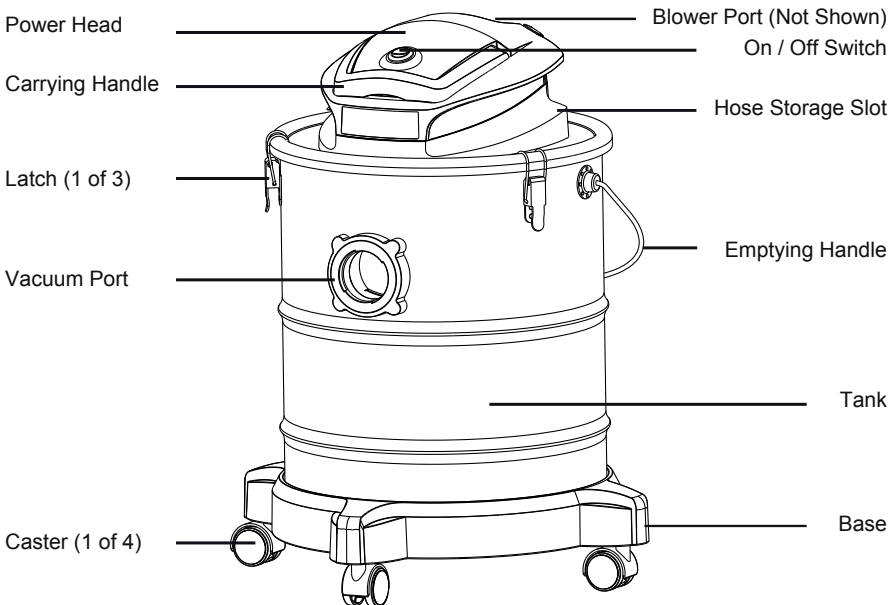

GENERAL ASSEMBLY INSTRUCTIONS

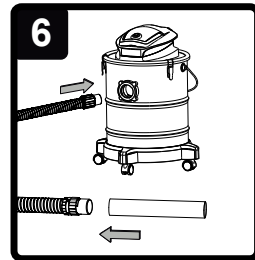
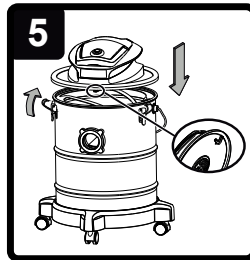
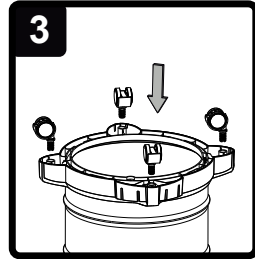
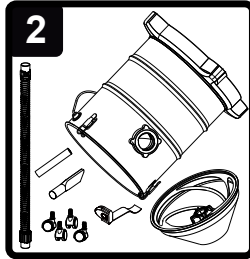

1. Remove the Ash Vacuum from the package.
2. Unlock the latches and remove the power head lid. (Fig. 1)
3. Remove the contents from inside the tank and make sure you have all the parts listed on page 5. (Fig. 2)
4. Turn the container upside down, and insert the casters on to the four feet of the container base. Ensure that they are mounted correctly and "snap" into place. (Fig. 3)
5. Place the filter onto the rim of the tank. Make sure the edge of the filter fits snugly along the edge of the tank. (Fig. 4)
6. With the filter installed, place the power head onto the container and secure it with the latches. (Fig. 5)
7. Insert the hose into the vacuum port and connect the metal intake nozzle into the other end of the hose.(Fig. 6)

LED WORK LIGHT USE

When vacuuming in a dark room or in the corner of a fireplace or stove, the LED Work Light can help shed some light on the work area.

Attach the LED Work Light to the crevice tool or wand with the included hook and loop strap, and switch it on when you need more light. (Fig. 1 & Fig. 2)

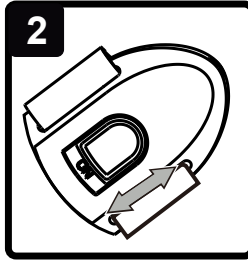
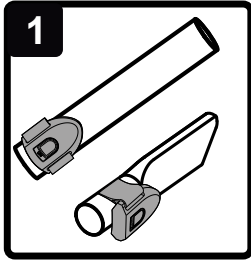

There are two replaceable button cell batteries in the LED Work Light. You can change them by yourself when the LED is turned off.

Use only a CR 2016 3V button cell battery with your LED Work Light.

Use a properly size of slotted screwdriver to open the battery cover.

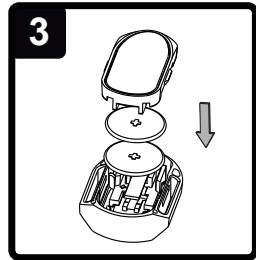
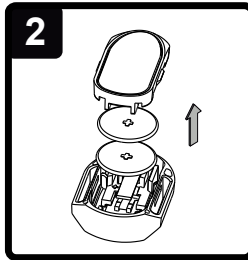
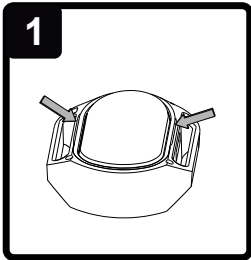

1. Insert the screwdriver into the slot on both sides of battery cover (Fig. 1) and remove the battery cover.
2. Carefully replace both button cell batteries with a new set of batteries. (Fig. 2)
3. Close the cover by pressing the cover into the LED work light housing with proper force. (Fig. 3)
4. Check if the battery cover is closed and the light turns on and off.

CAUTION! This product contains a button battery. If swallowed, it could cause severe injury or death in just 2 hours. Seek medical attention immediately!

ASH VACUUMING OPERATION

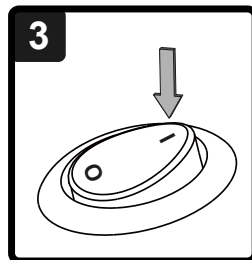
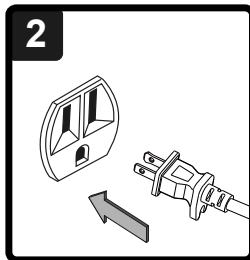
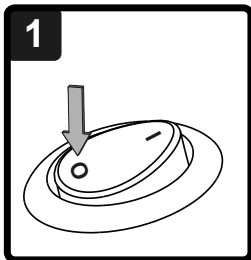

1. Make sure all parts are in place.
Never use ash vacuum without the filter in place.
Never use ash vacuum without the metal nozzle or crevice tool in place.
2. Make sure the power switch is in the "0" (OFF) position (Fig. 1).
3. Plug the power cord into the outlet, then turn on the ash vacuum by flipping the switch to the "I" (ON) position. (Fig. 2 & Fig. 3)
4. Run the unit for 30 seconds after you have finished cleaning your stove or fireplace to ensure all materials are safely captured in the container.
5. Once you have finished vacuuming, flip the switch to the "0" (OFF) position and unplug the power plug.

POLARIZED PLUG

To reduce the risk of electrical shock, this appliance has a double polarized plug (with one blade wider than the other). This plug will fit in a polarized outlet only one way. If the plug does not fit fully in the outlet, reverse the plug. If it still does not fit, contact a qualified electrician to install the proper outlet. Do not change the plug in any way. Double insulation eliminates the need for the three wire grounded power cord and grounded power supply system.

WARNING: BE SURE TO READ, UNDERSTAND, AND APPLY INFORMATION, ENTITLED 'SAFETY INSTRUCTIONS & WARNINGS'. DO NOT VACUUM IN AREAS WITH FLAMMABLE GASES, VAPORS, OR EXPLOSIVE DUSTS IN THE AIR. FLAMMABLE GASES OR VAPORS INCLUDE BUT ARE NOT LIMITED TO: LIGHTER FLUID, SOLVENT TYPE CLEANERS, OIL-BASE PAINTS, GASOLINE, ALCOHOL, OR AEROSOL SPRAYS. EXPLOSIVE DUSTS INCLUDE BUT ARE NOT LIMITED TO: COAL, MAGNESIUM, GRAIN, OR GUN POWDER. TO REDUCE THE RISK OF HEALTH HAZARDS FROM VAPORS OR DUST, DO NOT VACUUM TOXIC MATERIALS.

BLOWER OPERATION

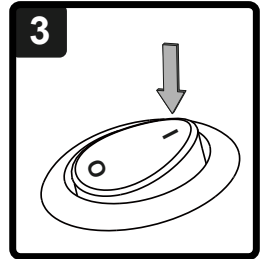
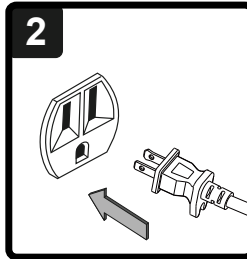
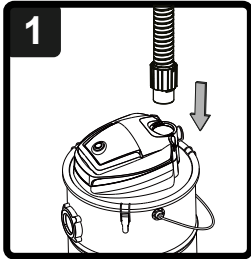

This ash vacuum has blowing capabilities.

To use the blower feature follow the instructions listed.

1. Insert the large end of the hose into the blower connection in the top of the motor housing. (Fig. 1)
2. Ensure the power switch is turned to the "0" (OFF) position, then plug the power cord into the electrical outlet. (Fig. 2)
3. Turn the motor on by flipping the switch to the "I" (ON) position. (Fig. 3)
4. The unit will now blow through the vacuum hose. This can be used to clear obstructions in the hose, or to convert the vacuum to a blower. (Fig. 4)

WARNING!

ALWAYS WEAR SAFETY GOGGLES BEFORE USING BLOWER.

KEEP BYSTANDERS CLEAR FROM BLOWING DEBRIS.

WEAR A DUST MASK IF BLOWING CREATES DUST THAT MIGHT BE INHALED.

FILTER MAINTENANCE

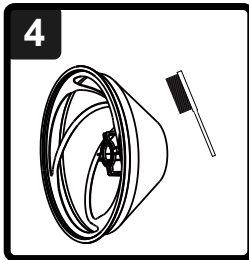
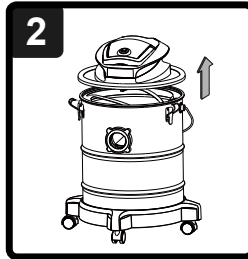
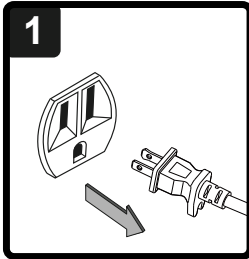

WARNING: ALWAYS DISCONNECT THE PLUG FROM THE POWER OUTLET BEFORE REMOVING THE POWER HEAD FROM CONTAINER.

REMOVING AND CLEANING THE FILTER

1. Verify that the power cord is disconnected from the outlet. (Fig. 1)
2. Remove power head. (Fig. 2)
3. Carefully Remove the filter from the container. (Fig. 3)
4. Clean the ash or dirt from the filter by gently tapping or brushing the ash or dirt off. (Fig. 4)

IMPORTANT! CLEANING SHOULD NOT BE DONE INDOORS IN LIVING AREAS. FOR OPTIMAL PERFORMANCE A NEW FILTER IS RECOMMENDED.

MACHINE LABELS & WARNINGS



Before using, read this manual carefully and make sure you have understood all the warnings, instructions and controls.



Do not use in rain. Store indoors, to reduce the risk of electrical shock.

TROUBLESHOOTING

WARNING: TO REDUCE THE RISK OF ELECTRIC SHOCK-UNPLUG BEFORE TROUBLESHOOTING

Symptom	Possible Causes	Corrective Action
Vacuum will not operate.	1) Lack of power.	1) Check power supply – cord, breakers, fuses.
	2) The filter is not installed correctly onto the micro-switch	2) Check the filter assembly and make sure it is against the switch.
	3) Container full.	3) Empty container and clean or replace filters.
Dust comes out from motor cover.	1) The filter is damaged or installed incorrectly.	1) Reinstall or replace filter.
Reduced efficiency and motor/speed vibration.	1) There is a blockage in the hose, or the container inlet. The cartridge filter is clogged by fine dust.	1) Check hose and container inlets for blockage. Take off the filter and clean it. Or install a new cartridge filter.

ACCESSORIES

Only use manufacturer approved accessories and spare parts. The use of original accessories and original spare parts ensures that the appliance can be operated safely and trouble free. For accessories call Customer Service at 1-866-384-8432.

EXPLODED VIEW & PARTS LIST

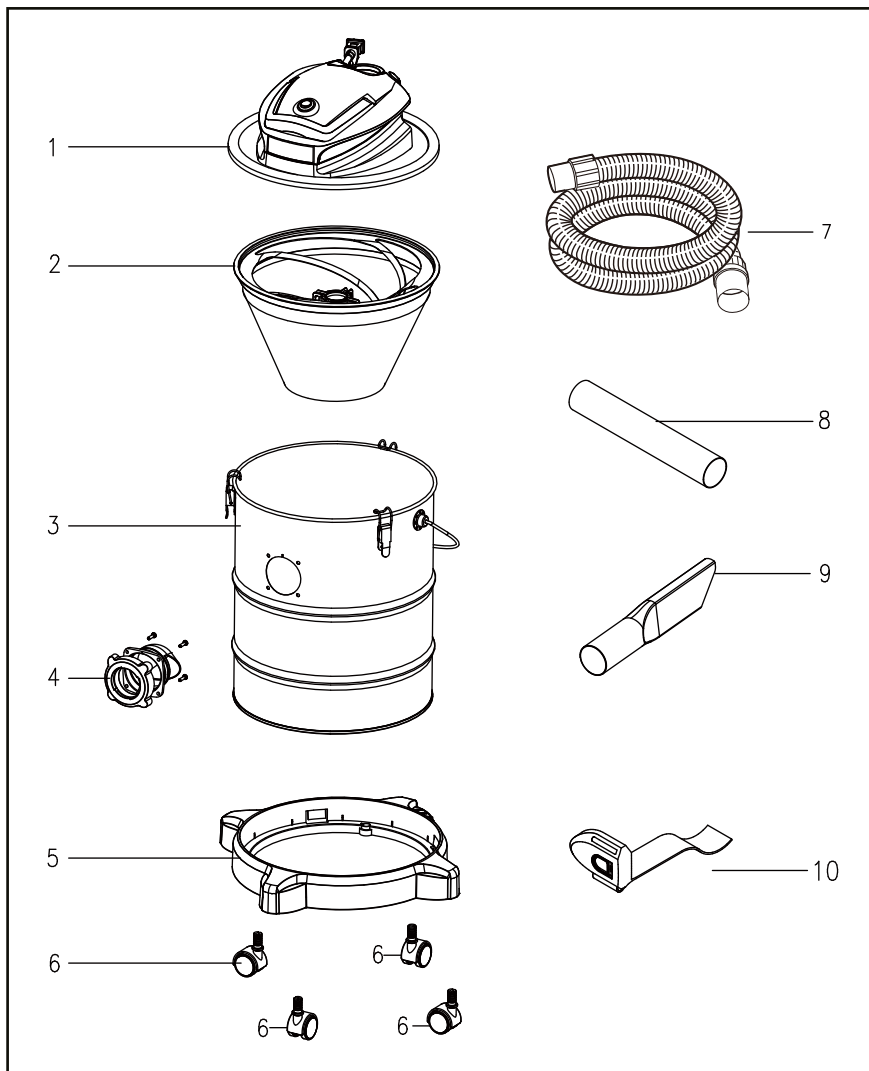

Ash Vac Manual Parts List

Part	Drawing Number	Description	Quantity	Part	Drawing Number	Description	Quantity
1	551166102	Power Head Assembly	1	6	551021122	Caster	4
2	AVPF3	Ash Filter Assembly	1	7	551166105	Aluminum Hose	1
3	551166104	Collection Tank	1	8	551104116	Aluminum Wand	1
4	551163107	Vacuum Port Assembly	1	9	551166106	Aluminum Crevice Tool	1
5	551038112	Base	1	10	VLED	LED Work Light	1